

SERIES: CREEK OPTUS

BRAND: i-LèD

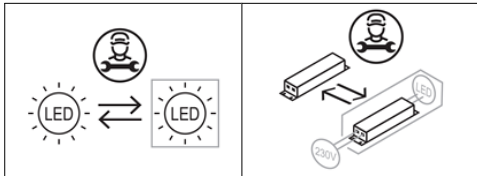
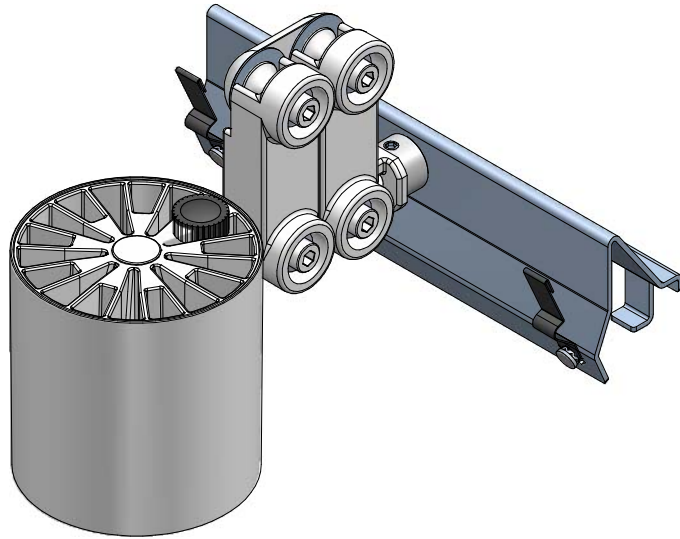
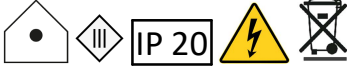

## Installazione / Manutenzione

L'articolo dovrà essere installato da personale qualificato, **seguendo le normative d'installazione vigenti del paese di appartenenza**; In caso di malfunzionamento o necessità di manutenzione dell'articolo contattare il servizio clienti Linea Light tramite la seguente mail: [support@linealight.com](mailto:support@linealight.com).

**SONO SEVERAMENTE VIETATE LE OPERAZIONI DI INSTALLAZIONE E MANUTENZIONE DELL'ARTICOLO MENTRE QUEST ULTIMO È IN FUNZIONE: !!! ATTENZIONE !!! DUARANTE IL FUNZIONAMENTO ALCUNE PARTI DELL'APPARECCHIO POSSONO RAGGIUNGERE TEMPERATURE ELEVATE.**

## Installation / Maintenance

The article must be installed by qualified personnel, **following the installation regulations in force in your country**; In the event of malfunction or need for maintenance of the article, contact Linea Light customer service via the following e-mail: [support@linealight.com](mailto:support@linealight.com).

**IT IS STRICTLY FORBIDDEN TO INSTALL AND MAINTAIN THE ARTICLE WHILE IT IS IN OPERATION; !!! WARNING !!! DURING OPERATION, CERTAIN PARTS OF THE APPLIANCE MAY REACH HIGH TEMPERATURES.**

**LINEA LIGHT declines any kind of responsibility** if the instructions provided in the following instruction manual and in the main manual present in the article's packaging are not followed.

## UTILIZZO CONFORME:

L'apparecchio è garantito esclusivamente se l'articolo in questione sia stato installato seguendo le istruzioni riportate in questo manuale di istruzioni e da quello generale presenti all'interno dell'imballaggio e scaricabili dal sito: [www.linealight.com](http://www.linealight.com); **In caso di mancata osservazione delle precedenti avvertenze, l'azienda LINEA LIGHT declinerà ogni tipologia di responsabilità.**

Un utilizzo scorretto dell'articolo può influire nella durata utile della lampada e/o potrebbe causarne un guasto precoce. Evitare la pulizia dell'apparecchio utilizzando agenti chimici aggressivi, è sufficiente passare l'articolo con uno straccio inumidito con acqua. Per ulteriori avvertenze e/o spiegazioni di eventuali simboli si prega di visionare il foglio istruzioni generale.

**CONSERVARE LE PRESENTI ISTRUZIONI PER FUTURI LAVORI DI INSTALLAZIONE/MANUTENZIONE.**

## COMPLIANT USE:

The luminaire is only guaranteed if the article in question has been installed in accordance with the instructions given in this instruction manual and the general manual found inside the packaging and downloadable from: [www.linealight.com](http://www.linealight.com); **In the event of failure to comply with the above warnings, LINEA LIGHT declines all liability.**

Incorrect use of the article may affect the service life of the lamp and/or cause it to fail prematurely. Avoid cleaning the fixture using harsh chemicals, simply wipe the item with a cloth dampened with water. For further warnings and/or explanations of possible symbols please refer to the general instruction sheet.

**KEEP THESE INSTRUCTIONS FOR FUTURE INSTALLATION/MAINTENANCE WORK.**

**(ITA)** - I prodotti devono essere installati tassativamente con alimentazioni, cablaggi e accessori originali del Gruppo Linea Light, o eventualmente approvati dall'azienda. L'utilizzo di accessori non originali, o non approvati, determina il decadimento di ogni garanzia sul prodotto. **(ENG)** - All power supply, wiring and accessories used for product installation shall be original Linea Light Group parts or approved by the company. The warranty will become void if non original or non approved parts are used. **(FRA)** - Les produits doivent impérativement être installés avec des alimentations, des câblages et des accessoires Linea Light Group, ou qui ont été approuvés par l'entreprise. L'utilisation d'accessoires non d'origine, ou non approuvés, entraîne la déchéance de toute garantie sur le produit. **(ESP)** - Los productos se han de instalar obligatoriamente con alimentaciones, cableados y accesorios originales de Linea Light Group o, de otra forma, deben ser aprobados por la empresa misma. El uso de accesorios no originales, o no aprobados, anula todas las garantías del producto. **(GER)** Die Produkte müssen obligatorisch mit Originalstromversorgung, Originalkabeln und Originalzubehör der Linea Light Group oder mit Teilen, die von der Linea Light Group ausdrücklich empfohlen sind, installiert werden. Die Verwendung von nicht originale oder nicht vom Hersteller empfohlenem Zubehör führt zu einem sofortigen Verfall vom Garantieanspruch für das Produkt.

SERIES: CREEK OPTUS

BRAND: i-LED

### MODELLI / MODELS

CODE	Dimension s ( $\varnothing \times H$ mm)	POWER (W)	CLASS III		WEIGHT (Kg)	CRI	Energy class light source			No. light source
			VOLTAGE (V)	CURRENT (mA)			Temperature color LED (K°)			
							2700	3000	4000	
C01133	$\varnothing 66 \times 256$	8,5	12	700	0,6	90	F	F	F	1
82731	$\varnothing 66 \times 256$	15	37,5	400	0,6	90	E	E	E	1
82732	$\varnothing 66 \times 256$	15	37,5	400	0,6	90	E	E	E	1
82733	$\varnothing 90 \times 280$	24	34,5	700	0,85	90	E	E	E	1
82734	$\varnothing 90 \times 280$	24	34,5	700	0,85	90	E	E	E	1
82735	$\varnothing 105 \times 295$	34	36	950	1,05	90	E	E	E	1
82736	$\varnothing 105 \times 295$	34	36	950	1,05	90	E	E	E	1



\*NON FISSARE LA SORGENTE LUMINOSA.  
\*DO NOT STARE AT LIGHT SOURCE.

Ta -20°C ÷ +50°C

### INSTALLAZIONE / INSTALLATION

1

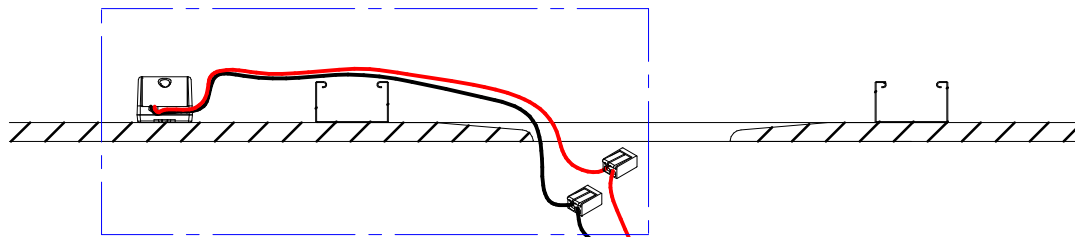

A

PROFILO NON INCLUSO  
(82728/82729/82730)  
(per foro ed installazione vedi LED-FGI810)  
PROFILE NOT INCLUDED  
(82728/82729/82730)  
(for hole and installation see LED-FGI810)

DRIVER NON  
INCLUSO  
DRIVER NOT  
INCLUDED

Positive (+) = red  
(not included)

MORSETTI NON  
INCLUSI  
TERMINALS NOT  
INCLUDED

Negative (-) = black  
(not included)

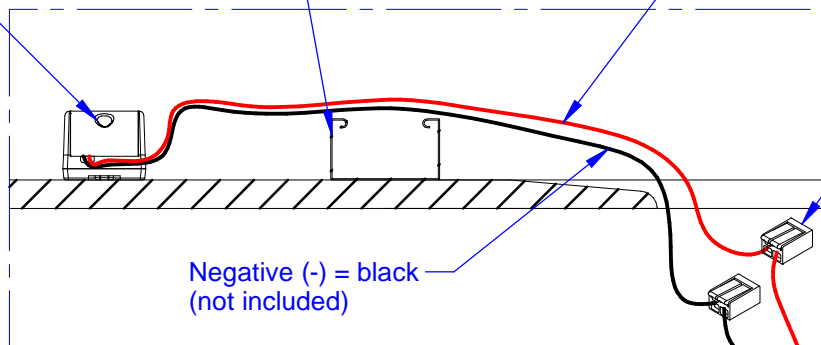

DETTAGLIO A

SERIES: CREEK OPTUS

BRAND: i-LèD

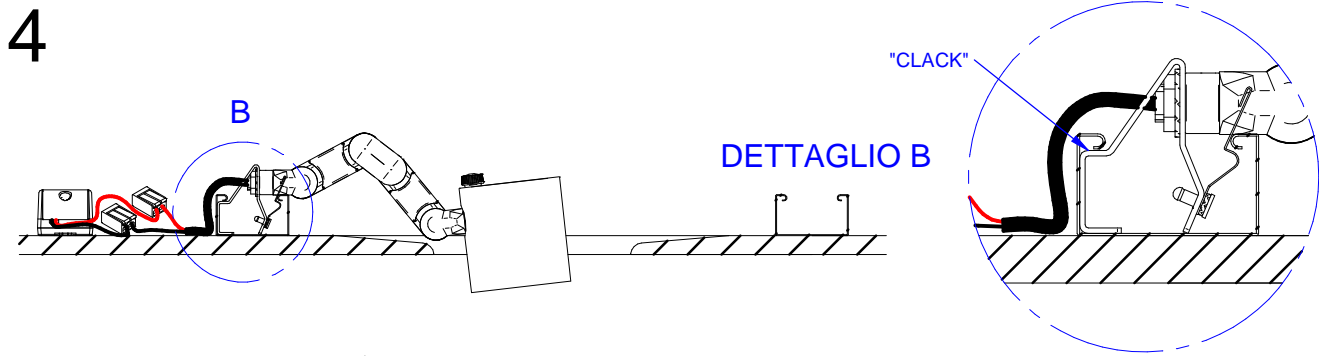
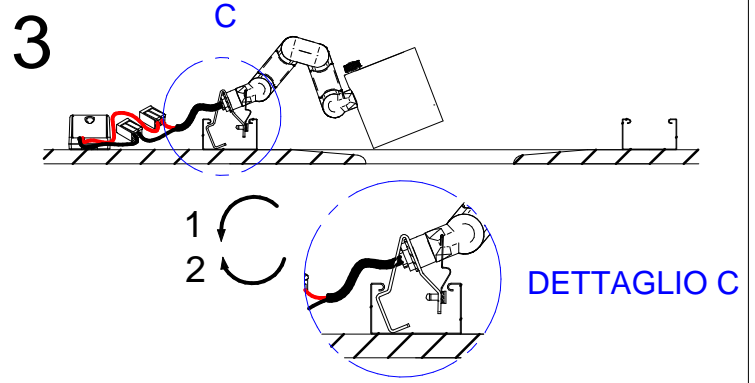
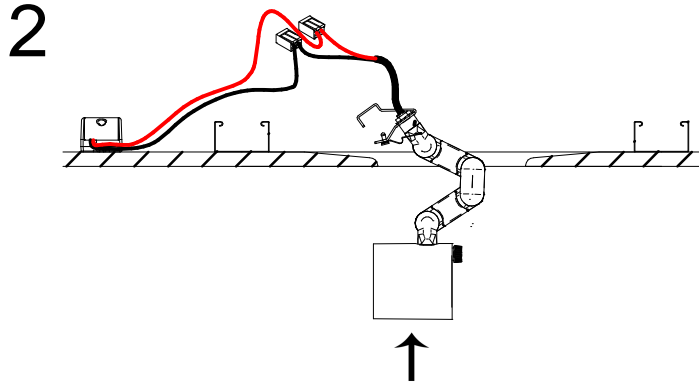

art 99927

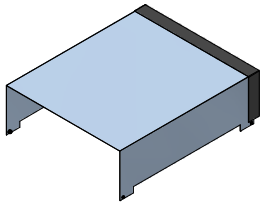

art 99928

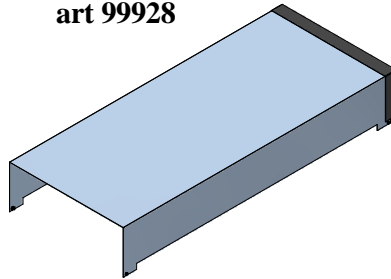

art 99929

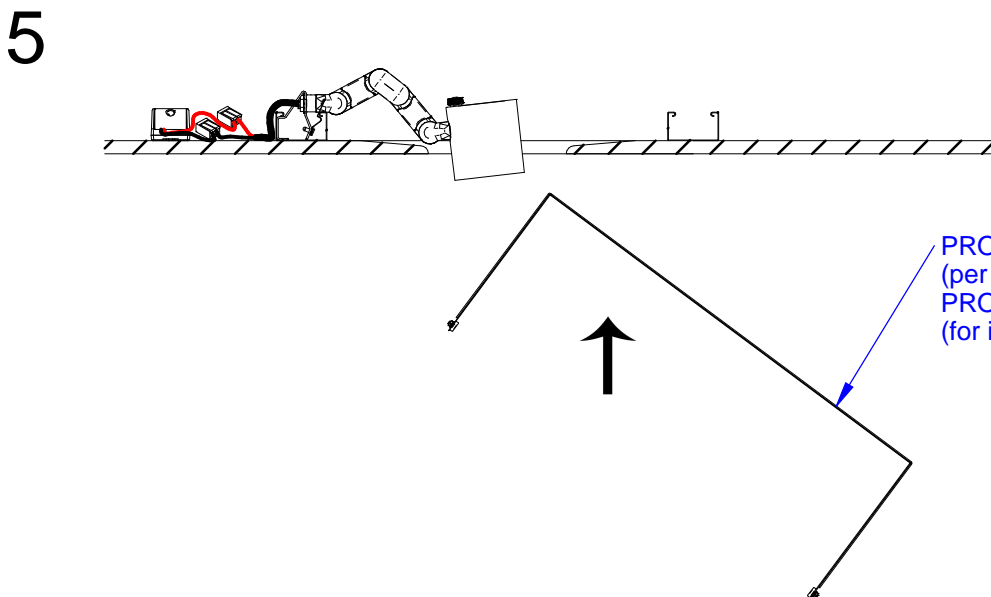
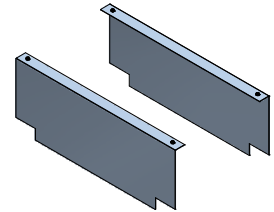

SERIES: CREEK OPTUS

BRAND: i-LèD

6

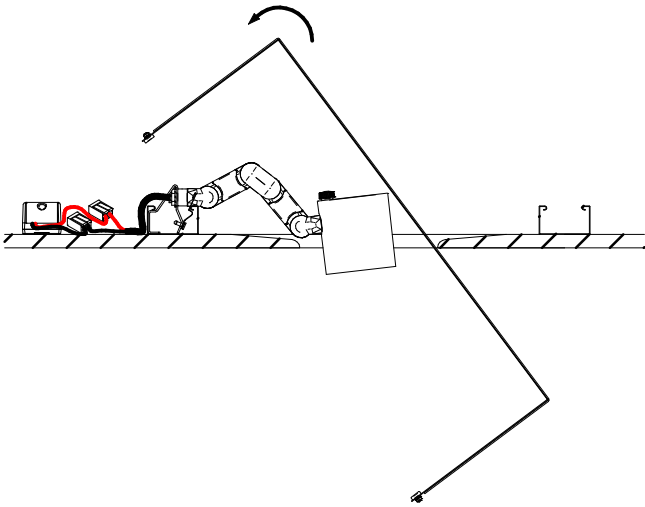

7

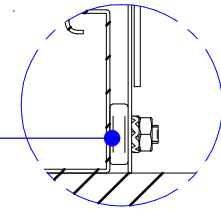
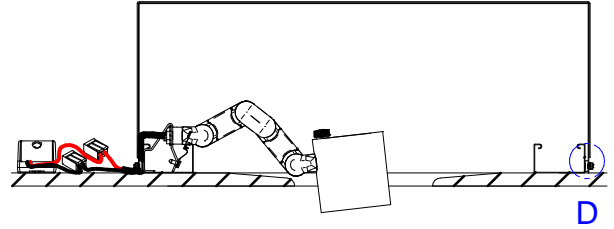

DETTAGLIO D

8

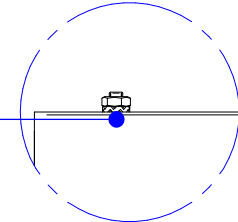
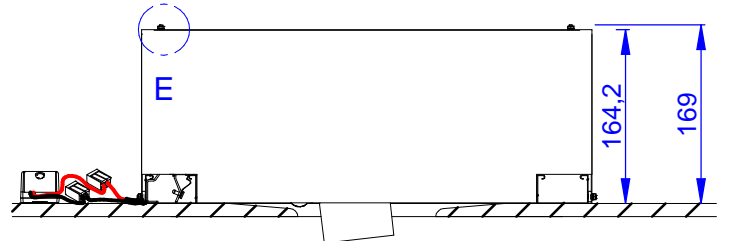
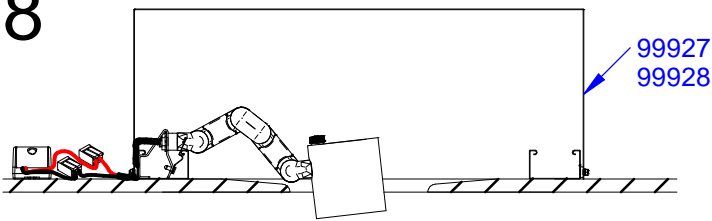

DETTAGLIO E

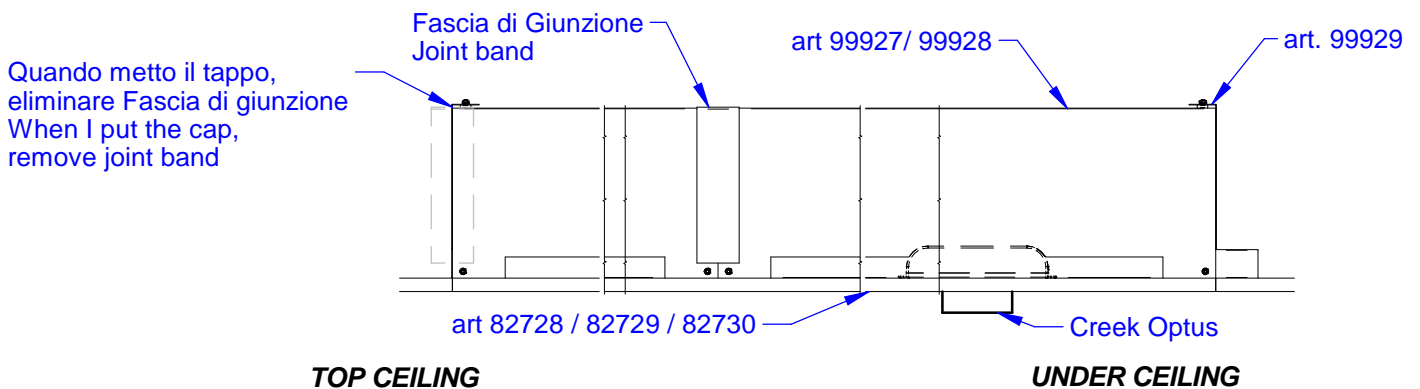
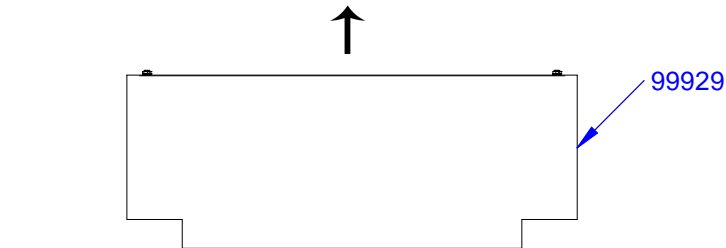

220-240 V

Positive (+) = red

Negative (-) = black

**SERIES: CREEK OPTUS**

**BRAND: i-LèD**

I	GB	F	D	E
<p><b>Procedura di cablaggio</b></p> <p>1 Chiudere l' interruttore generale <b>OFF</b></p> <p>2 Collegare i faretti all' alimentatore</p> <p>3 Collegare l' alimentatore alla rete</p> <p>4 Aprire l' interruttore generale <b>ON</b></p> <p>N.B.</p> <p>Tutte le operazioni di manutenzione ed installazione vanno eseguite con l' interruttore generale in posizione <b>OFF</b></p> <p>Non collegare più faretti in parallelo all' uscita dello stesso alimentatore</p> <p>I faretti necessitano di corrente costante stabilizzata</p> <p>Per il N° di led collegabili all' alimentatore seguire le indicazioni sull'etichetta dello stesso</p> <p><b>IL FARETTO RISULTA GARANTITO SOLO CON ALIMENTATORI DISTRIBUITI DA i-LèD</b></p>	<p><b>Wiring procedure</b></p> <p>1 Switch off the main switch <b>OFF</b></p> <p>2 Connect the spotlights to the power supply unit.</p> <p>3 Connect the power supply unit to the network</p> <p>4 Switch on the main switch <b>ON</b></p> <p>N.B.</p> <p>All the maintenance and installation procedures must be carried out with the main switch in position <b>OFF</b></p> <p>Do not connect too many parallel spotlights to the output of the same power supply unit</p> <p>Use stabilized constant current for the spotlights</p> <p>Follow the instructions on the label of the power supply unit for the number of spotlights that can be connected to it</p> <p><b>SPOTLIGHTS ARE GUARANTEED ONLY IF POWER SUPPLY UNITS DISTRIBUTED BY i-LèD ARE USED</b></p>	<p><b>Procédure de câblage</b></p> <p>1 Couper le disjoncteur <b>OFF</b></p> <p>2 Relier les spots au driver</p> <p>3 Relier le driver au réseau</p> <p>4 Connecter le disjoncteur <b>ON</b></p> <p>N.B.</p> <p>Toutes les opérations de maintenance et d'installation seront effectuées avec le disjoncteur sur la position <b>OFF</b></p> <p>Ne pas relier plusieurs spots en parallèle sur la sortie du même driver</p> <p>Les spots nécessitent d'un courant constant stabilisé</p> <p>Pour le N° de leds reliables au driver, suivre les indications reportées sur son étiquette</p> <p><b>LE SPOT EST GARANTI SEULEMENT AVEC LES DRIVERS DISTRIBUES PAR i-LèD</b></p>	<p><b>Anleitung zur Verkabelung</b></p> <p>1 Schalten Sie den Hauptschalter aus <b>OFF</b></p> <p>2 Schliessen Sie die Strahler an dem Stromversorgungsgeraet an</p> <p>3 Schliessen Sie das Stromversorgungsgeraet ans Netz an</p> <p>4 Schalten Sie den Hauptschalter ein <b>ON</b></p> <p>N.B.</p> <p>Die Wartungs - und Instandhaltungsvorgänge müssen mit Hauptschalter in Position durchgeführt werden <b>OFF</b></p> <p>Schalten Sie weiterhin keinen Strahler mehr parallel am Ausgang desselben Stromversorgungsgeräts</p> <p>Die Strahler brauchen Konstantstrom</p> <p>Beachten Sie die Etikette des Stromversorgungsgeräts, um die Anzahl der am Stromversorgungsgerät anzuschliessenden LED zu erfahren.</p> <p><b>DIE GARANTIE IST GÜLTIG NUR FÜR STRAHLER, DIE MIT i-LèD STROMVERSORUNGSGERÄTEN EINGESPEIST WERDEN.</b></p>	<p><b>Procedimiento de cableado</b></p> <p>1 Cerrar el interruptor general <b>OFF</b></p> <p>2 Conectar los focos al alimentador</p> <p>3 Conectar el alimentador a la red</p> <p>4 Abrir el interruptor general <b>ON</b></p> <p>N.B.</p> <p>Todas las operaciones de mantenimiento e instalación se tendrán que llevar a cabo con el interruptor general en posición <b>OFF</b></p> <p>No conectar má focos en paralelo a la salida del mismo alimentador</p> <p>Los focos necesitan corriente constante estabilizada</p> <p>Sobre el N° de leds conectables al alimentador seguir las indicaciones indicadas en la etiqueta del mismo</p> <p><b>EL FOCO SÓLO ESTÁ GARANTIZADO CON ALIMENTADORES DISTRIBUIDOS POR i-LèD</b></p>

**(ITA)** - I prodotti devono essere installati tassativamente con alimentazioni, cablaggi e accessori originali del Gruppo Linea Light, o eventualmente approvati dall'azienda. L'utilizzo di accessori non originali, o non approvati, determina il decadimento di ogni garanzia sul prodotto. **(ENG)** - All power supply, wiring and accessories used for product installation shall be original Linea Light Group parts or approved by the company. The warranty will become void if non original or non approved parts are used. **(FRA)** - Les produits doivent impérativement être installés avec des alimentations, des câblages et des accessoires Linea Light Group, ou qui ont été approuvés par l'entreprise. L'utilisation d'accessoires non d'origine, ou non approuvés, entraîne la déchéance de toute garantie sur le produit. **(ESP)** - Los productos se han de instalar obligatoriamente con alimentaciones, cableados y accesorios originales de Linea Light Group o, de otra forma, deben ser aprobados por la empresa misma. El uso de accesorios no originales, o no aprobados, anula todas las garantías del producto. **(GER)** Die Produkte müssen obligatorisch mit Originalstromversorgung, Originalkabeln und Originalzubehör der Linea Light Group oder mit Teilen, die von der Linea Light Group ausdrücklich empfohlen sind, installiert werden. Die Verwendung von nicht originale oder nicht vom Hersteller empfohlenem Zubehör führt zu einem sofortigen Verfall vom Garantieanspruch für das Produkt.

**LEGENDA COLORI CAVI / COLOR CABLE LEGEND**

- RED (Rosso) = + / POSITIVE (+ / Positivo)
- BLACK (Nero) = - / NEGATIVE (- / Negativo)

**CABLAGGIO CL3 / CL3 WIRING**

**Collegamento in serie a driver in corrente costante / Series connection to constant current drivers**

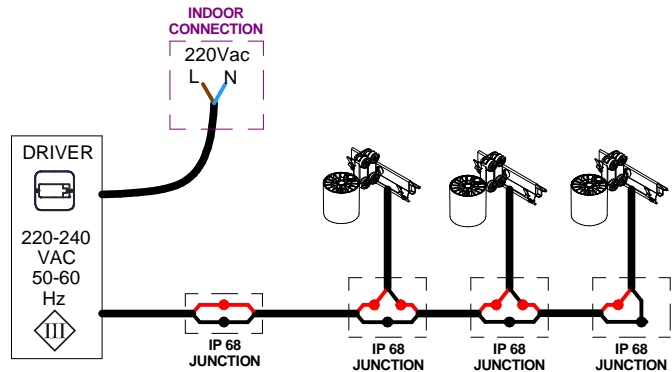

**ACCESSORI / ACCESSORIES**

<p><b>A.</b></p> <p><b>99781</b> for 16W <b>99797</b> for 24W <b>C-U300013</b> for 34W</p>	<p><b>B.</b></p> <p><b>99779</b> for 16W <b>99799</b> for 24W <b>C-U300031</b> for 34W</p>	<p><b>C.</b></p> <p><b>99782</b> for 16W <b>99795</b> for 24W <b>C-U300030</b> for 34W</p>	<p><b>D.</b></p> <p><b>99780</b> for 16W <b>99798</b> for 24W</p>	<p><b>E.</b></p> <p><b>99841</b> for Focal kit <b>99844</b> <b>99842</b> for Focal kit <b>99843</b> <b>C-U300014</b> for 34W Focal kit <b>C-U300034</b></p>
<p><b>F.</b></p> <p><b>99783</b> for 16W <b>99796</b> for 24W <b>C-U300029</b> for 34W</p>				