

















| L260  | L390  |
|---|---|
|  9669  |  9672  |
|  9669M |  9672M |
|  9670  |  9673  |
|  9670M |  9673M |
|  9671  |  9674  |
|  9671M |  9674M |
|  9933  |  9936  |
|  9933M |  9936M |



1  
L390

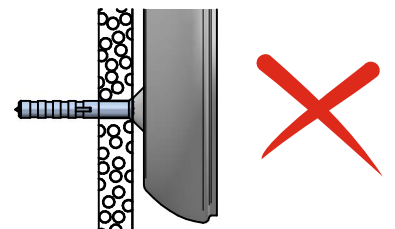
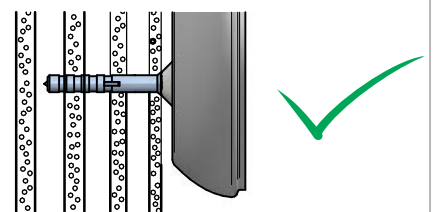
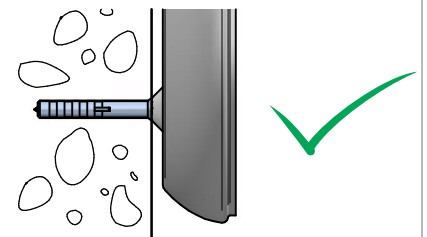
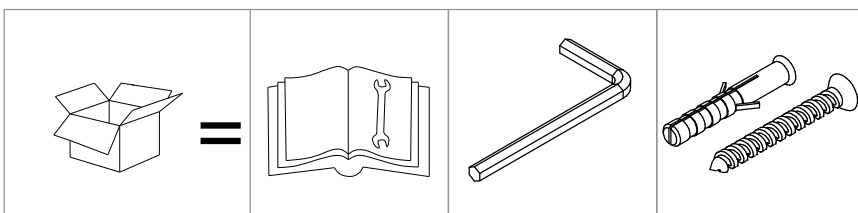
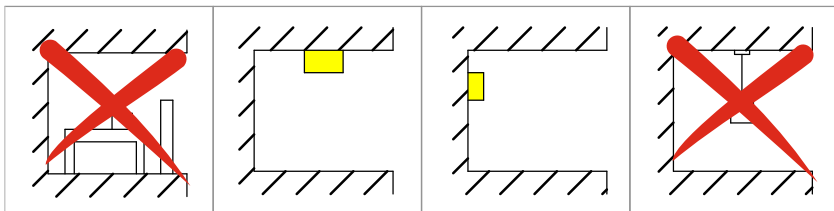
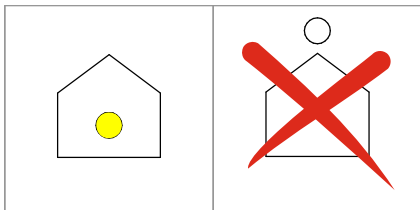
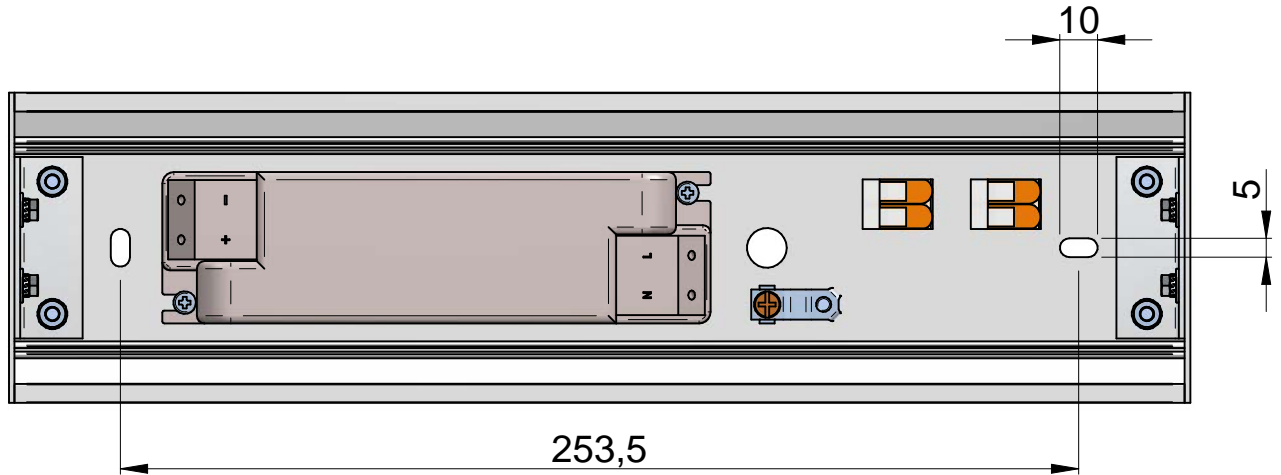

L260

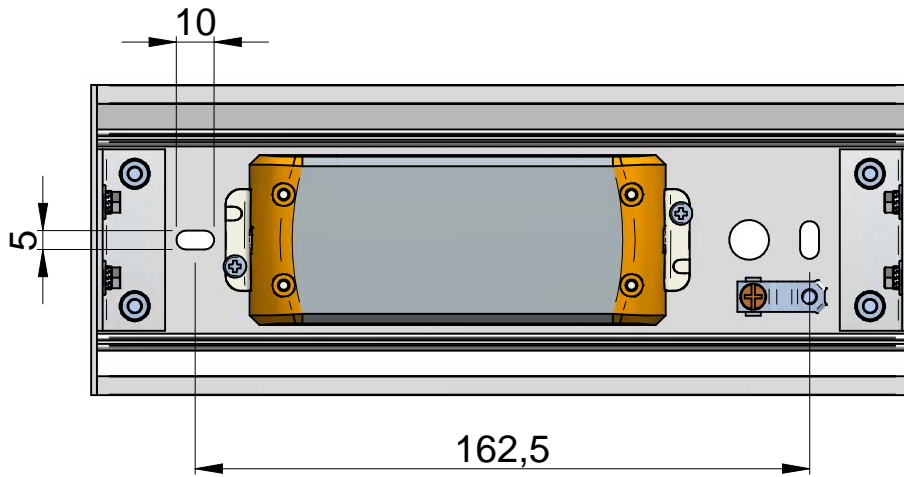

2

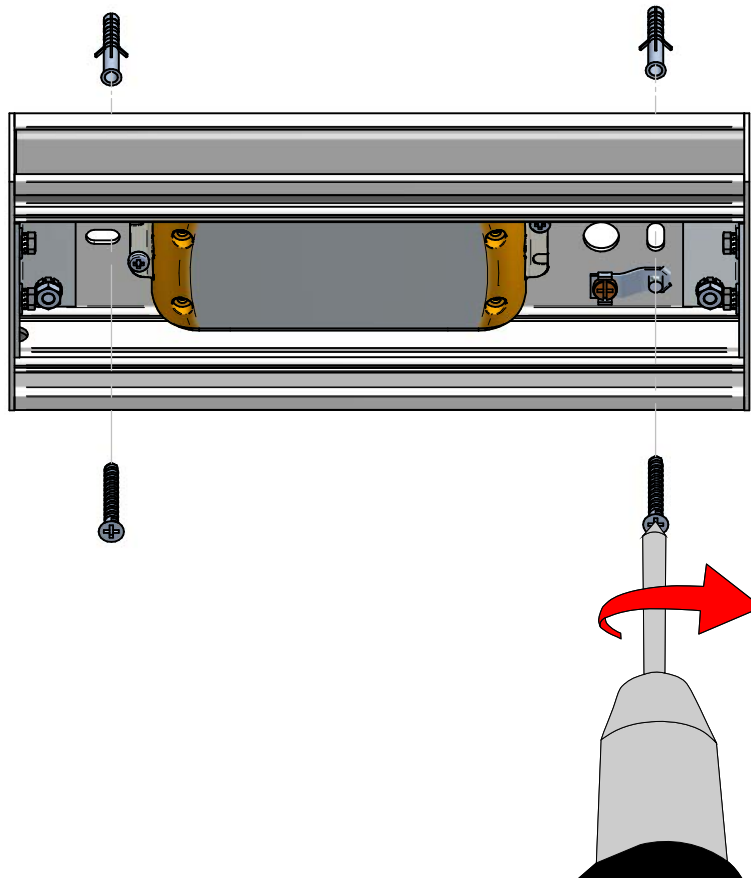

3  
L260

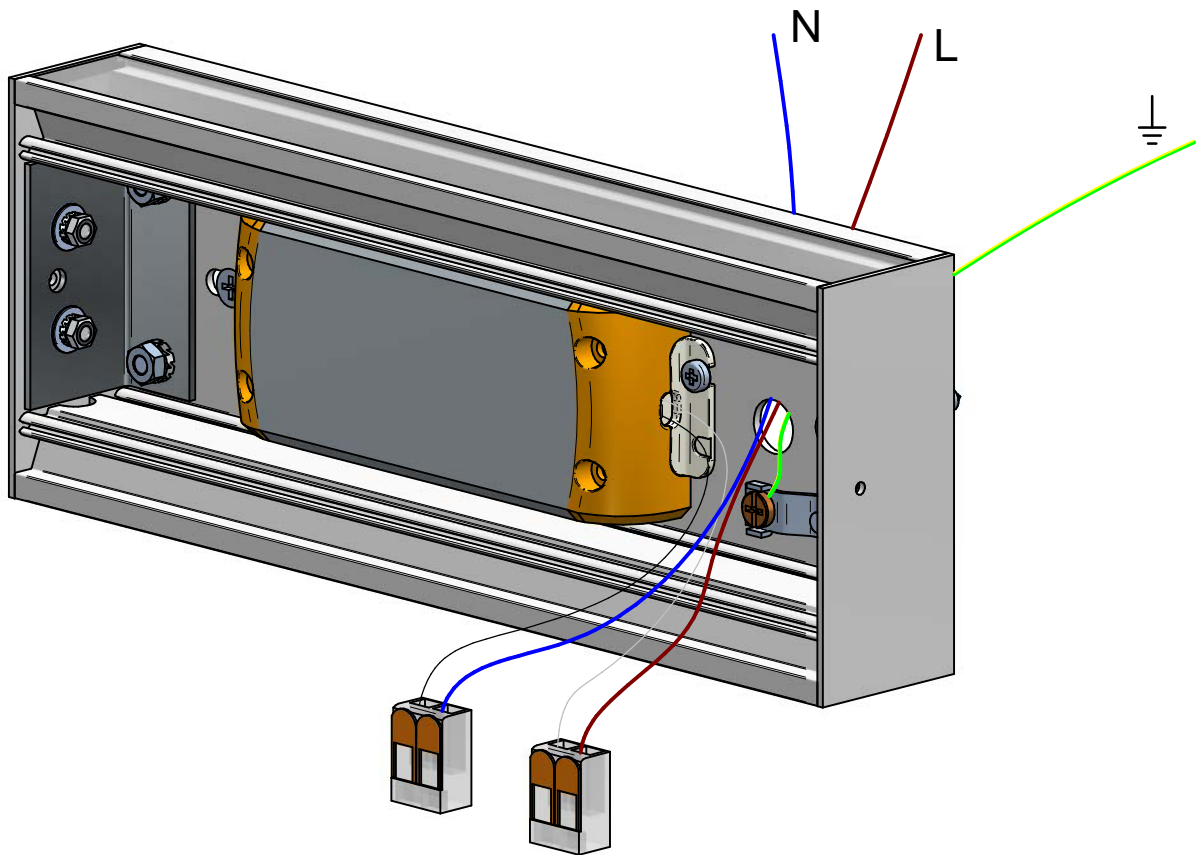

L390

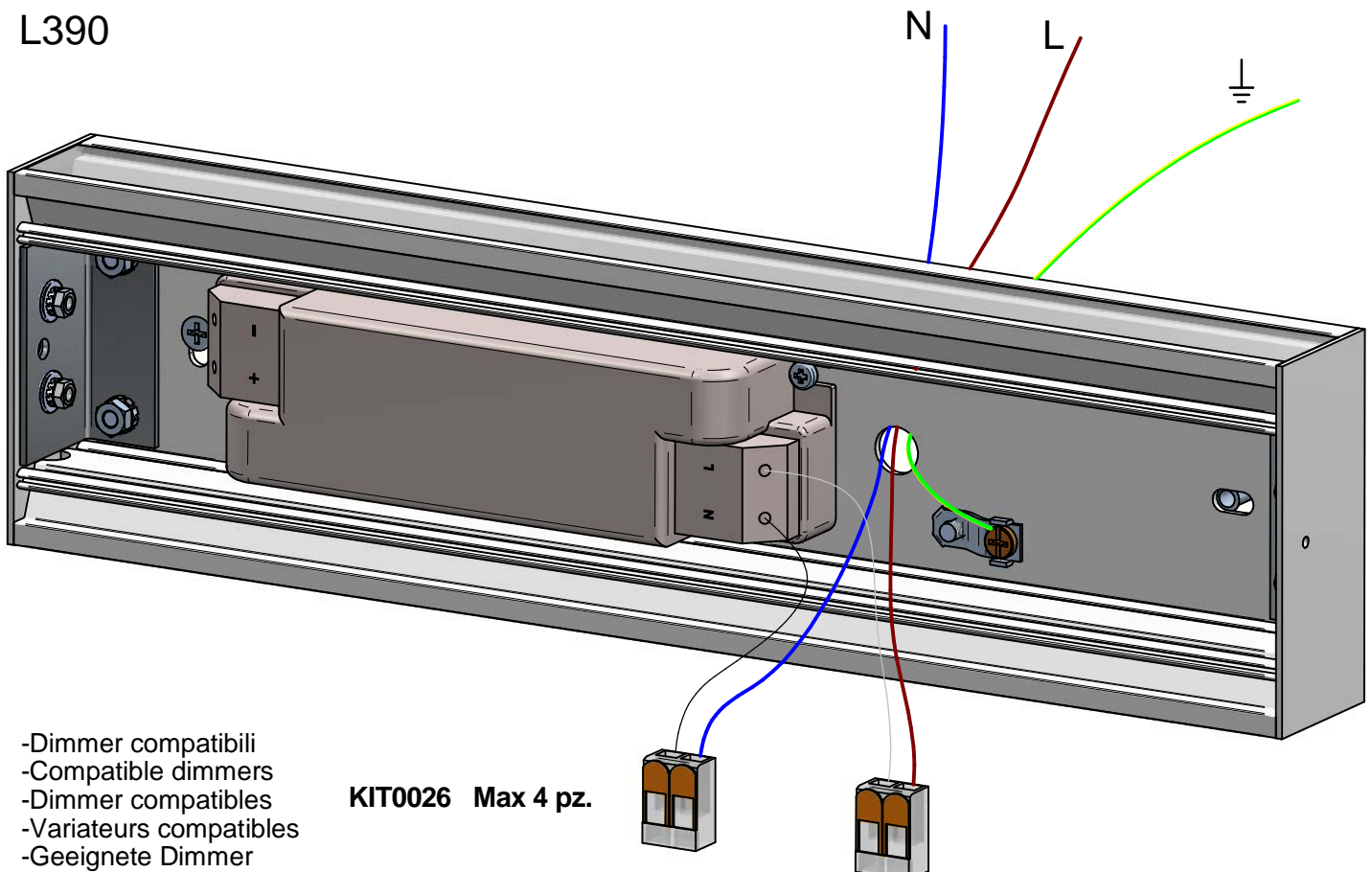

- Dimmer compatibili
- Compatible dimmers
- Dimmer compatibles
- Variateurs compatibles
- Geeignete Dimmer

**KIT0026** Max 4 pz.

L390

### KIT0080 - CASAMBI

unità controllo wireless  
wireless control unit

KIT non incluso;  
Può essere posizionato internamente all'articolo;  
utilizzabile per 1 - 2 articoli.

KIT not included;  
It can be placed inside the article;  
usable for 1 - 2 items.

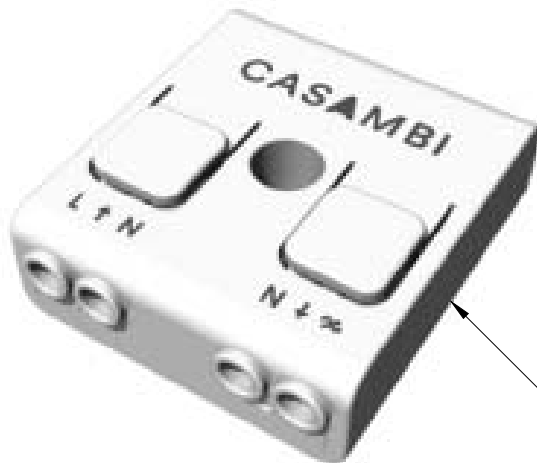

Cavi inclusi in KIT0080  
Cables included in KIT0080

## CABLAGGIO - WIRING

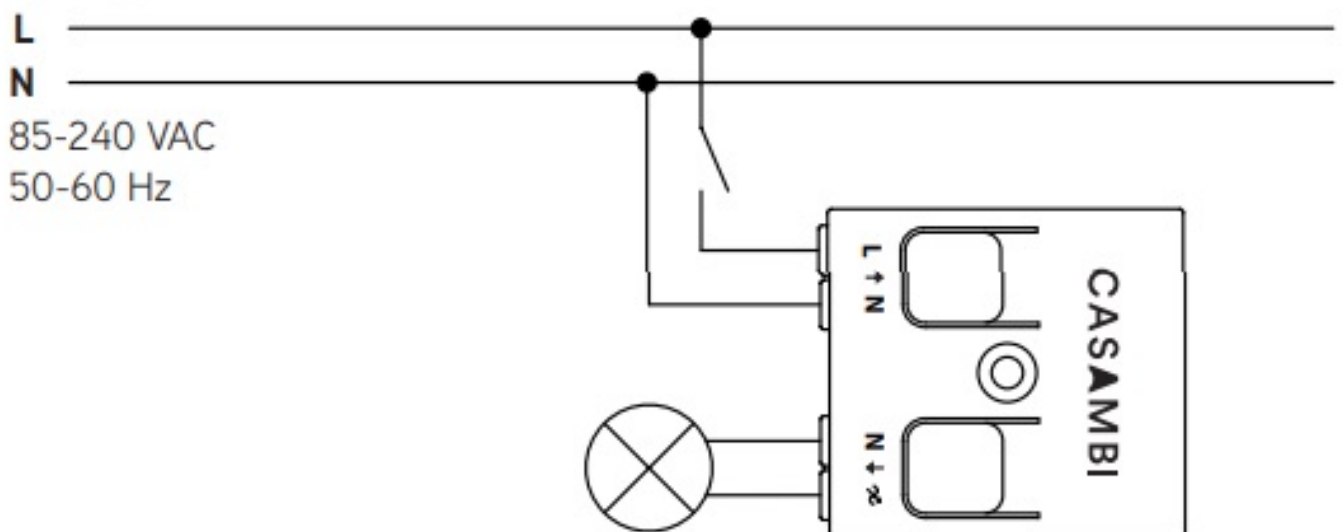

4  
L260

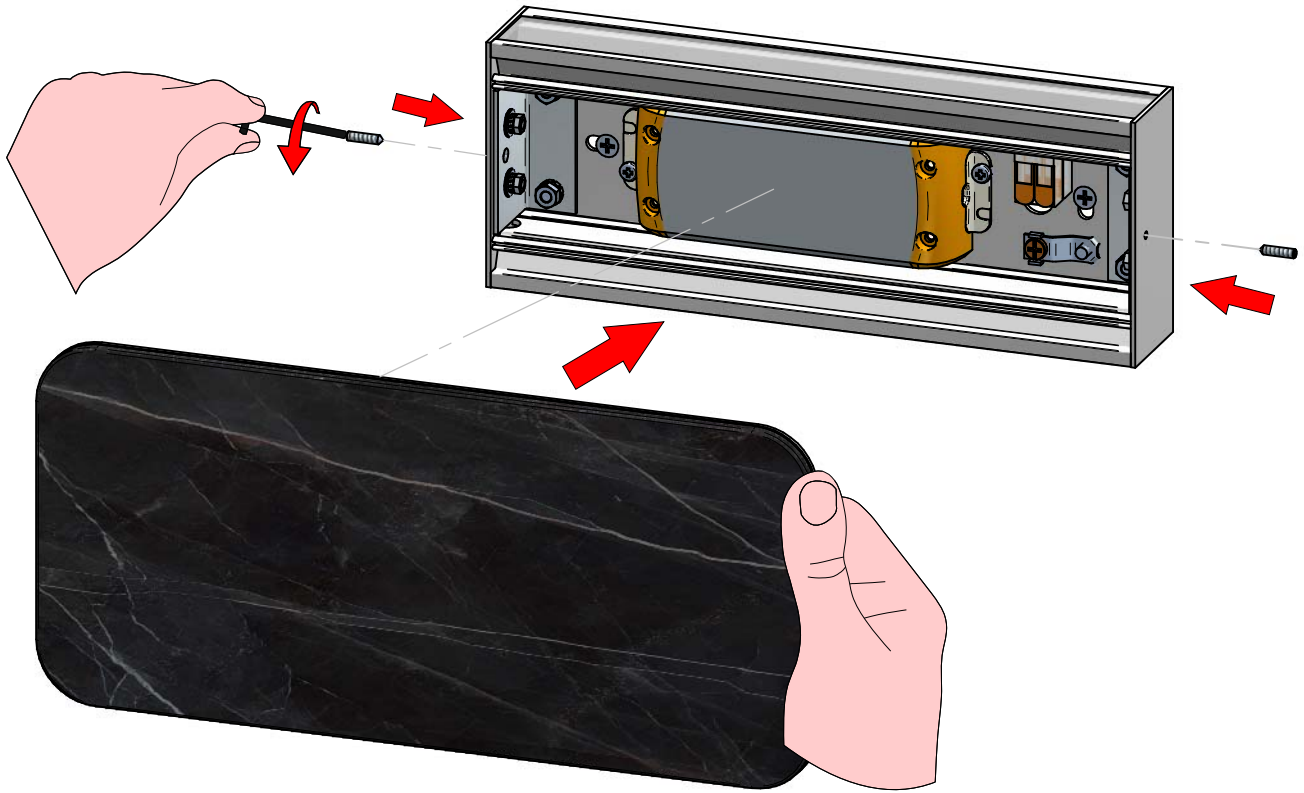

L390

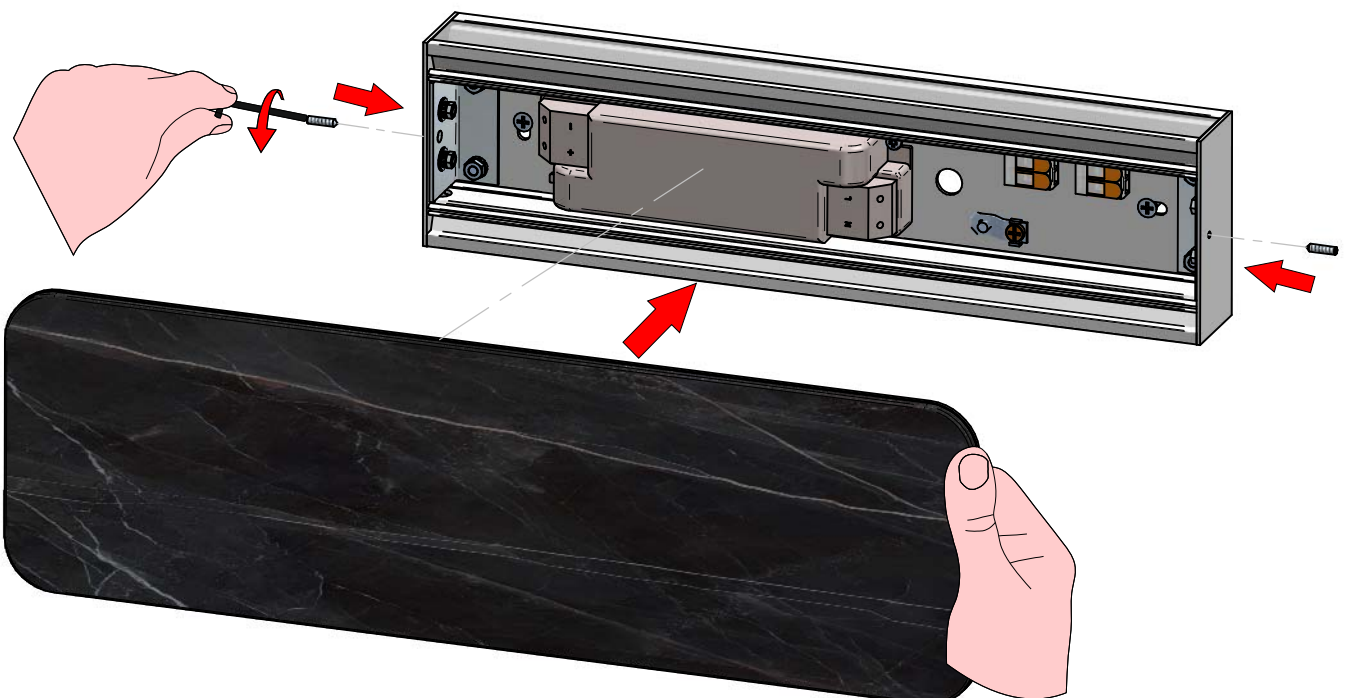



**ISTRUZIONI PER IL LAVAGGIO DELL'APPARECCHIO D'ILLUMINAZIONE**  
**LUMINAIRE CARE INSTRUCTIONS**  
**ISTRUCCIONES PARA LIMPIAR LA LUMINARA**  
**INSTRUCTIONS POUR LE LAVAGE DE L'APPAREIL D'ECLAIRAGE**  
**ANLEITUNG ZUR REINIGUNG DES BELEUCHTUNGSGERATS**

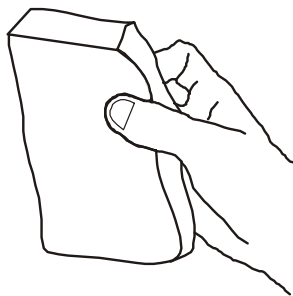
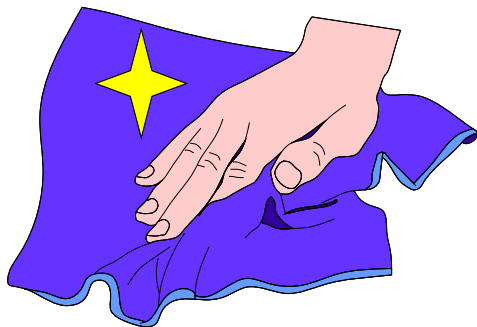

**IT - ATTENZIONE!!!**

Lavare la superficie del diffusore luce con panno umido, utilizzando solo acqua e sapone neutro.

**EN - WARNING!!!**

Wipe clean with a cloth dampened in water with neutral detergent.

**ES - ATENCION!!!**

Limpie la superficie del difusor con un pano humedecido con agua y jabon neutro.

**FR - ATTENTION!!!**

Laver la surface du diffuseur de lumiere a l'aide d'un chiffon humide et en utilisant seulement de l'eau et du savon neutre.

**DE - ACHTUNG!!!**

Die oberfläche vom lampenschirm mit einem feuchten lappen reinigen. De lappen mit wasser und neutralseife befeuchten.

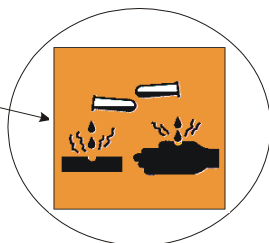
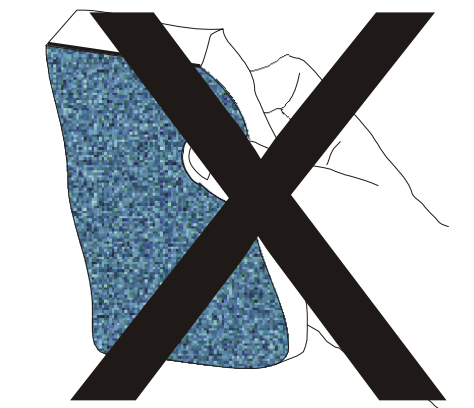

**IT - ATTENZIONE!!!**

Non utilizzare panni abrasivi e/o solventi.

**EN - WARNING!!!**

Avoiding the use of chemical solvents and/or abrasive cloths.

**ES - ATENCION!!!**

No utilizar panos abrasivos y solventes.

**FR - ATTENTION!!!**

Ne pas utiliser de chiffons abrasifs ou de dissolvants.

**DE - ACHTUNG!!!**

Abschleifende tuche und/oder losungsmittel nicht benutzen.