

Ribbon 70 led/m

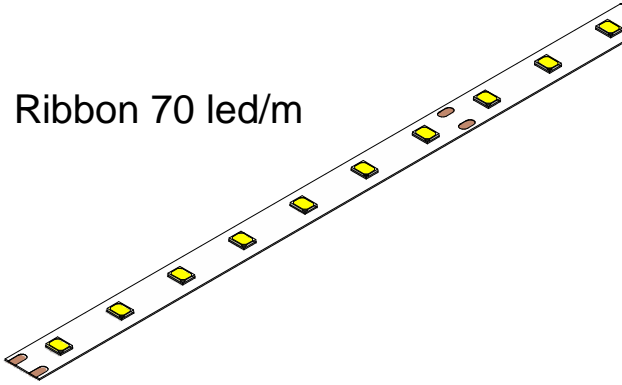

Ribbon 140 led/m

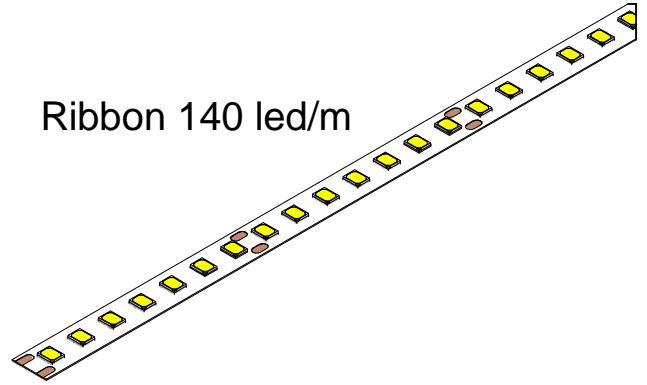

Ribbon RGBW

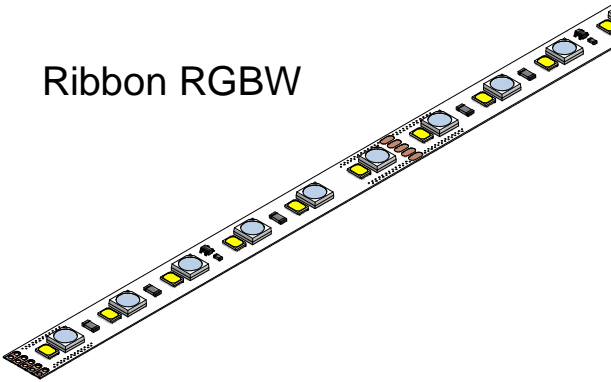

Ribbon Dynamic White

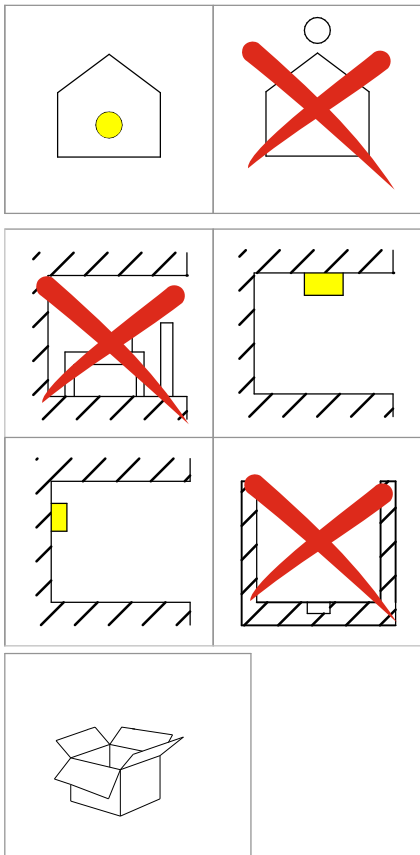
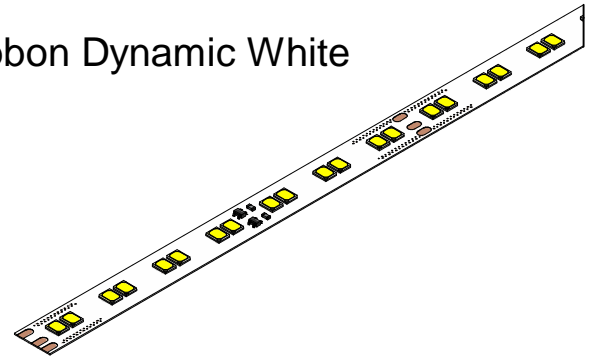

Ribbon Plus	
82174	Ribbon Plus BA
82175	Ribbon Plus BA
82176	Ribbon Plus BA
82180	Ribbon Plus HF
82181	Ribbon Plus HF
82182	Ribbon Plus HF
82186	Ribbon Plus BA
82187	Ribbon Plus BA
82188	Ribbon Plus BA
82192	Ribbon Plus HF
82193	Ribbon Plus HF
82194	Ribbon Plus HF
82207	Ribbon Plus HF
82209	Ribbon Plus HF
82210	Ribbon Plus HF
C00417WHVDI	Ribbon RGBW
C00418WHDDI	Ribbon Dynamic White
C00419WHSDI	Ribbon Warm Tune

1

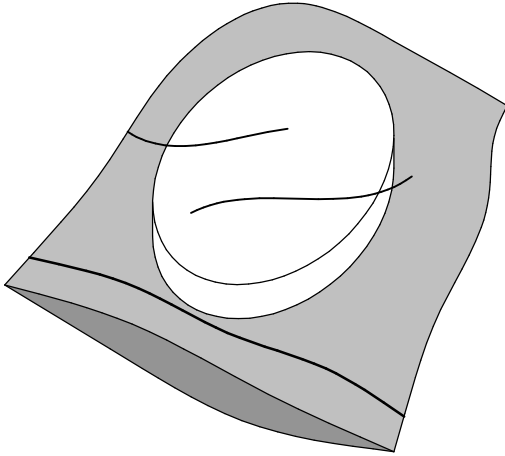

2

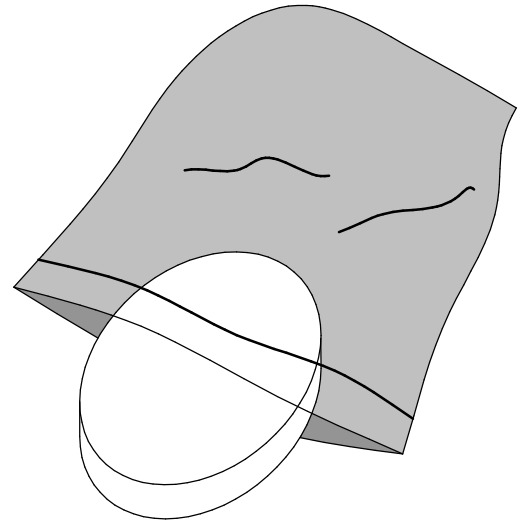

3

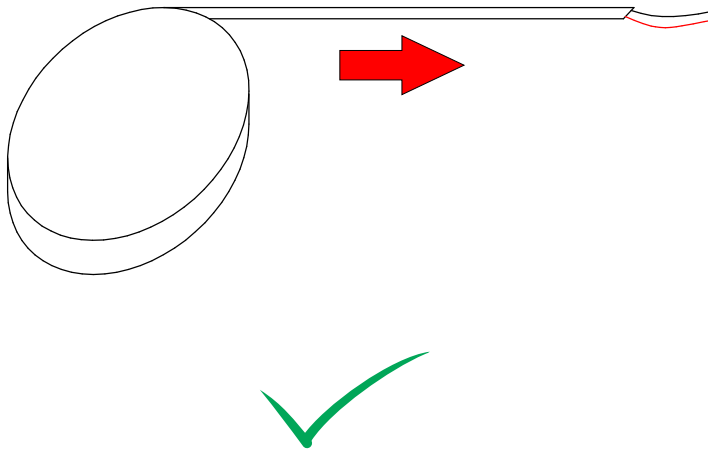

4

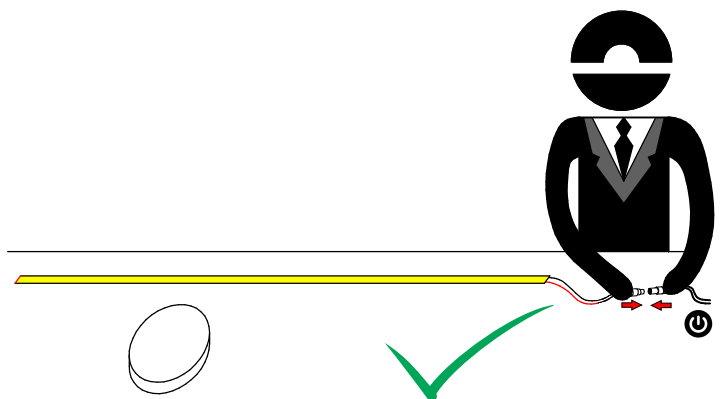
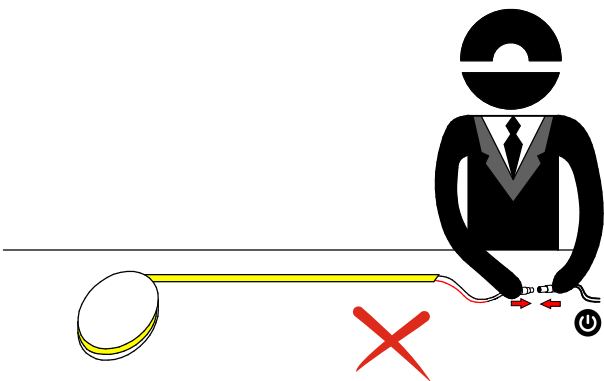
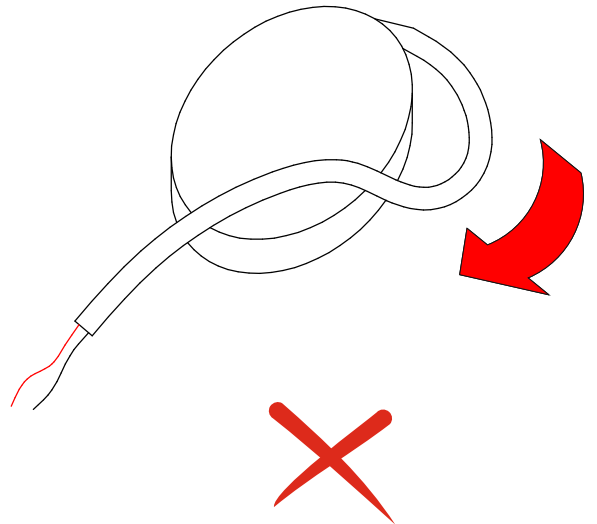

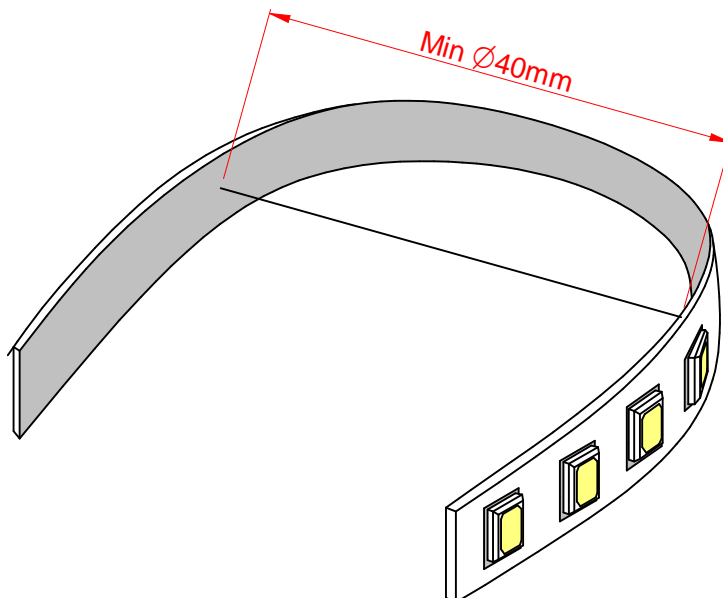
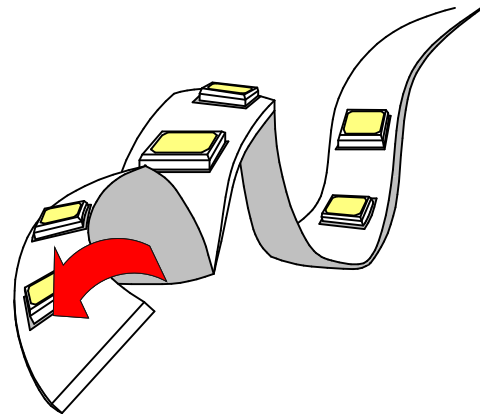
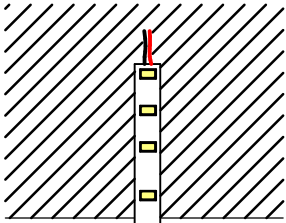

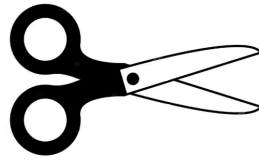

Ribbon Plus 70 led/m

Tc point $\leq 70\text{ }^{\circ}\text{C}$

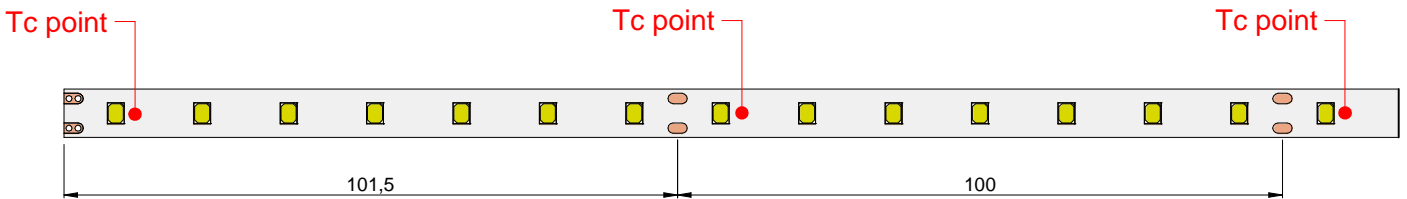

Ribbon Plus 140 led/m

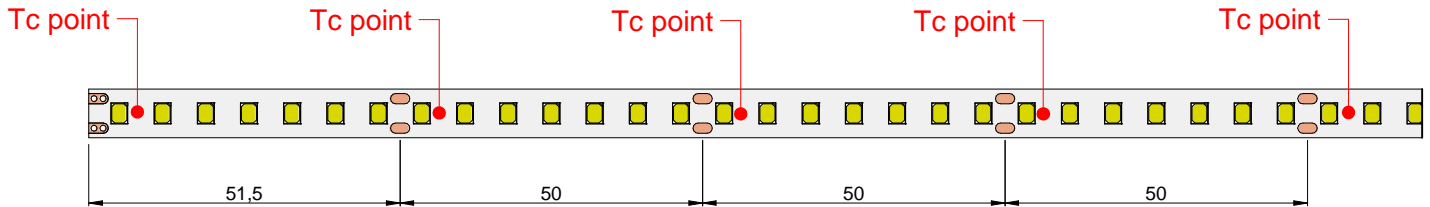

Ribbon Plus RGBW

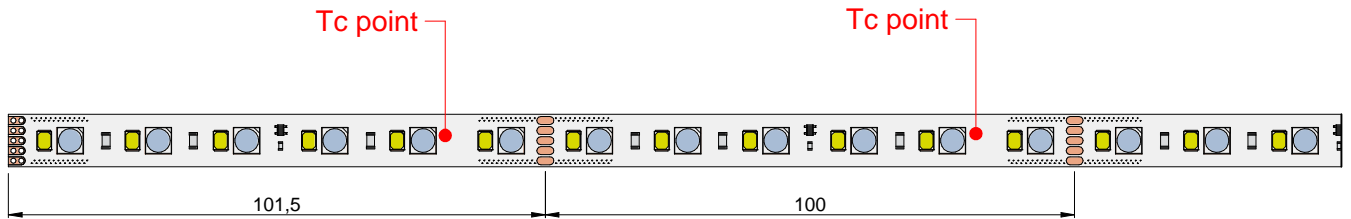

Ribbon Plus Dynamic white

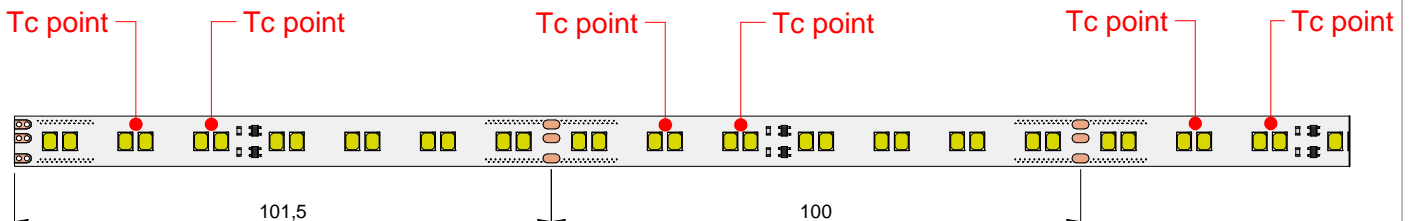

Ribbon Plus WT

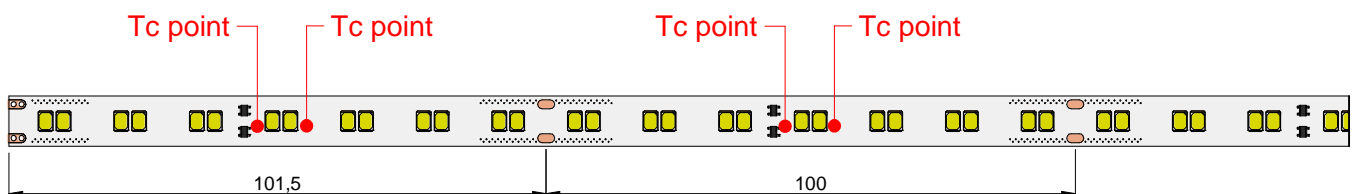

BASIC / HIGH-FLUX RIBBON

	Xmm	L1 m	L2 m	Code
	0,75	20	10	82174-82175-82176
	1,5	25	10	82174-82175-82176
	2,5	30	10	82174-82175-82176
	4	30	12	82174-82175-82176

	Xmm	L1 m	L2 m	Code
	0,75	15	6	82180-82181-82182
	1,5	25	5	82180-82181-82182
	2,5	30	5	82180-82181-82182
	4	20	9	82180-82181-82182

	Xmm	L1 m	L2 m	Code
	0,75	10	9	82186-82187-82188
	1,5	10	10	82186-82187-82188
	2,5	10	10	82186-82187-82188
	4	30	10	82186-82187-82188

	Xmm	L1 m	L2 m	Code
	0,75	10	5	82192-82193-82194
	1,5	15	5	82192-82193-82194
	2,5	30	5	82192-82193-82194

	Xmm	L1 m	L2 m	Code
	0,75	5	5	82207-82209-82210
	1,5	5	5	82207-82209-82210
	2,5	10	5	82207-82209-82210
	4	15	5	82207-82209-82210

$$L2 = L3 + L4$$

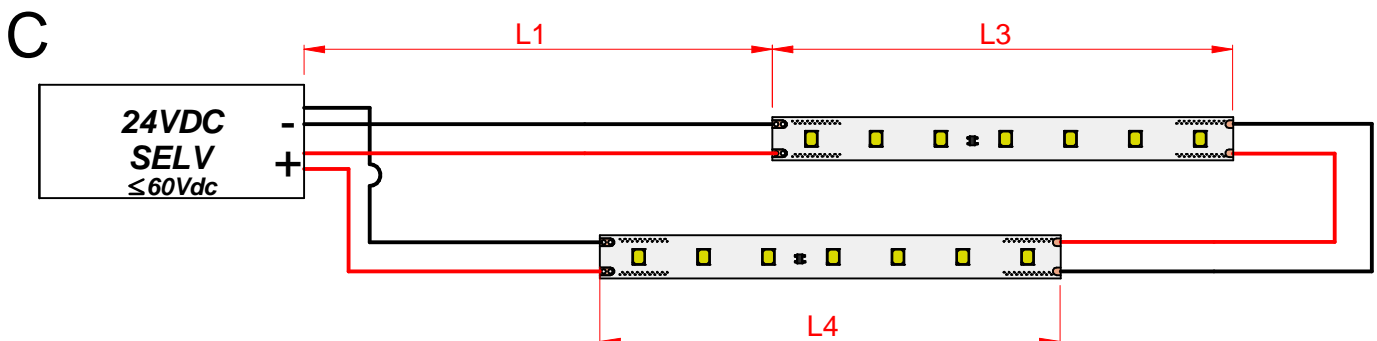
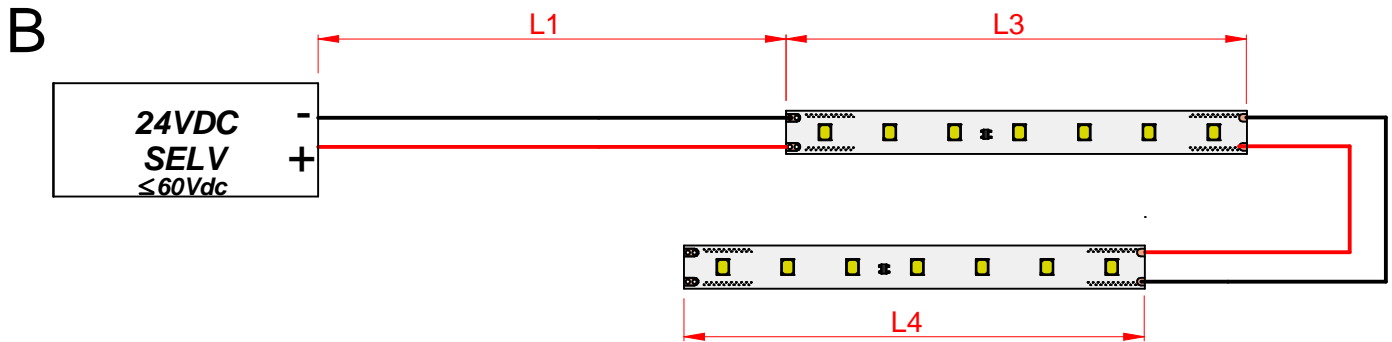
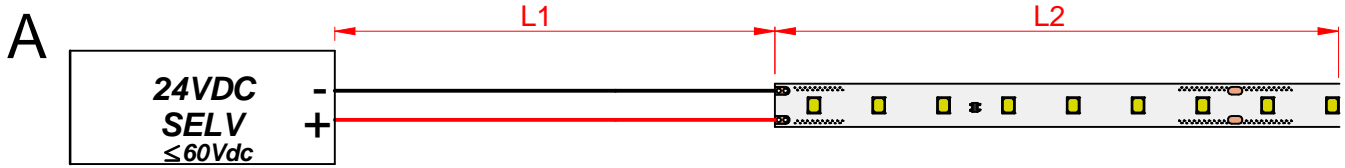

DYNAMIC WHITE RIBBON

	Xmm	L1 m	L2 m	Code
	1,5	X	5	C00418WHDDI
	2,5	X	5	C00418WHDDI

A

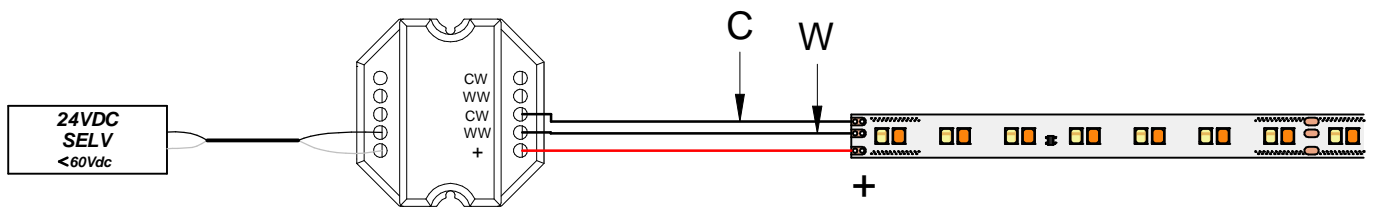

B

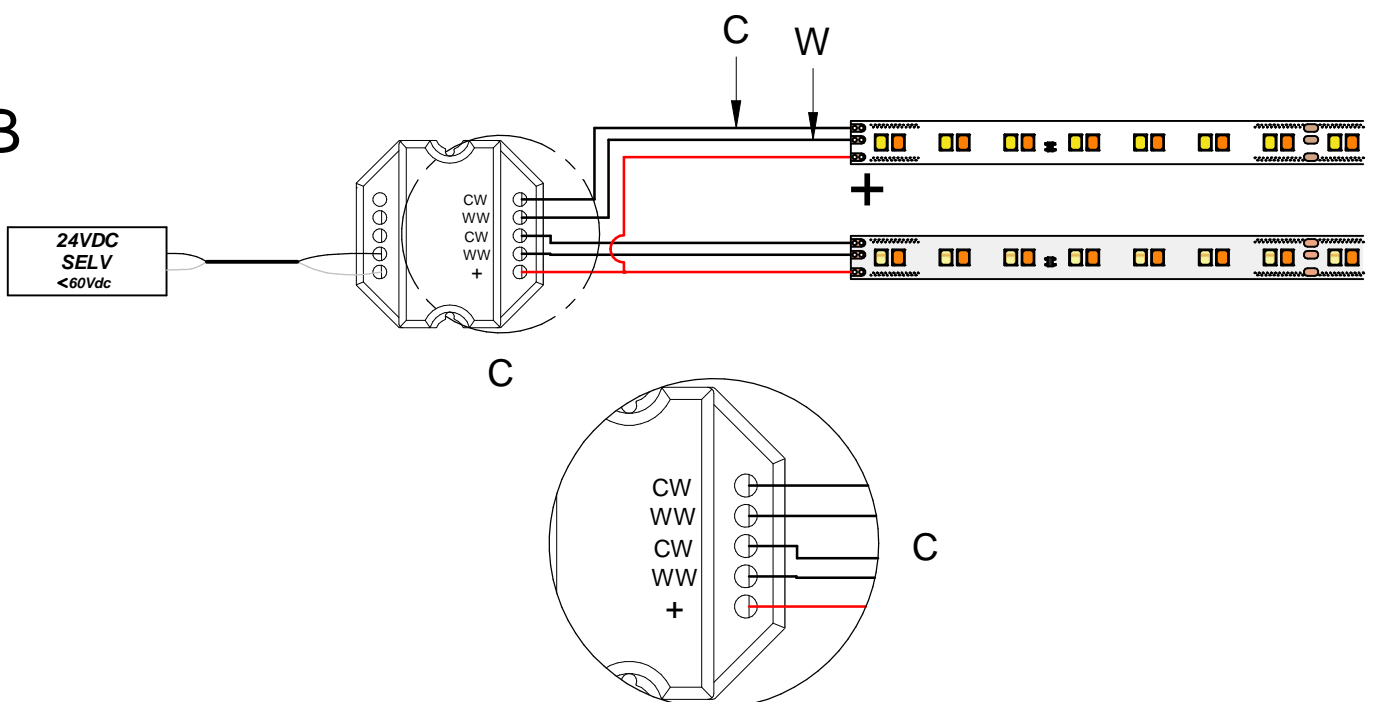

WARM TUNE RIBBON

	Xmm	L1 m (MAX)	L2 m	Code
	1,5	5	5	C00419WHSDI
	2,5	10	5	C00419WHSDI

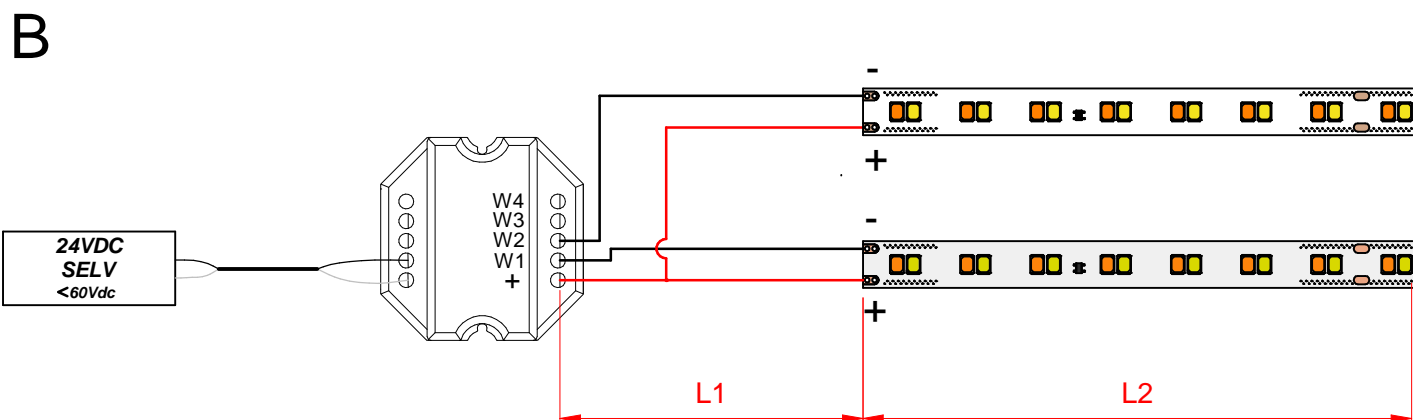
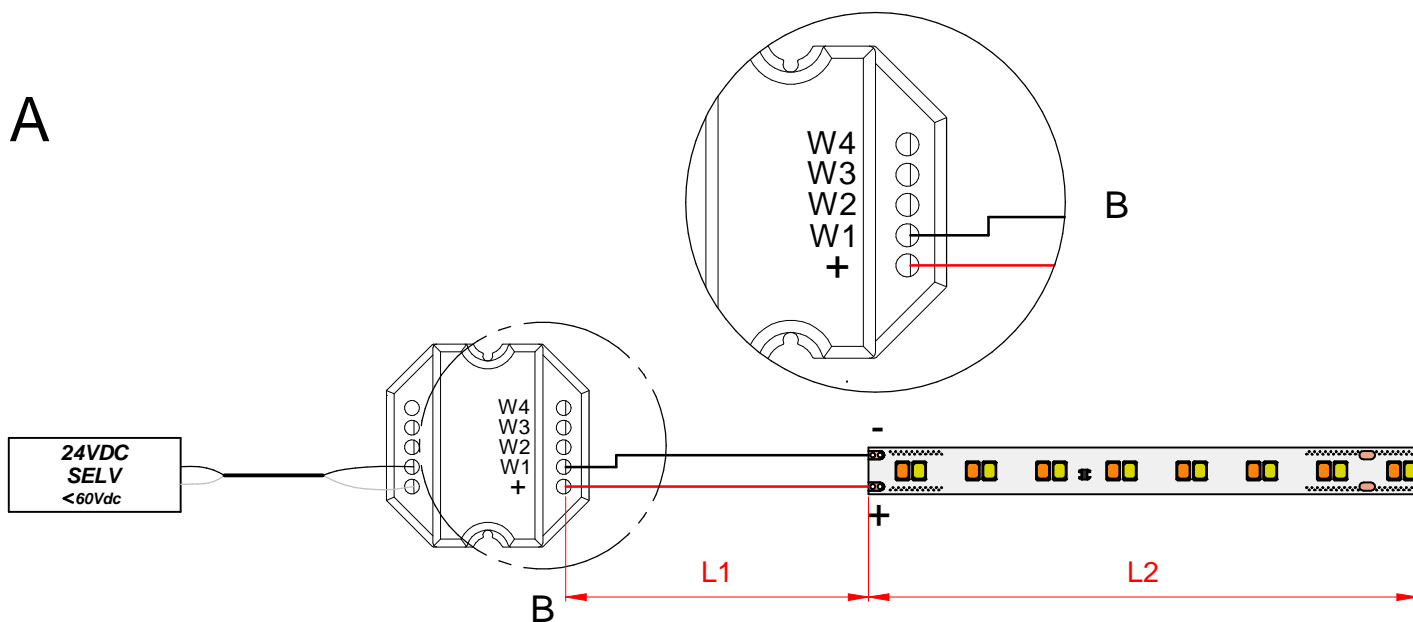

RGBW RIBBON

	Xmm	L1 m	L2 m	Code
	1,5	X	5	C00417WHVDI
	2,5	X	5	C00417WHVDI

A

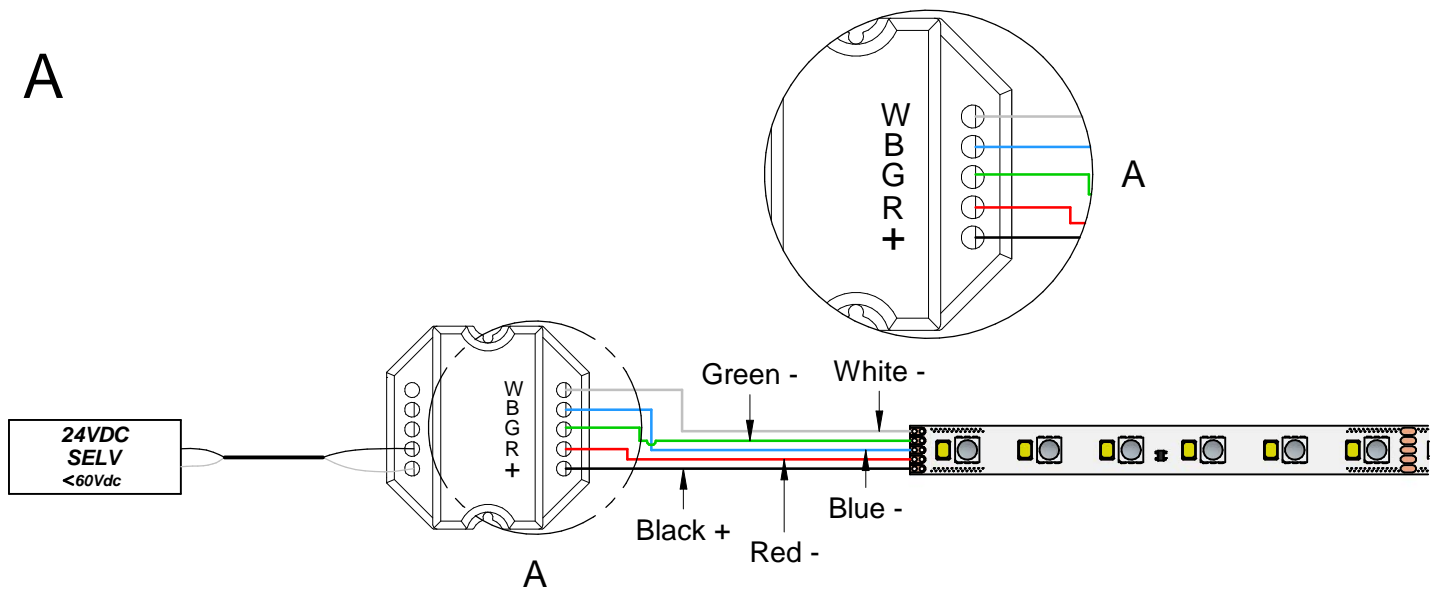

B

