

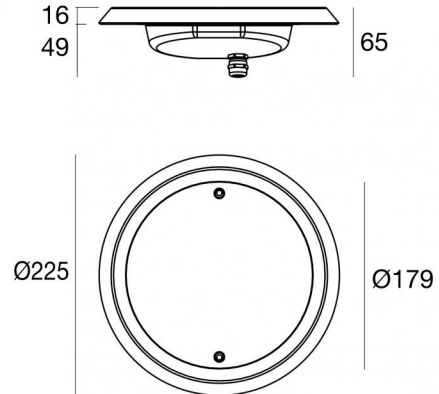

Immersion | 9 x powerLEDs 38 W DC 700 mA
 RGBW - 3000
84044V40



Données techniques	
Typologie	Frame
Position d'installation	Mur - Sol
Environnement d'installation	Extérieur
Source lumineuse	LED
Circuit structure	powerLEDs
Optique	Medium Wide Flood
Light emission direction	frontal
Puissance nominale	38 W DC
Plage de tension d'entrée	700mA
Température de couleur / Tone	RGBW - 3000 K
C.C. / V.C.	CC
Classe d'isolation	3
IP	IP68
Profondeur d'installation maximale	25 m
Limitation de l'installation	Seulement sous l'eau
IK	IK10
Essai au fil incandescent	850°
Montage direct sur des surfaces normalement inflammables	Oui
CE	Oui
Driver inclus	Non
Article à intensité variable	Oui
Orientable	Non
Basculement	Non
Piétinable	Non
Carrossable	Non
Câble inclus	Oui
Longueur du câble	5 m
Revêtement en résine	Oui
Type d'émission lumineuse	Émission simple
Poids net	0.8 Kg
Protection contre les décharges électrostatiques	Non
Protection contre les surtensions	Non
Caractéristiques technologiques du produit	Acquastop

Finition corps

Matériau	Acier AISI 316L
Couleur	acier



Finition diffuseur

Matériau	Verre extra clair - trempé
Couleur	transparent
Fabrication	Séigraphie

Finition bride

Matériau	Acier inoxydable 316
Couleur	acier
Fabrication	électropolissage

Électronique

- 
83010
 On/Off Driver 90~264V AC / 127~370V DC 60 W (1 art.)
- 
83187
 Push and Simply Dim - DMX-RDM Multi Channel 4ch. 10.8~52.8V DC (1 art.)

Lumen RGBW

N. Led	Rouge	Vert	Bleu	blanc
9	261 lm	675 lm	216 lm	729 lm



Immersion | 9 x powerLEDs 38 W DC 700 mA | RGBW - 3000
84044V40

Single emission submerged for outdoor application. The RGBW - 3000 K LED light source with a medium wide flood light distribution is composed of 9 powered LEDs with CCT of RGB-W 3000 K.

The device body is made of aisi 316l steel and features a steel finish; the diffuser is made of extra clear glass - tempered with a silk-screening treatment. The ingress protection degree is IP68; the total weight is of 0.8 kg. The power supply driver is not provided and is to be ordered separately.

The total absorbed power is 38 W. The power supply cable is included and features a 5 m length.

The device features protection class III and can be wall lights or floor-mounted with an outer casing, code 83198(for concrete or masonry).

Compliant with the EN 60598-1 standard and its specific provisions.

Température standard de l'environnement de	-20 / +50°C
Température typique sur le verre	40°C

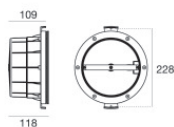

Boîtier d'encastrement - Boîtier extérieur pour installation sur toile
position d'installation: mur; type installation: maçonnerie L=213mm, H=213mm, D=110mm.
Matériau:Plastique ABS, couleur:noir.

Code
83198

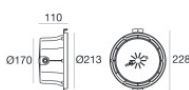
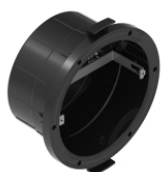

Boîtier d'encastrement - Caisson IP68 pour installation sur maçonnerie (carrelage ou mosaïque)
position d'installation: mur; type installation: maçonnerie L=213mm, H=213mm, D=110mm.
Matériau:Plastique ABS, couleur:noir.

Code
83142

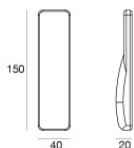

Remote RF

Code
C-W600001

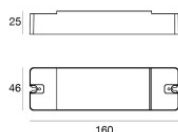

Variateur
RF Remote controller

Code
C-E700003