

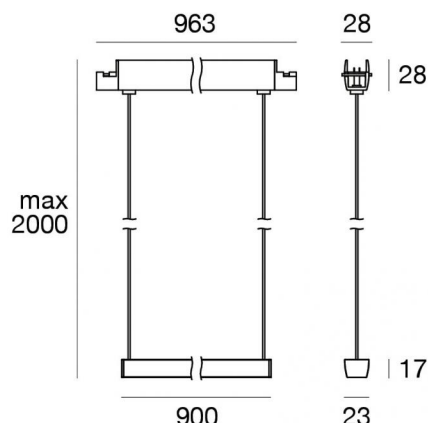

Systèmes - Éléments linéaires
54 topLED 9 W DC 24 V | CRI 90

83963W30



Données techniques	
Designer	Linea Light
Année de réalisation	2020
Typologie	Systèmes - Éléments linéaires
Position d'installation	Câble
Environnement d'installation	Intérieur
Source lumineuse	LED
Circuit structure	topLED
Optique	Medium Flood
Light emission direction	downward
Puissance nominale	9 W DC
Flux lumineux (source)	781 lm
Frequency	50-60 Hz
Température de couleur / Tone	3000 K
Indice de rendu chromatique	90 Ra
C.C. / V.C.	CV
Classe d'isolation	3
IP	IP40
Essai au fil incandescent	650°
Montage direct sur des surfaces normalement inflammables	Oui
CE	Oui
Driver inclus	Non
Article à intensité variable	DALI - 1-10V - PUSH DIM
Orientable	Non
Basculement	Non
Piétinable	Non
Carrossable	Non
Câble inclus	Non
Revêtement en résine	Non
Type d'émission lumineuse	Émission simple
Poids net	1 Kg
Protection contre les décharges électrostatiques	Non
Protection contre les surtensions	Non
Technologie optique	Dark light

Finition corps

Matériau	Aluminium
Fabrication	Vernissage

Finition diffuseur

Matériau	PMMA
Couleur	transparent

Finition monture

Matériau	Aluminium
Fabrication	Vernissage

Électronique

 81416
On/Off Driver 220-240V AC 120 W (1 - 13 art.)

 81417
On/Off Driver 220-240V AC 180 W (1 - 20 art.)

 83042
1-10V - Push and Simply Dim - DALI-2 Controller (1 - 32 art.)



Systèmes - Éléments linéaires | 54 topLED 9 W DC 24 V | CRI 90
83963W30

Single emission systems or lines for indoor application. The warm white LED light source with a medium flood light distribution is composed of 54 topped LEDs with CCT of 3000 K and a CRI 90; the source luminous flux is 781 lm, with a 86.8 lm/W nominal luminous efficacy.

The device body is made of aluminium and features a 5g 9005 black finish, processed by means of coating; the diffuser is made of pmma; the mounting frame is made of aluminium, with a 5g 9005 black finish, processed by means of coating. The ingress protection degree is IP40; the total weight is of 1 kg. The power supply driver is not provided and is to be ordered separately.

The total absorbed power is 9 W.

The device features protection class III and can be cable-mounted.

Compliant with the EN 60598-1 standard and its specific provisions.

Classe d'efficacité énergétique

Ce produit contient 2 sources lumineuses de classe d'efficacité énergétique F.

Caractéristiques Techniques de l'éclairage

Light Output Ratio (LOR)	35 %
Flux lumineux (source)	781 lm
Flux lumineux du luminaire	275 lm
Consumption	9 W
Efficacité lumineuse du luminaire	30 lm/W
Température de couleur	3000 K
Standards de Concordance de Couleur	3 Step MacAdam
Indice de rendu chromatique	90 Ra
Température de jonction (appareil)	80

Température standard de l'environnement de -20 / +50°C

LED Life / Failure Ratio

L70 B20 C0 72500h (at Tj 115 Ta 25)

UGR

UGR axial	-4.3
UGR transversal	11.6
X=4H Y=8H	S=0.25H
Reflection factor	70/50/20

OPTICAL

Optique C90/C270	34°
Optique C0/C180	58°
Light distribution simmetry	Symmetrical 2 assis

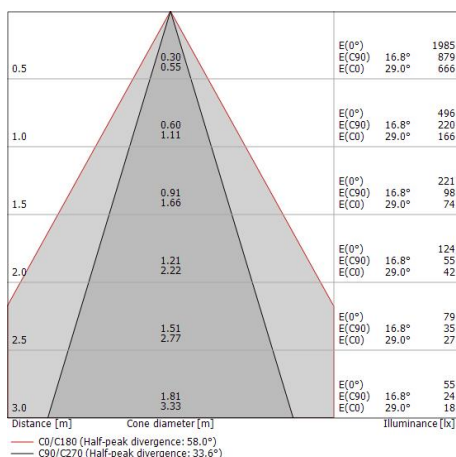
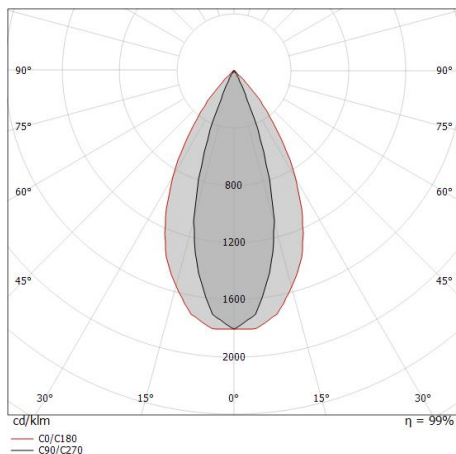



		<p>Câble Type câble power cable; Longueur 5000 mm; isolation doppio; section 1.5 mm²; serre-câble: non; couleurs: noir - rouge.</p>	<p>Code <u>81410</u></p>
		<p>Outil - Kit de coupe/dénudage de câbles</p>	<p>Code <u>81427</u></p>
		<p>Câble Type câble power cable; Longueur 1000 mm; isolation doppio; section 1.5 mm²; serre-câble: non; couleurs: noir - rouge.</p>	<p>Code <u>84016</u></p>
		<p>Câble Type câble power cable; Longueur 10000 mm; isolation doppio; section 1.5 mm²; serre-câble: non; couleurs: noir - rouge.</p>	<p>Code <u>81411</u></p>
		<p>Profil - L. 1000mm Matériau:Aluminium, fabrication :Vernissage.</p>	<p>Code <u>84012</u></p>
		<p>Profil - L. 2000mm Matériau:Aluminium, fabrication :Vernissage.</p>	<p>Code <u>84013</u></p>
		<p>Profil - L. 3000mm Matériau:Aluminium, fabrication :Vernissage.</p>	<p>Code <u>84014</u></p>
		<p>Profil - Coin intégré Matériau:Aluminium, fabrication :Vernissage.</p>	<p>Code <u>84015</u></p>



Ink system_LP UGR | Lines | Accessories
83963W30

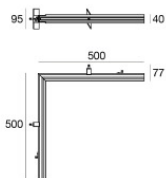

Profil - Coin intégré - IN
Matériau:Aluminium, fabrication :Vernissage.

Code
84073

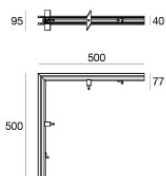
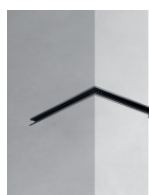

Profil - Coin intégré - OUT
Matériau:Aluminium, fabrication :Vernissage.

Code
84074

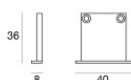

Bouchon - 2X
Matériau:PC, couleur:noir.

Code
83153

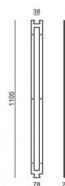

Gabarit

Code
83186