

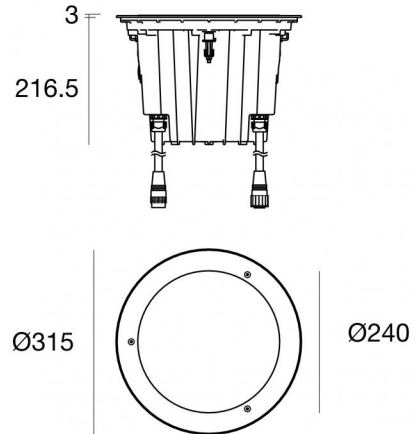

Uplights | 198-264 V AC /180-275 V DC
1 arrayLED 37 W DC - 41 W AC | RGBW - 3000
83941V15



Données techniques	
Typologie	Carrossable
Position d'installation	Sol
Environnement d'installation	Extérieur
Source lumineuse	LED
Circuit structure	arrayLED
Optique	Spot
Light emission direction	upward
Puissance nominale	37 W DC
Pouvoir total	41 W
Tension d'entrée nominale	220 - 240 V AC
Plage de tension d'entrée	198 - 264 V AC
Frequency	50 - 60 Hz
Température de couleur / Tone	RGBW - 3000 K
C.C. / V.C.	AC
Classe d'isolation	1
IP	IP68
Limitation de l'installation	Ne pas utiliser sous l'eau
IK	IK10
Essai au fil incandescent	850°
Montage direct sur des surfaces normalement inflammables	Non
CE	Oui
Driver inclus	Control unit/Driver
Article à intensité variable	DMX-RDM
Orientable	Non
Basculement	Non
Piétinable	Oui
Carrossable	5000 Kg
Câble inclus	Oui
Longueur du câble	0.2 m
Revêtement en résine	Oui
Type d'émission lumineuse	Émission simple
Poids net	8 Kg
Protection contre les décharges électrostatiques	Oui
Protection contre les surtensions	Oui
Caractéristiques technologiques du produit	Acquastop

Finition corps

Matériau	Aluminium moulé sous pression EN AB - 46100
Couleur	noir
Fabrication	Anodisation à pores ouverts + revêtement par poudre

Finition diffuseur

Matériau	Verre extra clair - trempé
Couleur	transparent
Fabrication	Séigraphie

Finition bride

Matériau	Acier AISI 316
Couleur	acier
Fabrication	Brossage

Câbles Electrification+signal

Cable connector AllinONE Male Plug 6 Pin

IP (locked condition) 67

Cable connector ALLinONE Female Socket 6 Pin

Lumen RGBW

N. Led	Rouge	Vert	Bleu	blanc
1	438 lm	894 lm	318 lm	1206 lm

L'alimentation électrique contenue dans l'appareil est conforme à la norme CEI 61347-2-13 annexe J et peut donc être alimentée par des systèmes d'alimentation centralisés.



Uplights | 198-264 V AC /180-275 V DC | 1 arrayLED 37 W DC - 41 W AC | RGBW - 3000
83941V15

Single emission uplights for outdoor application. The RGBW - 3000 K LED light source with a spot light distribution is composed of 1 arrayled LEDs with CCT of RGB-W 3000 K.

The device body is made of die-cast aluminium en ab - 46100 and features a black finish, processed by means of open pore anodizing + powder coating; the diffuser is made of extra clear glass - tempered with a silk-screening treatment. The ingress protection degree is IP68; the total weight is of 8 kg.









The total absorbed power is 37 W. The power supply cable is included and features a 0.2 m length.

The device features protection class I and can be floor-mounted with an outer casing, code 83096(for concrete or masonry).

Compliant with the EN 60598-1 standard and its specific provisions.

Température standard de l'environnement de	-20 / +50°C
Température typique sur le verre	65°C

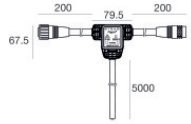

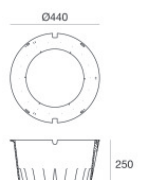
<p>L. 1m</p> 	<p>Câble et connecteur Type câble power + signal cable allinone; Longueur 1000 mm; isolation doppio con schermatura per segnale; diamètre externe: 12.6 mm; couleurs: blanc - bleu - rouge - gris - brun - jaune-vert.</p>	<p>Code <u>98660</u></p>
<p>L. 5m</p> 	<p>Câble et connecteur Type câble power + signal cable allinone; Longueur 5000 mm; isolation doppio con schermatura per segnale; diamètre externe: 12.6 mm; couleurs: blanc - bleu - rouge - gris - brun - jaune-vert.</p>	<p>Code <u>98661</u></p>
<p>L. 1m</p> 	<p>Câble et connecteur Type câble power + signal cable allinone; Longueur 1000 mm; isolation doppio con schermatura per segnale; diamètre externe: 12.6 mm.</p>	<p>Code <u>98662</u></p>
<p>L. 5m</p> 	<p>Câble et connecteur Type câble power + signal cable allinone; Longueur 5000 mm; isolation doppio con schermatura per segnale; diamètre externe: 12.6 mm.</p>	<p>Code <u>98663</u></p>
 	<p>Connecteur - Start splitter Type câble power + signal cable allinone; Longueur 5000 + 5000 + 200 mm; isolation doppio con schermatura per segnale.</p>	<p>Code <u>98985</u></p>
 	<p>Connecteur - Continuity splitter Type câble power + signal cable allinone; Longueur 200 + 200 + 5000 mm; isolation doppio con schermatura per segnale.</p>	<p>Code <u>99390</u></p>
	<p>Connecteur - Adaptateur de fermeture de ligne DMX pour câbles ALLinONE Type câble power + signal cable allinone; ; isolation doppio con schermatura per segnale.</p>	<p>Code <u>98986</u></p>
 	<p>Boîtier d'encastrement position d'installation: sol; type installation: maçonnerie L=440mm, H=250mm, D=440mm. Matériau:Plastique ABS, couleur:noir.</p>	<p>Code <u>83096</u></p>



Suelo_RX | Uplights | Accessories
83941V15



Gabarit

Code
83097



Accessoires pour boîtiers extérieurs - Fond du boîtier extérieur
Matériau:Fer Zingué, couleur:gris, fabrication :Zingage.

Code
93099