

Tour_Projectors

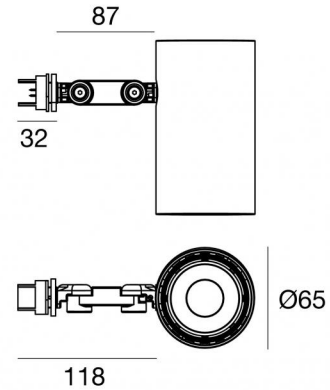

Projecteurs | 1 arrayLED 15 W DC 420 mA | CRI 90
82758M30



Données techniques	
Typologie	Surface
Position d'installation	Plafond
Environnement d'installation	Intérieur
Source lumineuse	LED
Circuit structure	arrayLED
Optique	Medium Flood
Light emission direction	frontal
Puissance nominale	15 W DC
Flux lumineux (source)	2214 lm
Température de couleur / Tone	2700 K
Indice de rendu chromatique	90 Ra
C.C. / V.C.	DC
Classe d'isolation	2
IP	IP20
Essai au fil incandescent	850°
Montage direct sur des surfaces normalement inflammables	Oui
CE	Oui
Article à intensité variable	Non
Orientable	Orientable
angle total (plan vertical)	180 °
angle total (plan horizontal)	360 °
Basculement	Non
Piétinable	Non
Carrossable	Non
Câble inclus	Non
Revêtement en résine	Non
Type d'émission lumineuse	Émission simple
Poids net	0.53 Kg
Protection contre les décharges électrostatiques	Non
Protection contre les surtensions	Non

Finition corps	
Matériau	Aluminium
Couleur	Noir
Fabrication	Vernissage



Projecteurs | 1 arrayLED 15 W DC 420 mA | CRI 90
82758M30

Single emission projectors for indoor application. The super warm white LED light source with a medium flood light distribution is composed of 1 arrayed LEDs with CCT of 2700 K and a CRI 90; the source luminous flux is 2214 lm, with a 147.6 lm/W nominal luminous efficacy.

The device body is made of aluminium and features a black finish, processed by means of coating. The ingress protection degree is IP20; the total weight is of 0.53 kg.

The total absorbed power is 15 W.

The device features protection class II and can be ceiling-mounted.

Compliant with the EN 60598-1 standard and its specific provisions.

Classe d'efficacité énergétique

Ce produit contient une source lumineuse de classe d'efficacité énergétique E.

Caractéristiques Techniques de l'éclairage

Light Output Ratio (LOR)	68 %
Flux lumineux (source)	2214 lm
Flux lumineux du luminaire	1509 lm
Consumption	15 W
Efficacité lumineuse du luminaire	100 lm/W
Température de couleur	2700 K
Standards de Concordance de Couleur	2 Step MacAdam
Indice de rendu chromatique	90 Ra
Colour Rendering Index	60 R9
Black Body Locus	On
Température standard de l'environnement de	-20 / +50°C

LED Life / Failure Ratio

L70 B10 C0 252000h (at Tj 65 Ta 25)

UGR

UGR axial	17.3
UGR transversal	17.2
X=4H Y=8H	S=0.25H
Reflection factor	70/50/20

OPTICAL

Optique C0/C180	35°
Light distribution simmetry	Symmetrical

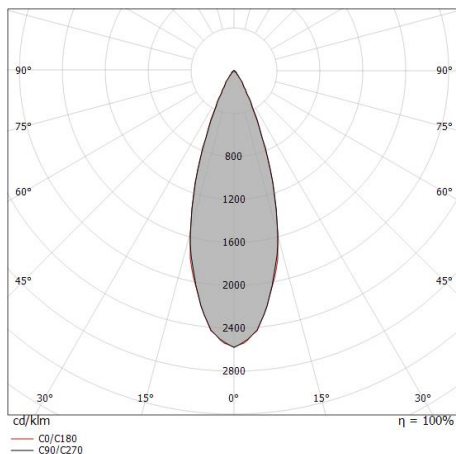

Distance [m]	Cone diameter [m]	Beam diameter [m]	E(0°)	E(C0)	illuminance [lx]
0.5	0.31	0.31	15534	6779	17.4°
1.0	0.63	0.63	3884	1695	17.4°
1.5	0.94	0.94	1726	753	17.4°
2.0	1.25	1.25	971	424	17.4°
2.5	1.57	1.57	621	271	17.4°
3.0	1.88	1.88	432	188	17.4°

Distance [m] Cone diameter [m] illuminance [lx]
 — C0/C180 (Half-peak divergence: 34.8°)





Projecteurs | 1 arrayLED 15 W DC 420 mA | CRI 90
82758M30

Components

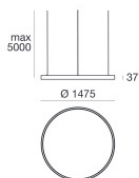









Tour_Track

Code

82753 - 82756 - 82755 - 82754



	<p>Diffuseur Type de diffuseur: filtro ellittico. Matériau:Pom-C, couleur:Noir.</p>	<p>Code <u>99781</u></p>
	<p>anti-éblouissement Type anti-éblouissement: grille en nid d'abeille. Matériau:Pom-C, couleur:Noir.</p>	<p>Code <u>99780</u></p>
	<p>anti-éblouissement Type anti-éblouissement: frangiluca a croce. Matériau:Pom-C, couleur:Noir.</p>	<p>Code <u>99779</u></p>
	<p>anti-éblouissement Type anti-éblouissement: schermo cilindrico. Matériau:Pom-C, couleur:Noir.</p>	<p>Code <u>99783</u></p>
	<p>anti-éblouissement Type anti-éblouissement: schermo cilindrico 45°. Matériau:Pom-C, couleur:Noir.</p>	<p>Code <u>99782</u></p>
	<p>Optique Distribution de la lumière: spot,Matériau revêtement: polycarbonate résistant aux uv</p>	<p>Code <u>99827</u></p>
	<p>Optique Distribution de la lumière: medium flood,Matériau revêtement: ,polycarbonate résistant aux uv,polycarbonate résistant aux uv,polycarbonate résistant aux uv</p>	<p>Code <u>99828</u></p>
	<p>Optique Distribution de la lumière: flood,Matériau revêtement: ,polycarbonate résistant aux uv,polycarbonate résistant aux uv,polycarbonate résistant aux uv</p>	<p>Code <u>99829</u></p>