

Cob40_R

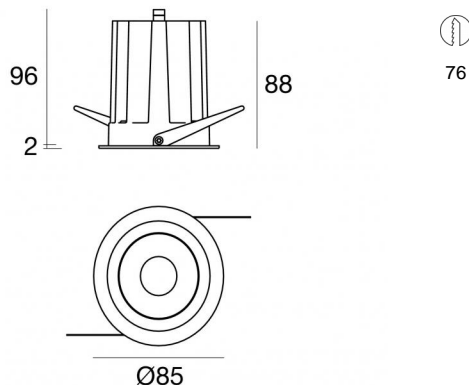

Downlights | 1 arrayLED 18 W DC 500 mA | CRI 90
82474W15



Données techniques

Position d'installation	Plafond
Environnement d'installation	Intérieur
Source lumineuse	LED
Circuit structure	arrayLED
Optique	Spot
Light emission direction	downward
Puissance nominale	18 W DC
Flux lumineux (source)	2818 lm
Plage de tension d'entrée	500mA
Température de couleur / Tone	3000 K
Indice de rendu chromatique	90 Ra
C.C. / V.C.	CC
Classe d'isolation	3
IP	IP40
IP bloc optique	IP44
IK	IK05
Essai au fil incandescent	850°
Montage direct sur des surfaces normalement inflammables	Oui
CE	Oui
Driver inclus	Non
Article à intensité variable	DALI - 1-10V
Orientable	Non
Basculement	Non
Piétinable	Non
Carrossable	Non
Câble inclus	Oui
Longueur du câble	0.15 m
Revêtement en résine	Non
Type d'émission lumineuse	Émission simple
Poids net	0.375 Kg
Protection contre les décharges électrostatiques	Non
Protection contre les surtensions	Non

Finition corps

Matériau	Aluminium moulé sous pression EN AB - 46100
Couleur	Noir
Fabrication	Revêtement en poudre

Électronique

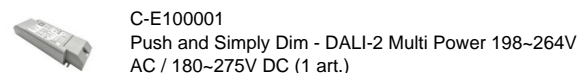
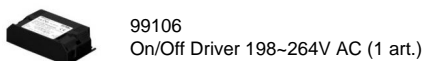
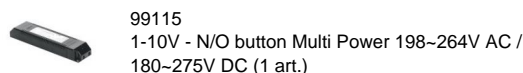

Cables Electrification

Cable connector	MALE JST SMR-02V-B
Cable connector	FEMALE JST SMP-02V-BC



Downlights | 1 arrayLED 18 W DC 500 mA | CRI 90
82474W15

Single emission recessed downlights for indoor application. The warm white LED light source with a spot light distribution is composed of 1 arrayed LEDs with CCT of 3000 K and a CRI 90; the source luminous flux is 2818 lm, with a 156.6 lm/W nominal luminous efficacy.

The device body is made of die-cast aluminium en ab - 46100 and features a black finish, processed by means of powder coating. The ingress protection degree is IP40; the total weight is of 0.375 kg. The power supply driver is not provided and is to be ordered separately.

The total absorbed power is 18 W. The power supply cable is included and features a 0.15 m length.

The device features protection class III and can be ceiling-mounted, with a 76 mm diameter hole (in plasterboard) with an outer casing, code 89374(for concrete or masonry).

Compliant with the EN 60598-1 standard and its specific provisions.

Classe d'efficacité énergétique

Ce produit contient une source lumineuse de classe d'efficacité énergétique E.

Caractéristiques Techniques de l'éclairage

Light Output Ratio (LOR)	79 %
Flux lumineux (source)	2818 lm
Flux lumineux du luminaire	2249 lm
Consumption	18 W
Efficacité lumineuse du luminaire	124 lm/W
Température de couleur	3000 K
Standards de Concordance de Couleur	2 Step MacAdam
Indice de rendu chromatique	90 Ra
Colour Rendering Index	60 R9
Black Body Locus	On
Température standard de l'environnement de	-20 / +50°C
Température typique sur le verre	40°C

LED Life / Failure Ratio

L70 B10 C0 252000h (at Tj 65 Ta 25)

UGR

UGR axial	15.7
UGR transversal	15.9
X=4H Y=8H	S=0.25H
Reflection factor	70/50/20

OPTICAL

Optique C0/C180	16°
Optique C90/C270	Symmetrical

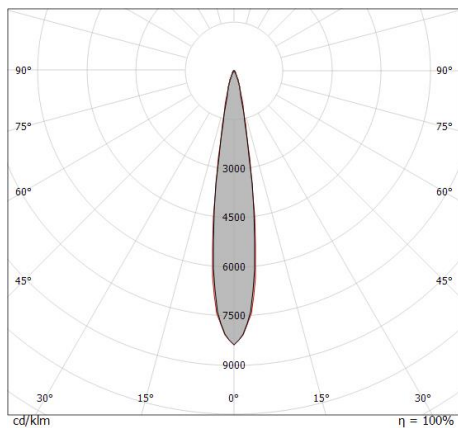

Distance [m]	Cone diameter [m]	illuminance [lx]
0.5	0.16 0.15	E(0°) 75414 E(C90) 8.1° 36829 E(C0) 8.3° 36841
1.0	0.28 0.29	E(0°) 18854 E(C90) 8.1° 9207 E(C0) 8.3° 9210
1.5	0.43 0.44	E(0°) 8379 E(C90) 8.1° 4092 E(C0) 8.3° 4093
2.0	0.57 0.58	E(0°) 4713 E(C90) 8.1° 2302 E(C0) 8.3° 2303
2.5	0.71 0.73	E(0°) 3017 E(C90) 8.1° 1473 E(C0) 8.3° 1474
3.0	0.85 0.88	E(0°) 2095 E(C90) 8.1° 1023 E(C0) 8.3° 1023

— C0/C180 (Half-peak divergence: 16.6°)
— C90/C270 (Half-peak divergence: 16.2°)



Boîtier d'encastrement
position d'installation: plafond; type installation: maçonnerie L=200mm, H=113mm, D=137mm.
Matériau:polypropylène, couleur:blanc.

Code
89373

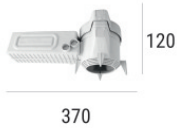

Boîtier d'encastrement
position d'installation: plafond; type installation: maçonnerie L=370mm, H=120mm, D=200mm.
Matériau:polypropylène, couleur:blanc.

Code
89374

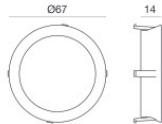

Bague décorative blanche

Code
99901

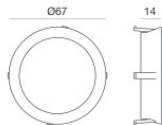

Bague décorative de couleur or

Code
99902

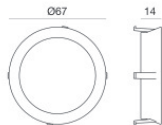

Bague décorative couleur cuivre

Code
99903

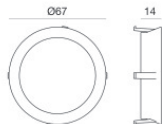

Bague décorative en chrome

Code
99904