

Pound_Focus

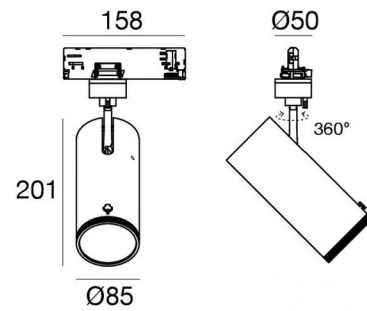

Projecteurs | 198-264 V
1 arrayLED 32.5 W DC - 37 W AC | CRI 98
82449N85



Données techniques	
Typologie	Rail
Position d'installation	Plafond
Environnement d'installation	Intérieur
Source lumineuse	LED
Circuit structure	arrayLED
Optique	Adjustable Focus
Light emission direction	frontal
Puissance nominale	32.5 W DC
Pouvoir total	37 W
Flux lumineux (source)	3790 lm
Tension d'entrée nominale	220 - 240 V AC
Plage de tension d'entrée	198 - 264 V AC
Frequency	50 - 60 Hz
Température de couleur / Tone	4000 K
Indice de rendu chromatique	98 Ra
C.C. / V.C.	AC
Classe d'isolation	2
IP	IP20
Essai au fil incandescent	850°
Montage direct sur des surfaces normalement inflammables	Oui
CE	Oui
Driver inclus	Driver
Article à intensité variable	Dimming on Board
Orientable	Orientable
angle total (plan vertical)	90 °
angle total (plan horizontal)	360 °
Basculement	Non
Piétinable	Non
Carrossable	Non
Câble inclus	Non
Revêtement en résine	Non
Type d'émission lumineuse	Émission simple
Poids net	0.92 Kg
Protection contre les décharges électrostatiques	Oui
Protection contre les surtensions	2 KV

Finition corps	
Matériau	Aluminium moulé sous pression EN AB - 46100
Couleur	Noir
Fabrication	Revêtement en poudre

Projecteurs | 198-264 V | 1 arrayLED 32.5 W DC - 37 W AC | CRI 98 | Angle optique maximal
82449N85

Single emission projectors for indoor application. The natural white LED light source with a adjustable focus light distribution is composed of 1 arrayed LEDs with CCT of 4000 K and a CRI 98; the source luminous flux is 3790 lm, with a 116.6 lm/W nominal luminous efficacy.

The device body is made of die-cast aluminium en ab - 46100 and features a black finish, processed by means of powder coating. The ingress protection degree is IP20; the total weight is of 0.92 kg.

The total absorbed power is 37 W.

The device features protection class II and can be ceiling-mounted.

Compliant with the EN 60598-1 standard and its specific provisions.

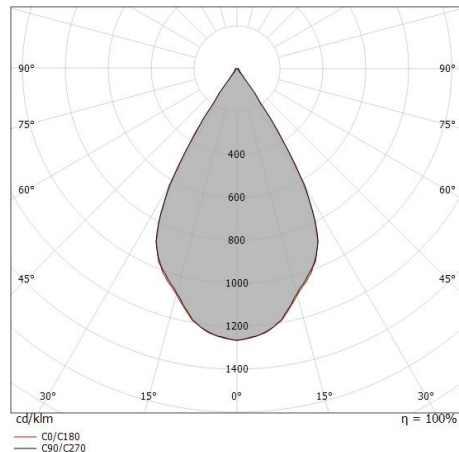

Distance [m]	Cone diameter [m]	illuminance [lx]
0.5	0.58 0.57	E(0°) 11047 E(C90) 29.9° 3611 E(C0) 29.7° 3644
1.0	1.15 1.14	E(0°) 2763 E(C90) 29.9° 903 E(C0) 29.7° 911
1.5	1.73 1.71	E(0°) 1227 E(C90) 29.9° 401 E(C0) 29.7° 405
2.0	2.30 2.28	E(0°) 690 E(C90) 29.9° 226 E(C0) 29.7° 228
2.5	2.88 2.85	E(0°) 442 E(C90) 29.9° 144 E(C0) 29.7° 146
3.0	3.45 3.42	E(0°) 307 E(C90) 29.9° 100 E(C0) 29.7° 101

— C0/C180 (Half-peak divergence: 59.4°)
 — C90/C270 (Half-peak divergence: 59.8°)

Classe d'efficacité énergétique

Ce produit contient une source lumineuse de classe d'efficacité énergétique F.

Caractéristiques Techniques de l'éclairage

Light Output Ratio (LOR)	57 %
Flux lumineux (source)	3790 lm
Flux lumineux du luminaire	2184 lm
Consumption	37 W
Efficacité lumineuse du luminaire	59 lm/W
Température de couleur	4000 K
Standards de Concordance de Couleur	2 Step MacAdam
Indice de rendu chromatique	98 Ra
Black Body Locus	On
Température standard de l'environnement de	-20 / +50°C
Température typique sur le verre	40°C

LED Life / Failure Ratio

L70 B10 C0 252000h (at Tj 65 Ta 25)

UGR

UGR axial	20.7
UGR transversal	20.6
X=4H Y=8H	S=0.25H
Reflection factor	70/50/20

OPTICAL

Optique C0/C180	59°
Light distribution simmetry	Symmetrical

COLOR VECTOR GRAPHIC

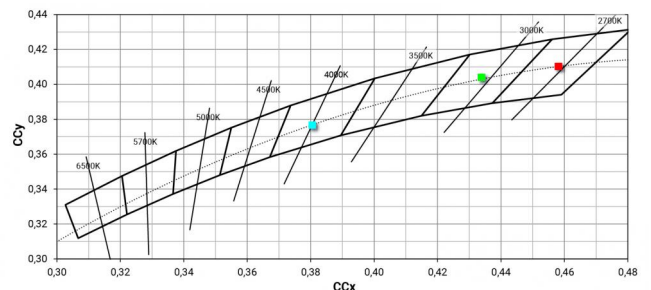
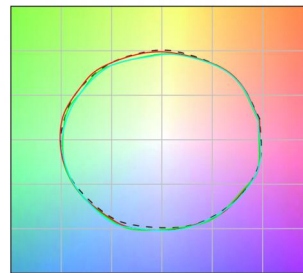



Projecteurs | 198-264 V | 1 arrayLED 32.5 W DC - 37 W AC | CRI 98 | Angle optique

minimum

82449N85

Single emission projectors for indoor application. The natural white LED light source with a adjustable focus light distribution is composed of 1 arrayed LEDs with CCT of 4000 K and a CRI 98; the source luminous flux is 3790 lm, with a 116.6 lm/W nominal luminous efficacy.

The device body is made of die-cast aluminium en ab - 46100 and features a black finish, processed by means of powder coating. The ingress protection degree is IP20; the total weight is of 0.92 kg.

The total absorbed power is 37 W.

The device features protection class II and can be ceiling-mounted.

Compliant with the EN 60598-1 standard and its specific provisions.

Classe d'efficacité énergétique

Ce produit contient une source lumineuse de classe d'efficacité énergétique F.

Caractéristiques Techniques de l'éclairage

Light Output Ratio (LOR)	27 %
Flux lumineux (source)	3790 lm
Flux lumineux du luminaire	1046 lm
Consumption	37 W
Efficacité lumineuse du luminaire	28 lm/W
Température de couleur	4000 K
Standards de Concordance de Couleur	2 Step MacAdam
Indice de rendu chromatique	98 Ra
Black Body Locus	On
Température standard de l'environnement de	-20 / +50°C
Température typique sur le verre	40°C

LED Life / Failure Ratio

L70 B10 C0 252000h (at Tj 65 Ta 25)

UGR

UGR axial	11.3
UGR transversal	11.3
X=4H Y=8H	S=0.25H
Reflection factor	70/50/20

OPTICAL

Optique C0/C180	16°
Light distribution simmetry	Symmetrical

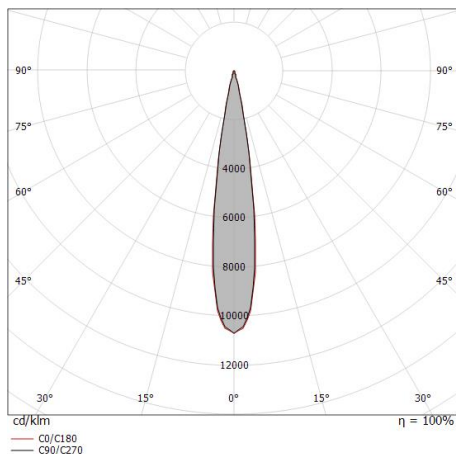

Distance [m]	Cone diameter [m]	illuminance [lx]
0.5	0.15	E(0°) 44803 E(C90) 22187 E(C0) 21738
1.0	0.29	E(0°) 11201 E(C90) 5547 E(C0) 5435
1.5	0.43	E(0°) 4978 E(C90) 2465 E(C0) 2415
2.0	0.58	E(0°) 2800 E(C90) 1387 E(C0) 1359
2.5	0.72	E(0°) 1792 E(C90) 887 E(C0) 870
3.0	0.86	E(0°) 1245 E(C90) 616 E(C0) 604

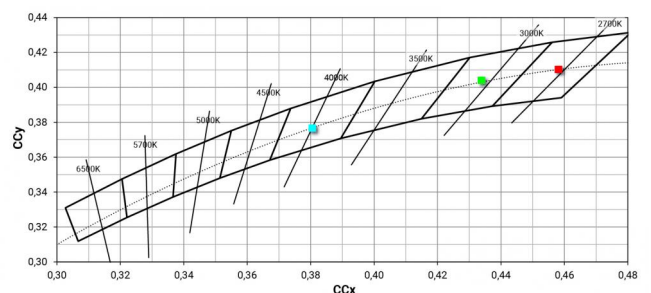
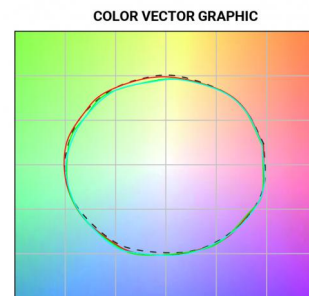



		<p>Source de courant Matériau:PC, couleur:blanc.</p>	<p>Code <u>81033</u></p>
		<p>Source de courant Matériau:PC, couleur:blanc.</p>	<p>Code <u>81036</u></p>
		<p>Source de courant Matériau:PC, couleur:noir.</p>	<p>Code <u>81037</u></p>
		<p>Source de courant Matériau:PC, couleur:noir.</p>	<p>Code <u>81034</u></p>
		<p>Bouchon Matériau:PC, couleur:blanc.</p>	<p>Code <u>80999</u></p>
		<p>Bouchon Matériau:PC, couleur:noir.</p>	<p>Code <u>81000</u></p>
		<p>Bouchon Matériau:PC, couleur:blanc.</p>	<p>Code <u>81002</u></p>
		<p>Bouchon Matériau:PC, couleur:noir.</p>	<p>Code <u>81003</u></p>

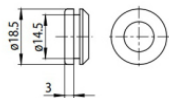

Bouchon
Matériau:blanc.

Code
81084

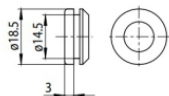

Bouchon
Matériau:noir, couleur:noir.

Code
81085



Rosace
Matériau:plastique, couleur:blanc.

Code
81012

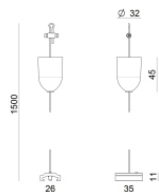

Rosace
Matériau:plastique, couleur:noir.

Code
81014

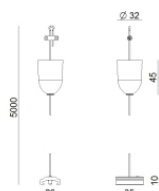

Rosace
Matériau:plastique, couleur:blanc.

Code
81013



Rosace
Matériau:plastique, couleur:noir.

Code
81015



Étrier
L=35mm, H=14mm, D=24mm.
Matériau:Aluminium, couleur:brillant.

Finish
Anod. Al. **Code**
81086



Étrier
L=180mm, H=24mm, D=26mm.
Matériau:Aluminium, couleur:Aluminium Anodisé, fabrication :Anodisation.

Finish
Code
81024



Étrier

L=180mm, H=24mm, D=20mm.

Matériau:Aluminium, couleur:blanc RAL 9010, fabrication :Vernissage.

Finish

White

Code

81025



Étrier

L=180mm, H=24mm, D=20mm.

Matériau:Aluminium, couleur:noir RAL 9005, fabrication :Vernissage.

Finish

Black

Code

81026



Étrier

L=35mm, H=14mm, D=24mm.

Matériau:Aluminium, couleur:blanc, fabrication :Vernissage.

Finish

White

Code

81087



Étrier

L=35mm, H=14mm, D=24mm.

Matériau:Aluminium, couleur:Noir, fabrication :Vernissage.

Finish

Black

Code

81088

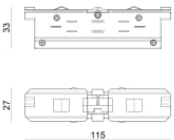

jonction câbles

Typologie linear.

Matériau:PC, couleur:blanc.

Finish

White

Code

81039

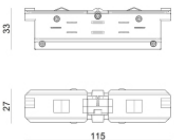

jonction câbles

Typologie linear.

Matériau:PC, couleur:noir.

Finish

Black

Code

81040



jonction câbles

Typologie linear.

Matériau:PC, couleur:blanc.

Finish

White

Code

81042

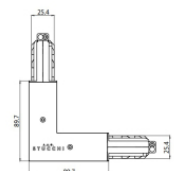

jonction câbles

Typologie linear.

Matériau:PC, couleur:blanc.

Finish

White

Code

81045



		<p>jonction câbles Typologie linear. Matériau:PC, couleur:blanc.</p>	<p>Finish White</p>	<p>Code 81048</p>
		<p>jonction câbles Typologie flexible curve. Matériau:PC, couleur:blanc.</p>	<p>Finish White</p>	<p>Code 81066</p>
		<p>jonction câbles Typologie linear. Matériau:PC, couleur:blanc.</p>	<p>Finish White</p>	<p>Code 81063</p>
		<p>jonction câbles Typologie linear. Matériau:PC, couleur:blanc.</p>	<p>Finish White</p>	<p>Code 81051</p>
		<p>jonction câbles Typologie linear. Matériau:PC, couleur:blanc.</p>	<p>Finish White</p>	<p>Code 81054</p>
		<p>jonction câbles Typologie linear. Matériau:PC, couleur:blanc.</p>	<p>Finish White</p>	<p>Code 81057</p>
		<p>jonction câbles Typologie linear. Matériau:PC, couleur:blanc.</p>	<p>Finish White</p>	<p>Code 81060</p>
		<p>jonction câbles Typologie linear. Matériau:PC, couleur:noir.</p>	<p>Finish Black</p>	<p>Code 81043</p>



		<p>jonction câbles Typologie linear. Matériau:PC, couleur:noir.</p>	<p>Finish Black</p>	<p>Code 81046</p>
		<p>jonction câbles Typologie linear. Matériau:PC, couleur:noir.</p>	<p>Finish Black</p>	<p>Code 81049</p>
		<p>jonction câbles Typologie flexible curve. Matériau:PC, couleur:noir.</p>	<p>Finish Black</p>	<p>Code 81067</p>
		<p>jonction câbles Typologie linear. Matériau:PC, couleur:noir.</p>	<p>Finish Black</p>	<p>Code 81064</p>
		<p>jonction câbles Typologie linear. Matériau:PC, couleur:noir.</p>	<p>Finish Black</p>	<p>Code 81052</p>
		<p>jonction câbles Typologie linear. Matériau:PC, couleur:noir.</p>	<p>Finish Black</p>	<p>Code 81055</p>
		<p>jonction câbles Typologie linear. Matériau:PC, couleur:noir.</p>	<p>Finish Black</p>	<p>Code 81058</p>
		<p>jonction câbles Typologie linear. Matériau:PC, couleur:noir.</p>	<p>Finish Black</p>	<p>Code 81061</p>



Suspension
Matériau:plastique, couleur:blanc.

Code
81006



Suspension
Matériau:plastique, couleur:blanc.

Code
81007

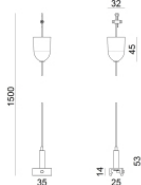

Suspension
Matériau:plastique, couleur:noir.

Code
81008

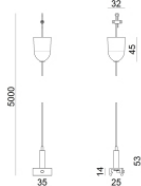

Suspension
Matériau:plastique, couleur:noir.

Code
81009



Suspension
Matériau:plastique, couleur:blanc.

Code
81018



Suspension
Matériau:plastique, couleur:noir.

Code
81019



Suspension
Matériau:plastique, couleur:blanc.

Code
81021



Suspension
Matériau:plastique, couleur:noir.

Code
81022



		Cache-fils Matériau:PC, couleur:blanc.	Code <u>81069</u>
		Cache-fils Matériau:PC, couleur:blanc.	Code <u>81072</u>
		Cache-fils Matériau:PC, couleur:blanc.	Code <u>81075</u>
		Cache-fils Matériau:PC, couleur:blanc.	Code <u>81078</u>
		Cache-fils Matériau:PC, couleur:blanc.	Code <u>81081</u>
		Cache-fils Matériau:PC, couleur:noir.	Code <u>81070</u>
		Cache-fils Matériau:PC, couleur:noir.	Code <u>81073</u>
		Cache-fils Matériau:PC, couleur:noir.	Code <u>81076</u>



		<p>Cache-fils Matériau:PC, couleur:noir.</p>	<p>Code <u>81079</u></p>
		<p>Cache-fils Matériau:PC, couleur:noir.</p>	<p>Code <u>81082</u></p>
		<p>Cache-fils Matériau:blanc.</p>	<p>Code <u>83249</u></p>
		<p>Cache-fils Matériau:noir, couleur:noir.</p>	<p>Code <u>83250</u></p>
			<p>Code <u>81094</u></p>
			<p>Code <u>81091</u></p>
			<p>Code <u>81095</u></p>
			<p>Code <u>81093</u></p>



	Outil	Code	
		81005	
		<p>Rail Longueur: 1000mm; Type rail: Standard. Matériau:Aluminium, couleur:Blanc, fabrication :Vernissage.</p>	<p>Finish Code White 80990</p>
		<p>Rail Longueur: 2000mm; Type rail: Standard. Matériau:Aluminium, couleur:Blanc, fabrication :Vernissage.</p>	<p>Finish Code White 80991</p>
		<p>Rail Longueur: 3000mm; Type rail: Standard. Matériau:Aluminium, couleur:Blanc, fabrication :Vernissage.</p>	<p>Finish Code White 80992</p>
		<p>Rail Longueur: 1000mm; Type rail: Standard. Matériau:Aluminium, couleur:Noir, fabrication :Vernissage.</p>	<p>Finish Code Black 80993</p>
		<p>Rail Longueur: 2000mm; Type rail: Standard. Matériau:Aluminium, couleur:Noir, fabrication :Vernissage.</p>	<p>Finish Code Black 80994</p>
		<p>Rail Longueur: 3000mm; Type rail: Standard. Matériau:Aluminium, couleur:Noir, fabrication :Vernissage.</p>	<p>Finish Code Black 80995</p>
		<p>Rail Longueur: 1000mm; Type rail: Standard. Matériau:Aluminium, couleur:Blanc, fabrication :Vernissage.</p>	<p>Finish Code White 83336</p>

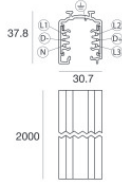

Rail

Longueur: 2000mm; Type rail: Standard.

Matériau:Aluminium, couleur:Blanc, fabrication :Vernissage.

Finish

White

Code

83337

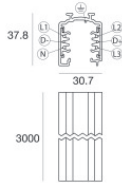

Rail

Longueur: 3000mm; Type rail: Standard.

Matériau:Aluminium, couleur:Blanc, fabrication :Vernissage.

Finish

White

Code

83338

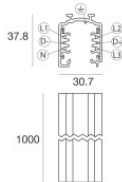
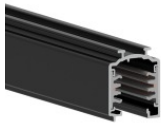

Rail

Longueur: 1000mm; Type rail: Standard.

Matériau:Aluminium, couleur:Noir, fabrication :Vernissage.

Finish

Black

Code

83339

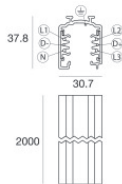
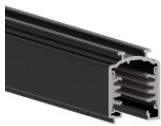

Rail

Longueur: 2000mm; Type rail: Standard.

Matériau:Aluminium, couleur:Noir, fabrication :Vernissage.

Finish

Black

Code

83340

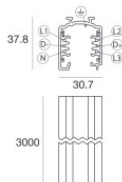
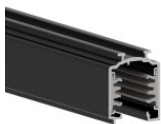

Rail

Longueur: 3000mm; Type rail: Standard.

Matériau:Aluminium, couleur:Noir, fabrication :Vernissage.

Finish

Black

Code

83341