

Pound_Wall

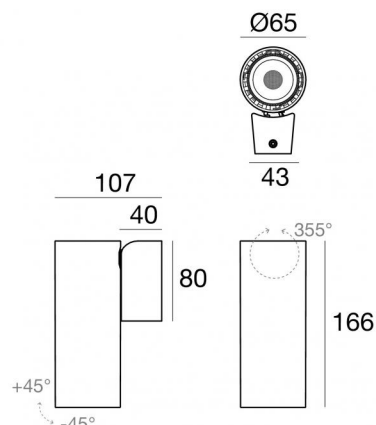

Lampe murale | 100-264 V | 1 arrayLED 17.5 W DC - 19.5 W AC | CRI 90
81997M30

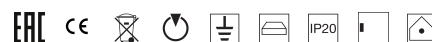

Données techniques	
Typologie	Surface
Position d'installation	Mur
Environnement d'installation	Intérieur
Source lumineuse	LED
Circuit structure	arrayLED
Optique	Medium Flood
Light emission direction	downward
Puissance nominale	17.5 W DC
Pouvoir total	19.5 W
Flux lumineux (source)	2692 lm
Tension d'entrée nominale	220 - 240 V AC
Plage de tension d'entrée	100 - 264 V AC
Frequency	50 - 60 Hz
Température de couleur / Tone	2700 K
Indice de rendu chromatique	90 Ra
C.C. / V.C.	AC
Classe d'isolation	1
IP	IP20
Essai au fil incandescent	850°
Montage direct sur des surfaces normalement inflammables	Oui
CE	Oui
Driver inclus	Driver
Article à intensité variable	Non
Orientable	Orientable
angle total (plan vertical)	90 °
angle total (plan horizontal)	355 °
Basculement	Non
Piétinable	Non
Carrossable	Non
Câble inclus	Non
Revêtement en résine	Non
Type d'émission lumineuse	Émission simple
Poids net	0.8 Kg
Protection contre les décharges électrostatiques	Oui
Protection contre les surtensions	1.85 KV
Technologie optique	Anti - Glare

Finition corps	
Matériau	Aluminium moulé sous pression EN AB - 46100
Couleur	Blanc
Fabrication	Revêtement en poudre

Pound_Wall



Lampe murale | 100-264 V | 1 arrayLED 17.5 W DC - 19.5 W AC | CRI 90
81997M30

Single emission wall lights for indoor application. The super warm white LED light source with a medium flood light distribution is composed of 1 arrayed LEDs with CCT of 2700 K and a CRI 90; the source luminous flux is 2692 lm, with a 153.8 lm/W nominal luminous efficacy.

The device body is made of die-cast aluminium en ab - 46100 and features a white finish, processed by means of powder coating. The ingress protection degree is IP20; the total weight is of 0.8 kg.

The total absorbed power is 19.5 W.

The device features protection class I and can be wall lights-mounted.

Compliant with the EN 60598-1 standard and its specific provisions.

Classe d'efficacité énergétique

Ce produit contient une source lumineuse de classe d'efficacité énergétique E.

Caractéristiques Techniques de l'éclairage

Light Output Ratio (LOR)	68 %
Flux lumineux (source)	2692 lm
Flux lumineux du luminaire	1833 lm
Consumption	19.5 W
Efficacité lumineuse du luminaire	94 lm/W
Température de couleur	2700 K
Standards de Concordance de Couleur	2 Step MacAdam
Indice de rendu chromatique	90 Ra
Colour Rendering Index	60 R9
Black Body Locus	On
Température standard de l'environnement de	-20 / +50°C
Température typique sur le verre	40°C

LED Life / Failure Ratio

L70 B10 C0 252000h (at Tj 65 Ta 25)

UGR

UGR axial	18
UGR transversal	17.9
X=4H Y=8H	S=0.25H
Reflection factor	70/50/20

OPTICAL



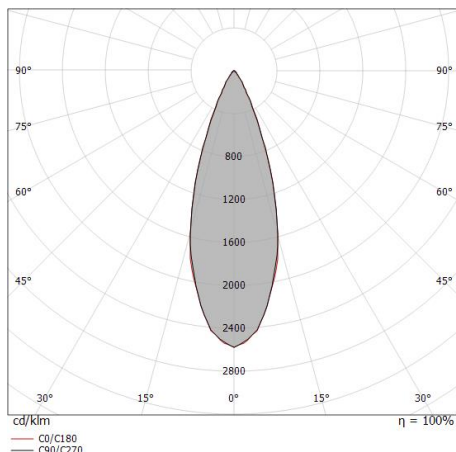
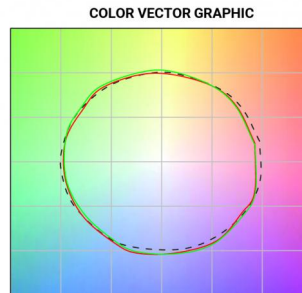



Optique C0/C180	35°
Optique C90/C270	Symmetrical



Distance [m]	Cone diameter [m]	illuminance [lx]	E(0°)	E(C0)	E(C180)
0.5	0.31	18875	17.4°	8237	8237
1.0	0.63	4719	17.4°	2059	2059
1.5	0.94	2097	17.4°	915	915
2.0	1.25	1180	17.4°	515	515
2.5	1.57	755	17.4°	329	329
3.0	1.88	524	17.4°	229	229

Distance [m] Cone diameter [m] Illuminance [lx]
— C0/C180 (Half-peak divergence: 34.8°)



	<p>Diffuseur Type de diffuseur: filtro ellittico. Matériau:Pom-C, couleur:Noir.</p>	<p>Code <u>99781</u></p>
	<p>anti-éblouissement Type anti-éblouissement: grille en nid d'abeille. Matériau:Pom-C, couleur:Noir.</p>	<p>Code <u>99780</u></p>
	<p>anti-éblouissement Type anti-éblouissement: frangiluce a croce. Matériau:Pom-C, couleur:Noir.</p>	<p>Code <u>99779</u></p>
	<p>anti-éblouissement Type anti-éblouissement: schermo cilindrico 45°. Matériau:Pom-C, couleur:Noir.</p>	<p>Code <u>99782</u></p>
	<p>Optique Distribution de la lumière: spot,Matériau revêtement: polycarbonate résistant aux uv</p>	<p>Code <u>99827</u></p>
	<p>Optique Distribution de la lumière: medium flood,Matériau revêtement: polycarbonate résistant aux uv,polycarbonate résistant aux uv,polycarbonate résistant aux uv</p>	<p>Code <u>99828</u></p>
	<p>Optique Distribution de la lumière: flood,Matériau revêtement: polycarbonate résistant aux uv,polycarbonate résistant aux uv,polycarbonate résistant aux uv</p>	<p>Code <u>99829</u></p>