

# Prolamp RGBW

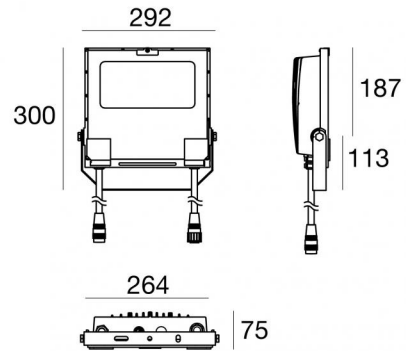

Projecteurs | 8 x powerLEDs 59 W DC 48 V  
RGBW - 3000  
81949V15



Données techniques	
Typologie	Surface
Position d'installation	Mur - Plafond - Sol
Environnement d'installation	Extérieur
Source lumineuse	LED
Circuit structure	powerLEDs
Optique	Spot
Light emission direction	frontal
Puissance nominale	59 W DC
Température de couleur / Tone	RGBW - 3000 K
C.C. / V.C.	CV
Classe d'isolation	3
IP	IP67
IK	IK08
Essai au fil incandescent	850°
Montage direct sur des surfaces normalement inflammables	Oui
CE	Oui
Driver inclus	Control unit
Article à intensité variable	DMX-RDM
Orientable	Orientabile
angle total (plan vertical)	180 °
Basculement	Non
Piétinable	Non
Carrossable	Non
Câble inclus	Oui
Longueur du câble	0.3 m
Revêtement en résine	Non
Type d'émission lumineuse	Émission simple
Poids net	3.8 Kg
Protection contre les décharges électrostatiques	Oui
Protection contre les surtensions	4 KV
Caractéristiques technologiques du produit	TCS

## Finition corps

Matériau	Aluminium moulé sous pression EN AB - 46100
Couleur	Noir
Fabrication	Anodisation à pores ouverts + revêtement par poudre

## Finition diffuseur

Matériau	Verre extra clair - trempé
Couleur	transparent
Fabrication	Séigraphie

## Finition support de fixation

Matériau	Acier AISI 304
Couleur	acier

## Électronique

	99785 On/Off Driver 100~305V AC / 142~431V DC 240 W (1 - 4 art.)
---	---

	C-E700026 DMX Controller (1 art.)
---	--------------------------------------

## Cables Electrification+signal

IP (locked condition)	67
Cable connector	AllinONE Male Plug 6 Pin
Cable connector	ALLinONE Female Socket 6 Pin

## Lumen RGBW

N. Led	Rouge	Vert	Bleu	blanc
8	592 lm	968 lm	168 lm	976 lm

# Prolamp RGBW



Projecteurs | 8 x powerLEDs 59 W DC 48 V | RGBW - 3000  
**81949V15**

Single emission projectors for outdoor application. The RGBW - 3000 K LED light source with a spot light distribution is composed of 8 powered LEDs with CCT of RGB-W 3000 K.

The device body is made of die-cast aluminium en ab - 46100 and features a black finish, processed by means of open pore anodizing + powder coating; the diffuser is made of extra clear glass - tempered with a silk-screening treatment. The ingress protection degree is IP67; the total weight is of 3.8 kg.

The total absorbed power is 59 W. The power supply cable is included and features a 0.3 m length.

The device features protection class III and can be wall lights, ceiling or floor-mounted.

Compliant with the EN 60598-1 standard and its specific provisions.

## Classe d'efficacité énergétique









Ce produit contient une source lumineuse de classe d'efficacité énergétique G.

Température standard de l'environnement de	-20 / +50°C
Température typique sur le verre	40°C

## LED Life / Failure Ratio

L70 B10 C0 202460h (at Tj 60 Ta 25 )



<p><b>L. 1m</b></p> 	<p>Câble et connecteur Type câble power + signal cable allinone; Longueur 1000 mm; isolation doppio con schermatura per segnale; diamètre externe: 12.6 mm; couleurs: blanc - bleu - rouge - gris - brun - jaune-vert.</p>	<p><b>Code</b> <u>98660</u></p>
<p><b>L. 5m</b></p> 	<p>Câble et connecteur Type câble power + signal cable allinone; Longueur 5000 mm; isolation doppio con schermatura per segnale; diamètre externe: 12.6 mm; couleurs: blanc - bleu - rouge - gris - brun - jaune-vert.</p>	<p><b>Code</b> <u>98661</u></p>
<p><b>L. 1m</b></p> 	<p>Câble et connecteur Type câble power + signal cable allinone; Longueur 1000 mm; isolation doppio con schermatura per segnale; diamètre externe: 12.6 mm.</p>	<p><b>Code</b> <u>98662</u></p>
<p><b>L. 5m</b></p> 	<p>Câble et connecteur Type câble power + signal cable allinone; Longueur 5000 mm; isolation doppio con schermatura per segnale; diamètre externe: 12.6 mm.</p>	<p><b>Code</b> <u>98663</u></p>
 	<p>Connecteur - Start splitter Type câble power + signal cable allinone; Longueur 5000 + 5000 + 200 mm; isolation doppio con schermatura per segnale.</p>	<p><b>Code</b> <u>98985</u></p>
 	<p>Connecteur - Continuity splitter Type câble power + signal cable allinone; Longueur 200 + 200 + 5000 mm; isolation doppio con schermatura per segnale.</p>	<p><b>Code</b> <u>99390</u></p>
	<p>Connecteur - Adaptateur de fermeture de ligne DMX pour câbles ALLinONE Type câble power + signal cable allinone; ; isolation doppio con schermatura per segnale.</p>	<p><b>Code</b> <u>98986</u></p>