

Navata Pound Shaper

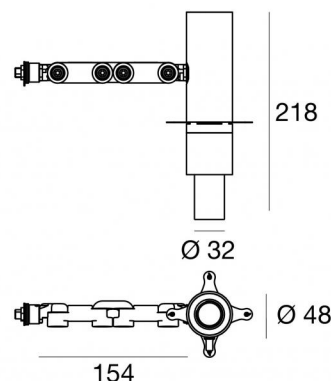

Projecteurs | 1 arrayLED 11 W DC 300 mA | CRI 98
76742M66











Données techniques

Typologie	Surface
Position d'installation	Mur - Plafond - Sol
Environnement d'installation	Intérieur
Source lumineuse	LED
Circuit structure	arrayLED
Optique	Shaper Short Distance
Light emission direction	frontal
Puissance nominale	11 W DC
Flux lumineux (source)	1019 lm
Plage de tension d'entrée	300mA
Température de couleur / Tone	2700 K
Indice de rendu chromatique	98 Ra
C.C. / V.C.	CC
Classe d'isolation	3
IP	IP20
Essai au fil incandescent	850°
Montage direct sur des surfaces normalement inflammables	Oui
CE	Oui
Driver inclus	Non
Article à intensité variable	DALI - 1-10V
Orientable	Orientable
angle total (plan vertical)	90 °
angle total (plan horizontal)	360 °
Basculement	Non
Piétinable	Non
Carrossable	Non
Câble inclus	Non
Revêtement en résine	Non
Type d'émission lumineuse	Émission simple
Poids net	0.5 Kg
Protection contre les décharges électrostatiques	Non
Protection contre les surtensions	Non

Finition corps

Matériau	Aluminium moulé sous pression EN AB - 46100
Couleur	Blanc
Fabrication	Revêtement en poudre

Électronique

	99734 Multi Power 198~264V AC / 180~275V DC (1 art.)
	99730 DALI - Push and Simply Dim Multi Power 198~264V AC / 180~275V DC (1 art.)
	99938 Multi Power 198~264V AC / 176~264V DC (1 - 2 art.)
	99936 DALI-2 Controller (1 - 2 art.)
	99935 Bluetooth Controller (1 art.)
	99946 DALI Multi Power 198~264V AC / 176~275V DC (1 art.)
	99948 Multi Power 198~264V AC / 176~264V DC (1 art.)
	C-E100006 Multi Power 198~264V AC / 180~275V DC (1 art.)

Navata Pound Shaper



Projecteurs | 1 arrayLED 11 W DC 300 mA | CRI 98
76742M66

Single emission projectors for indoor application. The super warm white LED light source with a shaper short distance light distribution is composed of 1 arrayed LEDs with CCT of 2700 K and a CRI 98; the source luminous flux is 1019 lm, with a 92.6 lm/W nominal luminous efficacy.

The device body is made of die-cast aluminium en ab - 46100 and features a white finish, processed by means of powder coating. The ingress protection degree is IP20; the total weight is of 0.5 kg. The power supply driver is not provided and is to be ordered separately.

The total absorbed power is 11 W.

The device features protection class III and can be wall lights, ceiling or floor-mounted.

Compliant with the EN 60598-1 standard and its specific provisions.

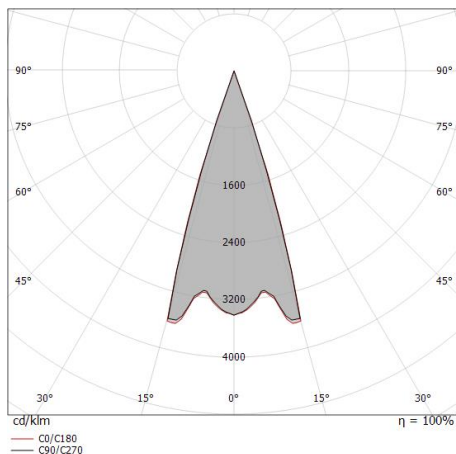

Distance [m]	Cone diameter [m]	illuminance [lx]
0.5	0.32 0.32	E(0°) 1862 E(C90) 864 E(C0) 861
1.0	0.63 0.63	E(0°) 466 E(C90) 216 E(C0) 215
1.5	0.95 0.95	E(0°) 207 E(C90) 96 E(C0) 96
2.0	1.26 1.27	E(0°) 116 E(C90) 54 E(C0) 54
2.5	1.58 1.59	E(0°) 74 E(C90) 35 E(C0) 34
3.0	1.89 1.90	E(0°) 52 E(C90) 24 E(C0) 24

— C0/C180 (Half-peak divergence: 35.2°)
— C90/C270 (Half-peak divergence: 35.0°)

Classe d'efficacité énergétique

Ce produit contient une source lumineuse de classe d'efficacité énergétique G.

Caractéristiques Techniques de l'éclairage

Light Output Ratio (LOR)	13 %
Flux lumineux (source)	1019 lm
Flux lumineux du luminaire	137 lm
Consumption	11 W
Efficacité lumineuse du luminaire	12 lm/W
Température de couleur	2700 K
Standards de Concordance de Couleur	2 Step MacAdam
Indice de rendu chromatique	98 Ra
Black Body Locus	On
Température standard de l'environnement de	-20 / +50°C
Température typique sur le verre	45°C

LED Life / Failure Ratio

L70 B10 C0 252000h (at Tj 65 Ta 25)

UGR

UGR axial	-8.7
UGR transversal	-8.7
X=4H Y=8H	S=0.25H
Reflection factor	70/50/20

OPTICAL

Optique C0/C180	35°
Light distribution simmetry	Symmetrical

COLOR VECTOR GRAPHIC

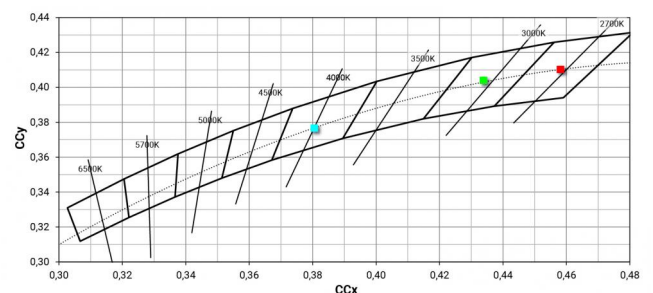

Navata Pound Shaper



Navata Pound Shaper | Projectors | Accessories
76742M66

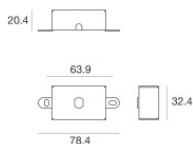

Base pour fixation - Base sans alimentation
Matériau:Fer, couleur:Blanc, fabrication :Vernissage.

Code

98588