

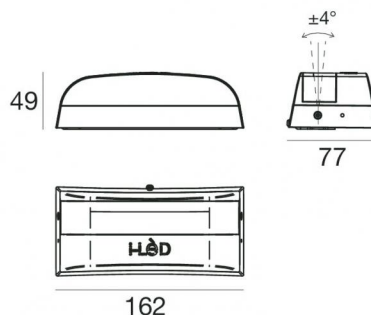

Uplights | 12 x powerLEDs 8 W DC 220 mA | RGB
95750Z18

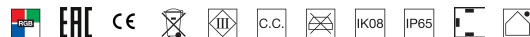

Datos técnicos	
Tipo	Superficie
Posición de instalación	Pared - Techo - Piso
Ambiente de instalación	Exteriores
Fuente de luz	LED
Circuit structure	powerLEDs
Óptica	Elíptico Narrow Spot (Wall Grazing)
Light emission direction	upward
Potencia nominal	8 W DC
Rango de voltaje de entrada	220mA
CCT / Tone	RGB
C.C. / C.V.	CC
Clase de aislamiento	3
IP	IP65
IK	IK08
Test del hilo incandescente	850°
Montaje directo sobre superficies normalmente inflamables	Sí
CE	Sí
Driver incluido.	No
Artículo regulable	Sí
Orientabilidad	Orientabile
ángulo total (plano vertical)	5 °
Basculación	No
Practicabilidad	No
Transitabilidad	No
Cable incluido.	No
Resinado	No
Tipología de emisión luminosa	Emissione ad arco
Peso neto	0.65 Kg
Protección descargas electrostáticas	No
Protección contra sobretensiones	No

Acabado cuerpo	
Material	Aluminio fundido EN AB - 46100
Color	Negro
Elaboración	Anodizado de poro abierto + pintado con polvo

Acabado difusor	
Material	Policarbonato resistente a los rayos UV
Color	transparente
Elaboración	Pintura líquida

Acabado base	
Material	Aluminio fundido EN AB - 46100
Color	Negro
Elaboración	Anodizado de poro abierto + pintado con polvo

Electrónica	
	C-E500015 DMX-RDM - NFC Multi Channel 4ch. 19~50V DC (1 - 6 art.(24 V)

Lumen RGBW			
N. Led	Rojo	Verde	Azul
12	156 lm	272 lm	92 lm

Uplights | 12 x powerLEDs 8 W DC 220 mA | RGB 95750Z18

Arced diffusion uplights for outdoor application. The RGB LED light source with a elliptic narrow spot (wall grazing) light distribution is composed of 12 powered LEDs.

The device body is made of die-cast aluminium en ab - 46100 and features a black finish, processed by means of open pore anodizing + powder coating; the diffuser is made of uv resistant polycarbonate with a liquid painting treatment. The ingress protection degree is IP65; the total weight is of 0.65 kg. The power supply driver is not provided and is to be ordered separately.

The total absorbed power is 8 W.

The device features protection class III and can be wall lights, ceiling or floor-mounted.

Compliant with the EN 60598-1 standard and its specific provisions.

Características Luminotécnicas

Flujo luminoso de luminaria	286 lm
Consumption	7.5 W
Rendimiento luminoso de las luminarias	38 lm/W
Temperatura estándar del ambiente de servicio	-20 / +50°C
Temperatura típica sobre el vidrio	40°C

LED Life / Failure Ratio

L70 B10 C0 247450h

UGR

UGR axial	10.1
UGR transversal	30.2
X=4H Y=8H	S=0.25H
Reflection factor	70/50/20

OPTICAL

Óptica C90/C270	18°
Óptica C0/C180	140°
Light distribution simmetry	Symmetrical 2 assis

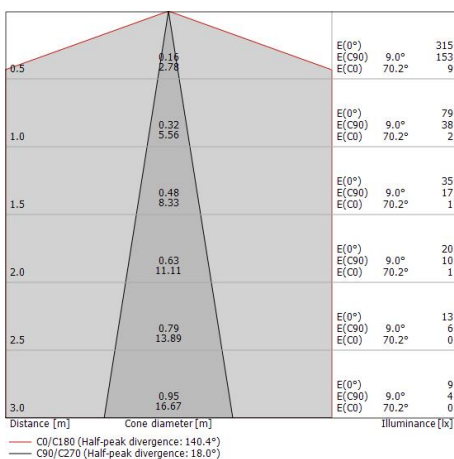
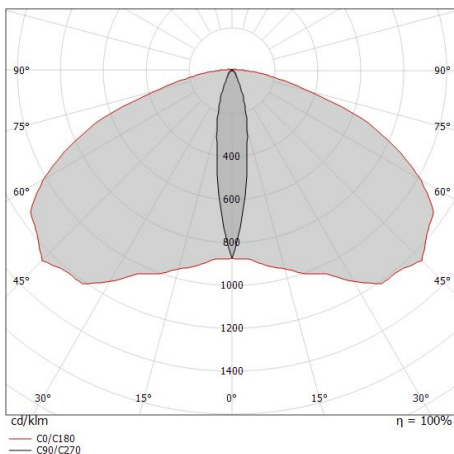

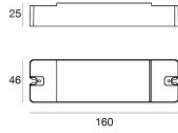

Regulador de intensidad
RF Remote controller

Code

C-E700003

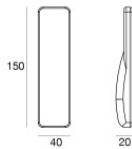

Control remoto por radiofrecuencia

Code

C-W600001