

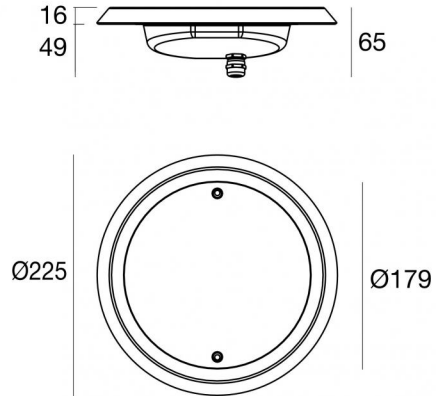

Sumergible | 9 x powerLEDs 38 W DC 700 mA  
 RGBW - 3000  
**84044V40**



Datos técnicos	
Tipo	Frame
Posición de instalación	Pared - Piso
Ambiente de instalación	Exteriores
Fuente de luz	LED
Circuit structure	powerLEDs
Óptica	Medium Wide Flood
Light emission direction	frontal
Potencia nominal	38 W DC
Rango de voltaje de entrada	700mA
CCT / Tone	RGBW - 3000 K
C.C. / C.V.	CC
Clase de aislamiento	3
IP	IP68
Profundidad máxima de instalación	25 m
Restricciones de instalación	Solo bajo el agua
IK	IK10
Test del hilo incandescente	850°
Montaje directo sobre superficies normalmente inflamables	Sí
CE	Sí
Driver incluido.	No
Artículo regulable	Sí
Orientabilidad	No
Basculación	No
Practicabilidad	No
Transitabilidad	No
Cable incluido.	Sí
Largo del cable	5 m
Resinado	Sí
Tipología de emisión luminosa	Una emisión
Peso neto	0.8 Kg
Protección descargas electrostáticas	No
Protección contra sobretensiones	No
Características tecnológicas del producto	Acquastop

Acabado cuerpo	
Material	Acero AISI 316L
Color	acero

Acabado difusor	
Material	Vidrio extra claro - templado
Color	transparente
Elaboración	Serigrafía

Acabado brida	
Material	Acero inoxidable 316
Color	acero
Elaboración	electropulido

#### Electrónica

 83010  
 On/Off Driver 90~264V AC / 127~370V DC 60 W (1 art.)

 83187  
 Push and Simply Dim - DMX-RDM Multi Channel 4ch. 10.8~52.8V DC (1 art.)

Lumen RGBW				
N. Led	Rojo	Verde	Azul	blanco
9	261 lm	675 lm	216 lm	729 lm



Sumergible | 9 x powerLEDs 38 W DC 700 mA | RGBW - 3000  
**84044V40**

Single emission submerged for outdoor application. The RGBW - 3000 K LED light source with a medium wide flood light distribution is composed of 9 powered LEDs with CCT of RGB-W 3000 K.

The device body is made of aisi 316l steel and features a steel finish; the diffuser is made of extra clear glass - tempered with a silk-screening treatment. The ingress protection degree is IP68; the total weight is of 0.8 kg. The power supply driver is not provided and is to be ordered separately.

The total absorbed power is 38 W. The power supply cable is included and features a 5 m length.

The device features protection class III and can be wall lights or floor-mounted with an outer casing, code 83198(for concrete or masonry).

Compliant with the EN 60598-1 standard and its specific provisions.

Temperatura estándar del ambiente de servicio	-20 / +50°C
Temperatura típica sobre el vidrio	40°C

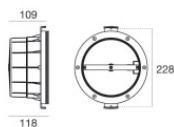

Caja de empotrar - Carcasa exterior para instalación sobre lienzo  
posición de instalación: pared; tipo instalación: albañilería L=213mm, H=213mm,  
D=110mm.  
Material:Plástico ABS, color:negro.

**Code**  
83198

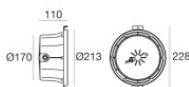
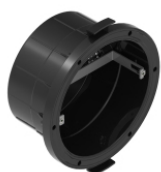

Caja de empotrar - Envoltente IP68 para instalación en mampostería (baldosas o mosaico)  
posición de instalación: pared; tipo instalación: albañilería L=213mm, H=213mm,  
D=110mm.  
Material:Plástico ABS, color:negro.

**Code**  
83142

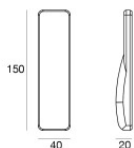

Control remoto por radiofrecuencia

**Code**  
C-W600001

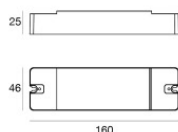

Regulador de intensidad  
RF Remote controller

**Code**  
C-E700003