

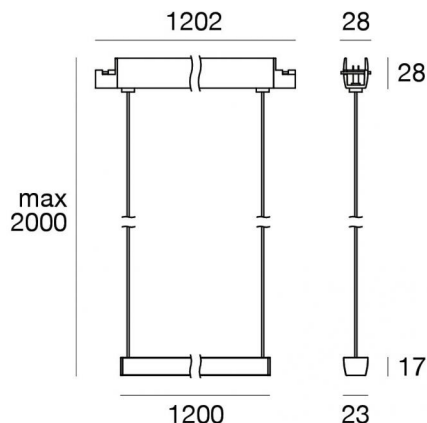

Sistemas - Elementos lineales
144 topLED 29 W DC 24 V | CRI 90
84003W00



Datos técnicos	
Designer	Linea Light
Año de realización	2020
Tipo	Sistemas - Elementos lineales
Posición de instalación	Cable
Ambiente de instalación	Interiores
Fuente de luz	LED
Circuit structure	topLED
Óptica	Difusa
Light emission direction	downward
Potencia nominal	29 W DC
Flujo luminoso (fuente)	2744 lm
Rango de voltaje de entrada	24 V
Frequency	50-60 Hz
CCT / Tone	3000 K
Índice de rendimientos cromático	90 Ra
C.C. / C.V.	CV
Clase de aislamiento	3
IP	IP40
Test del hilo incandescente	850°
Montaje directo sobre superficies normalmente inflamables	Sí
CE	Sí
Driver incluido.	No
C.V. - C.C. Converter	Convertidor 24V incluido
Artículo regulable	P2P
Orientabilidad	No
Basculación	No
Practicabilidad	No
Transitabilidad	No
Cable incluido.	No
Resinado	No
Tipología de emisión luminosa	Una emisión
Peso neto	1.330 Kg
Protección descargas electrostáticas	No
Protección contra sobretensiones	No

Acabado cuerpo

Material	aluminio
Elaboración	Pintura

Acabado difusor

Material	PC
Color	opalino

Acabado montura

Material	aluminio
Elaboración	Pintura

Electrónica

 81416
On/Off Driver 220~240V AC 120 W (1 - 4 art.)

 81417
On/Off Driver 220~240V AC 180 W (1 - 6 art.)

 84018
DALI - DALI-2 - P2P Controller 24V DC 150 W (1 - 5 art.)



Sistemas - Elementos lineales | 144 topLED 29 W DC 24 V | CRI 90
84003W00

Single emission systems or lines for indoor application. The warm white LED light source with a diffused light distribution is composed of 144 topped LEDs with CCT of 3000 K and a CRI 90; the source luminous flux is 2744 lm, with a 94.6 lm/W nominal luminous efficacy.

The device body is made of aluminium and features a 5g 9005 black finish, processed by means of coating; the diffuser is made of PC; the mounting frame is made of aluminium, with a 5g 9005 black finish, processed by means of coating. The ingress protection degree is IP40; the total weight is of 1.330 kg.

The total absorbed power is 29 W.

The device features protection class III and can be cable-mounted, with a x mm hole (in plasterboard).

Compliant with the EN 60598-1 standard and its specific provisions.

Clase de eficiencia energética

Este producto contiene 4 fuentes de luz de clase de eficiencia energética G.

Características Luminotécnicas

Light Output Ratio (LOR)	34 %
Flujo luminoso (fuente)	2744 lm
Flujo luminoso de luminaria	951 lm
Consumption	29 W
Rendimiento luminoso de las luminarias	32 lm/W
Temperatura de color	3000 K
Standard Deviation of Colour Matching	3 Step MacAdam
Índice de rendimientos cromático	90 Ra
Temperatura de unión (luminaria)	80

Temperatura estándar del ambiente de servicio -20 / +50°C

LED Life / Failure Ratio

L70 B20 C0 72500h (at Tj 115 Ta 25)

UGR

UGR axial	22.2
UGR transversal	28.1
X=4H Y=8H	S=0.25H
Reflection factor	70/50/20

OPTICAL

Óptica C90/C270	100°
Óptica C0/C180	139°
Light distribution simmetry	Symmetrical 2 assis

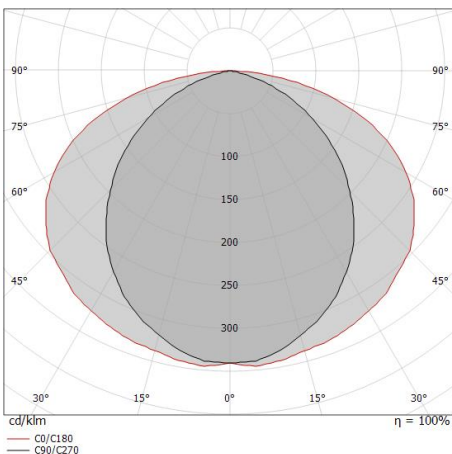

Distance [m]	Cone diameter [m]	illuminance [lx]
0.5	1.19 2.70	E(0°) 1293 E(C90) 172 E(C0) 27
1.0	2.38 5.41	E(0°) 323 E(C90) 43 E(C0) 7
1.5	3.58 8.11	E(0°) 144 E(C90) 19 E(C0) 3
2.0	4.77 10.81	E(0°) 81 E(C90) 11 E(C0) 2
2.5	5.96 13.52	E(0°) 52 E(C90) 7 E(C0) 1
3.0	7.15 16.22	E(0°) 36 E(C90) 5 E(C0) 1

— C0/C180 (Half-peak divergence: 139.4°)
 — C90/C270 (Half-peak divergence: 100.0°)



		<p>Cable Tipología cable power cable; Largo 5000 mm; aislamiento doppio; sección 1.5 mm²; prensacable: no; colores: negro - rojo.</p>	<p>Code <u>81410</u></p>
		<p>Cable Tipología cable power cable; Largo 10000 mm; aislamiento doppio; sección 1.5 mm²; prensacable: no; colores: negro - rojo.</p>	<p>Code <u>81411</u></p>
		<p>Herramienta - Kit de corte y pelado de cables</p>	<p>Code <u>81427</u></p>
		<p>Cable Tipología cable power cable; Largo 1000 mm; aislamiento doppio; sección 1.5 mm²; prensacable: no; colores: negro - rojo.</p>	<p>Code <u>84016</u></p>
		<p>Perfil - L. 1000mm Material:aluminio, elaboración :Pintura.</p>	<p>Code <u>84012</u></p>
		<p>Perfil - L. 2000mm Material:aluminio, elaboración :Pintura.</p>	<p>Code <u>84013</u></p>
		<p>Perfil - L. 3000mm Material:aluminio, elaboración :Pintura.</p>	<p>Code <u>84014</u></p>
		<p>Perfil - Esquina empotrada Material:aluminio, elaboración :Pintura.</p>	<p>Code <u>84015</u></p>



Ink system_LP | Lines | Accessories
84003W00

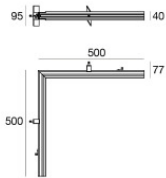

Perfil - Esquina empotrada - IN
Material:aluminio, elaboración :Pintura.

Code
84073

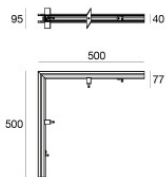

Perfil - Esquina empotrada - OUT
Material:aluminio, elaboración :Pintura.

Code
84074

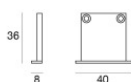

Tapón - 2X
Material:PC, color:negro.

Code
83153

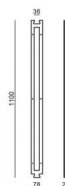

Plantilla

Code
83186