

# Tour\_Projectors

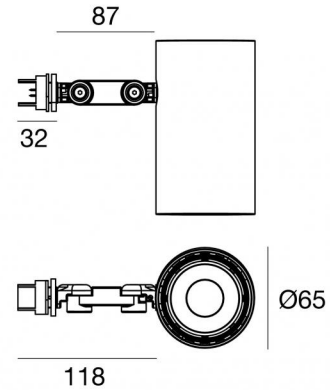

Proyectores | 1 arrayLED 15 W DC 420 mA | CRI 90  
**82757W15**



Datos técnicos	
Tipo	Superficie
Posición de instalación	Techo
Ambiente de instalación	Interiores
Fuente de luz	LED
Circuit structure	arrayLED
Óptica	Spot
Light emission direction	frontal
Potencia nominal	15 W DC
Flujo luminoso (fuente)	2318 lm
CCT / Tone	3000 K
Índice de rendimientos cromático	90 Ra
C.C. / C.V.	DC
Clase de aislamiento	2
IP	IP20
Test del hilo incandescente	850°
Montaje directo sobre superficies normalmente inflamables	Sí
CE	Sí
Artículo regulable	No
Orientabilidad	Orientabile
ángulo total (plano vertical)	180 °
ángulo total (plano horizontal)	360 °
Basculación	No
Practicabilidad	No
Transitabilidad	No
Cable incluido.	No
Resinado	No
Tipología de emisión luminosa	Una emisión
Peso neto	0.53 Kg
Protección descargas electrostáticas	No
Protección contra sobretensiones	No

Acabado cuerpo	
Material	aluminio
Color	Blanco
Elaboración	Pintura



Proyectores | 1 arrayLED 15 W DC 420 mA | CRI 90  
**82757W15**

Single emission projectors for indoor application. The warm white LED light source with a spot light distribution is composed of 1 arrayed LEDs with CCT of 3000 K and a CRI 90; the source luminous flux is 2318 lm, with a 154.5 lm/W nominal luminous efficacy.

The device body is made of aluminium and features a white finish, processed by means of coating. The ingress protection degree is IP20; the total weight is of 0.53 kg.

The total absorbed power is 15 W.

The device features protection class II and can be ceiling-mounted.

Compliant with the EN 60598-1 standard and its specific provisions.

### Clase de eficiencia energética

Este producto contiene una fuente de luz de clase de eficiencia energética E.

### Características Luminotécnicas

Light Output Ratio (LOR)	69 %
Flujo luminoso (fuente)	2318 lm
Flujo luminoso de luminaria	1616 lm
Consumption	15 W
Rendimiento luminoso de las luminarias	107 lm/W
Temperatura de color	3000 K
Standard Deviation of Colour Matching	2 Step MacAdam
Índice de rendimientos cromático	90 Ra
Colour Rendering Index	60 R9
Black Body Locus	On
Temperatura estándar del ambiente de servicio	-20 / +50°C

### LED Life / Failure Ratio

L70 B10 C0 252000h (at Tj 65 Ta 25 )

### UGR

UGR axial	16.6
UGR transversal	16.5
X=4H   Y=8H	S=0.25H
Reflection factor	70/50/20

### OPTICAL

Óptica C0/C180	19°
Light distribution simmetry	Symmetrical

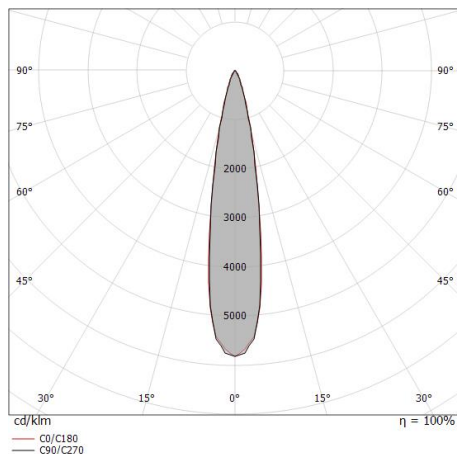

Distance [m]	Cone diameter [m]	Illuminance [lx]	E(0°)	E(C90)	E(C0)
0.5	0.17 0.17	37638	9.7°	18069	18047
1.0	0.34 0.35	9409	9.7°	4517	4512
1.5	0.51 0.52	4182	9.7°	2008	2005
2.0	0.68 0.69	2352	9.7°	1129	1128
2.5	0.85 0.86	1506	9.7°	723	722
3.0	1.03 1.04	1045	9.7°	502	501

— C0/C180 (Half-peak divergence: 19.6°)  
 — C90/C270 (Half-peak divergence: 19.4°)

### COLOR VECTOR GRAPHIC





Proyectoras | 1 arrayLED 15 W DC 420 mA | CRI 90  
**82757W15**

## Components

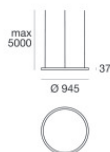







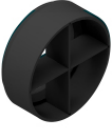

Tour\_Track

**Code**

82753 - 82754 - 82756 - 82755



	<p>Difusor Tipo de difusor: filtro ellittico. Material:Pom-C, color:Negro.</p>	<p><b>Code</b> <u>99781</u></p>
	<p>antideslumbramiento Tipo antideslumbrante: louvre de nido de abeja. Material:Pom-C, color:Negro.</p>	<p><b>Code</b> <u>99780</u></p>
	<p>antideslumbramiento Tipo antideslumbrante: frangiluce a croce. Material:Pom-C, color:Negro.</p>	<p><b>Code</b> <u>99779</u></p>
	<p>antideslumbramiento Tipo antideslumbrante: schermo cilindrico. Material:Pom-C, color:Negro.</p>	<p><b>Code</b> <u>99783</u></p>
	<p>antideslumbramiento Tipo antideslumbrante: schermo cilindrico 45°. Material:Pom-C, color:Negro.</p>	<p><b>Code</b> <u>99782</u></p>
	<p>Óptica Distribución de la luz: spot,Material de revestimiento: policarbonato resistente a los rayos uv</p>	<p><b>Code</b> <u>99827</u></p>
	<p>Óptica Distribución de la luz: medium flood,Material de revestimiento: ,policarbonato resistente a los rayos uv,policarbonato resistente a los rayos uv,policarbonato resistente a los rayos uv</p>	<p><b>Code</b> <u>99828</u></p>
	<p>Óptica Distribución de la luz: flood,Material de revestimiento: ,policarbonato resistente a los rayos uv,policarbonato resistente a los rayos uv,policarbonato resistente a los rayos uv</p>	<p><b>Code</b> <u>99829</u></p>