

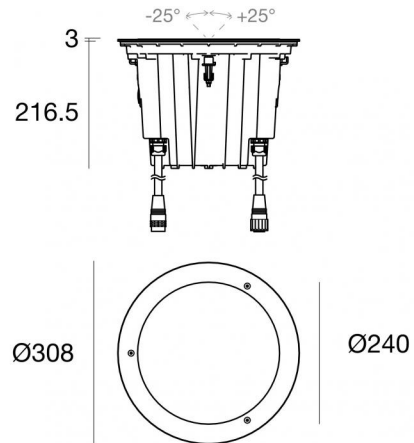

Uplights | 198-264 V AC /180-275 V DC  
24 x powerLEDs 37 W DC - 41 W AC | RGBW - 3000  
**82724V50**



Datos técnicos	
Tipo	Transitable
Posición de instalación	Piso
Ambiente de instalación	Exteriores
Fuente de luz	LED
Circuit structure	powerLEDs
Óptica	Wide Flood
Light emission direction	upward
Potencia nominal	37 W DC
Poder total	41 W
Tensión nominal de entrada	220 - 240 V AC
Rango de voltaje de entrada	198 - 264 V AC
Frequency	50 - 60 Hz
CCT / Tone	RGBW - 3000 K
C.C. / C.V.	AC
Clase de aislamiento	1
IP	IP68
Restricciones de instalación	No para uso bajo el agua
IK	IK10
Test del hilo incandescente	850°
Montaje directo sobre superficies normalmente inflamables	No
CE	Sí
Driver incluido.	Control unit/Driver
Artículo regulable	DMX-RDM
Orientabilidad	No
Basculación	Sí
ángulo total (plano vertical)	50 °
Practicabilidad	Sí
Transitabilidad	5000 Kg
Cable incluido.	Sí
Largo del cable	0.2 m
Resinado	Sí
Tipología de emisión luminosa	Una emisión
Peso neto	8 Kg
Protección descargas electrostáticas	Sí
Protección contra sobretensiones	Sí
Características tecnológicas del producto	Acquastop

### Acabado cuerpo

Material	Aluminio fundido EN AB - 46100
Color	negro
Elaboración	Anodizado de poro abierto + pintado con polvo

### Acabado difusor

Material	Vidrio extra claro - templado
Color	transparente
Elaboración	Serigrafía

### Acabado brida

Material	Acero AISI 316
Color	acero
Elaboración	Cepillado

### Cables Electrification+signal

IP (locked condition)	67
Cable connector	ALLinONE Female Socket 6 Pin
Cable connector	AllinONE Male Plug 6 Pin

### Lumen RGBW

N. Led	Rojo	Verde	Azul	blanco
24	438 lm	894 lm	318 lm	1206 lm

La fuente de alimentación contenida en el dispositivo cumple con la norma IEC 61347-2-13 anexo J y, por lo tanto, puede alimentarse mediante sistemas de alimentación centralizados.



Uplights | 198-264 V AC /180-275 V DC | 24 x powerLEDs 37 W DC - 41 W AC | RGBW - 3000  
**82724V50**

Single emission uplights for outdoor application. The RGBW - 3000 K LED light source with a wide flood light distribution is composed of 24 powered LEDs with CCT of RGB-W 3000 K.

The device body is made of die-cast aluminium en ab - 46100 and features a black finish, processed by means of open pore anodizing + powder coating; the diffuser is made of extra clear glass - tempered with a silk-screening treatment. The ingress protection degree is IP68; the total weight is of 8 kg.

The total absorbed power is 37 W. The power supply cable is included and features a 0.2 m length.

The device features protection class I and can be floor-mounted with an outer casing, code 83096(for concrete or masonry).

Compliant with the EN 60598-1 standard and its specific provisions.

#### Clase de eficiencia energética

Este producto contiene una fuente de luz de clase de eficiencia energética E.



#### Características Luminotécnicas

Standard Deviation of Colour Matching	3 Step MacAdam
Índice de rendimientos cromático	90 Ra
Temperatura estándar del ambiente de servicio	-20 / +50°C
Temperatura típica sobre el vidrio	65°C

#### LED Life / Failure Ratio

L70 B10 C0 60500h

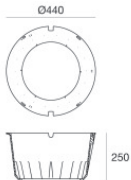

<p><b>L. 1m</b></p> 	<p>Cable y conector</p> <p>Tipología cable power + signal cable allinone; Largo 1000 mm; aislamiento doppio con schermatura per segnale; diámetro externo: 12.6 mm; colores: blanco - azul - rojo - gris - marrón - amarillo-verde.</p>	<p><b>Code</b> <u>98660</u></p>
<p><b>L. 5m</b></p> 	<p>Cable y conector</p> <p>Tipología cable power + signal cable allinone; Largo 5000 mm; aislamiento doppio con schermatura per segnale; diámetro externo: 12.6 mm; colores: blanco - azul - rojo - gris - marrón - amarillo-verde.</p>	<p><b>Code</b> <u>98661</u></p>
<p><b>L. 1m</b></p> 	<p>Cable y conector</p> <p>Tipología cable power + signal cable allinone; Largo 1000 mm; aislamiento doppio con schermatura per segnale; diámetro externo: 12.6 mm.</p>	<p><b>Code</b> <u>98662</u></p>
<p><b>L. 5m</b></p> 	<p>Cable y conector</p> <p>Tipología cable power + signal cable allinone; Largo 5000 mm; aislamiento doppio con schermatura per segnale; diámetro externo: 12.6 mm.</p>	<p><b>Code</b> <u>98663</u></p>
 	<p>Conector - Start splitter</p> <p>Tipología cable power + signal cable allinone; Largo 5000 + 5000 + 200 mm; aislamiento doppio con schermatura per segnale.</p>	<p><b>Code</b> <u>98985</u></p>
 	<p>Conector - Continuity splitter</p> <p>Tipología cable power + signal cable allinone; Largo 200 + 200 + 5000 mm; aislamiento doppio con schermatura per segnale.</p>	<p><b>Code</b> <u>99390</u></p>
	<p>Conector - Adaptador de cierre de línea DMX para cables ALLinONE</p> <p>Tipología cable power + signal cable allinone; ; aislamiento doppio con schermatura per segnale.</p>	<p><b>Code</b> <u>98986</u></p>
 	<p>Caja de empotrar</p> <p>posición de instalación: piso; tipo instalación: albañilería L=440mm, H=250mm, D=440mm.</p> <p>Material:Plástico ABS, color:negro.</p>	<p><b>Code</b> <u>83096</u></p>



Suelo\_RXFJ | Uplights | Accessories  
**82724V50**

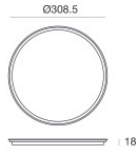

Plantilla

**Code**  
83098

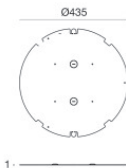

Accesorios para cajas de empotrar - Fondo de caja para carcasa exterior  
Material: Hierro Galvanizado, color: gris, elaboración : Galvanizado.

**Code**  
93099