

Cob40_R

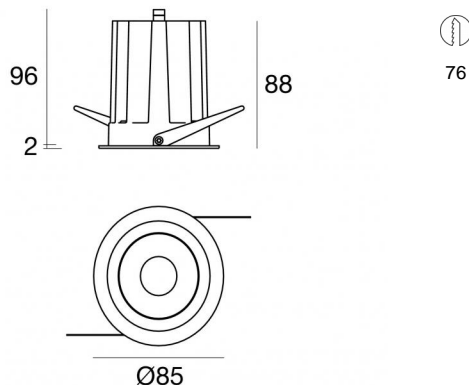

Downlights | 1 arrayLED 18 W DC 500 mA | CRI 90
82473M15





Datos técnicos	
Posición de instalación	Techo
Ambiente de instalación	Interiores
Fuente de luz	LED
Circuit structure	arrayLED
Óptica	Spot
Light emission direction	downward
Potencia nominal	18 W DC
Flujo luminoso (fuente)	2692 lm
Rango de voltaje de entrada	500mA
CCT / Tone	2700 K
Índice de rendimientos cromático	90 Ra
C.C. / C.V.	CC
Clase de aislamiento	3
IP	IP40
IP vano óptico	IP44
IK	IK05
Test del hilo incandescente	850°
Montaje directo sobre superficies normalmente inflamables	Sí
CE	Sí
Driver incluido.	No
Artículo regulable	DALI - 1-10V
Orientabilidad	No
Basculación	No
Practicabilidad	No
Transitabilidad	No
Cable incluido.	Sí
Largo del cable	0.15 m
Resinado	No
Tipología de emisión luminosa	Una emisión
Peso neto	0.375 Kg
Protección descargas electrostáticas	No
Protección contra sobretensiones	No

Acabado cuerpo	
Material	Aluminio fundido EN AB - 46100
Color	Blanco
Elaboración	Recubrimiento en polvo

Electrónica

 99115
1-10V - N/O button Multi Power 198~264V AC / 180~275V DC (1 art.)

 99106
On/Off Driver 198~264V AC (1 art.)

 C-E100001
Push and Simply Dim - DALI-2 Multi Power 198~264V AC / 180~275V DC (1 art.)

Cables Electrificación

Cable connector	MALE JST SMR-02V-B
Cable connector	FEMALE JST SMP-02V-BC



Downlights | 1 arrayLED 18 W DC 500 mA | CRI 90
82473M15

Single emission recessed downlights for indoor application. The super warm white LED light source with a spot light distribution is composed of 1 arrayLEDs with CCT of 2700 K and a CRI 90; the source luminous flux is 2692 lm, with a 149.6 lm/W nominal luminous efficacy.

The device body is made of die-cast aluminium en ab - 46100 and features a white finish, processed by means of powder coating. The ingress protection degree is IP40; the total weight is of 0.375 kg. The power supply driver is not provided and is to be ordered separately.

The total absorbed power is 18 W. The power supply cable is included and features a 0.15 m length.

The device features protection class III and can be ceiling-mounted, with a 76 mm diameter hole (in plasterboard) with an outer casing, code 89374(for concrete or masonry).

Compliant with the EN 60598-1 standard and its specific provisions.

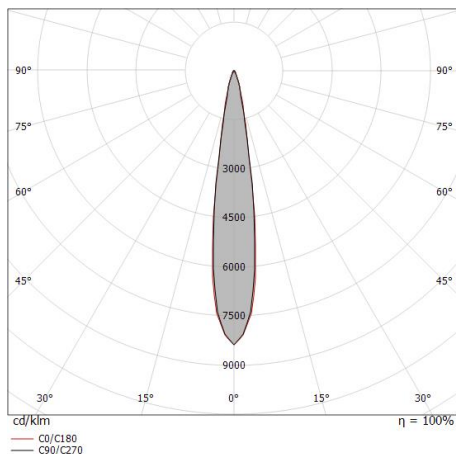

Distance [m]	Cone diameter [m]	illuminance [lx]
0.5	0.14 0.15	E(0°) 71940 E(C90) 8.1° 35132 E(C0) 8.3° 35143
1.0	0.28 0.29	E(0°) 17985 E(C90) 8.1° 8783 E(C0) 8.3° 8786
1.5	0.43 0.44	E(0°) 7993 E(C90) 8.1° 3904 E(C0) 8.3° 3905
2.0	0.57 0.58	E(0°) 4496 E(C90) 8.1° 2196 E(C0) 8.3° 2196
2.5	0.71 0.73	E(0°) 2878 E(C90) 8.1° 1405 E(C0) 8.3° 1406
3.0	0.85 0.88	E(0°) 1998 E(C90) 8.1° 976 E(C0) 8.3° 976

— C0/C180 (Half-peak divergence: 16.6°)
— C90/C270 (Half-peak divergence: 16.2°)

Clase de eficiencia energética

Este producto contiene una fuente de luz de clase de eficiencia energética E.

Características Luminotécnicas

Light Output Ratio (LOR)	79 %
Flujo luminoso (fuente)	2692 lm
Flujo luminoso de luminaria	2147 lm
Consumption	18 W
Rendimiento luminoso de las luminarias	119 lm/W
Temperatura de color	2700 K
Standard Deviation of Colour Matching	2 Step MacAdam
Índice de rendimientos cromático	90 Ra
Colour Rendering Index	60 R9
Black Body Locus	On
Temperatura estándar del ambiente de servicio	-20 / +50°C
Temperatura típica sobre el vidrio	40°C

LED Life / Failure Ratio

L70 B10 C0 252000h (at Tj 65 Ta 25)

UGR

UGR axial	15.6
UGR transversal	15.7
X=4H Y=8H	S=0.25H
Reflection factor	70/50/20

OPTICAL

Óptica C0/C180 16°
Symmetrical





Cob40_R | Downlights | Accessories
82473M15



Caja de empotrar
posición de instalación: techo; tipo instalación: albañilería L=200mm, H=113mm,
D=137mm.
Material:polipropileno, color:blanco.

Code
89373

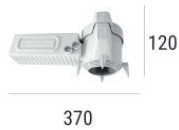

Caja de empotrar
posición de instalación: techo; tipo instalación: albañilería L=370mm, H=120mm,
D=200mm.
Material:polipropileno, color:blanco.

Code
89374

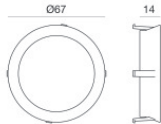

Anillo decorativo blanco

Code
99901

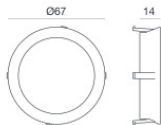

Anillo decorativo en color dorado

Code
99902

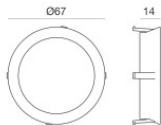

Anillo decorativo en color cobre

Code
99903

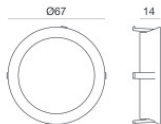

Anillo decorativo cromado

Code
99904