

Pound_Focus

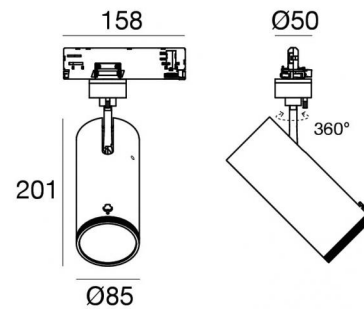

Proyectores | 198-264 V
1 arrayLED 32.5 W DC - 37 W AC | CRI 92
82110W85



Datos técnicos	
Tipo	Carril
Posición de instalación	Techo
Ambiente de instalación	Interiores
Fuente de luz	LED
Circuit structure	arrayLED
Óptica	Adjustable Focus
Light emission direction	frontal
Potencia nominal	32.5 W DC
Poder total	37 W
Flujo luminoso (fuente)	3937 lm
Tensión nominal de entrada	220 - 240 V AC
Rango de voltaje de entrada	198 - 264 V AC
Frequency	50 - 60 Hz
CCT / Tone	3000 K
Índice de rendimientos cromático	92 Ra
C.C. / C.V.	AC
Clase de aislamiento	2
IP	IP20
Test del hilo incandescente	850°
Montaje directo sobre superficies normalmente inflamables	Sí
CE	Sí
Driver incluido.	driver
Artículo regulable	Dimming on Board
Orientabilidad	Orientabile
ángulo total (plano vertical)	90 °
ángulo total (plano horizontal)	360 °
Basculación	No
Practicabilidad	No
Transitabilidad	No
Cable incluido.	No
Resinado	No
Tipología de emisión luminosa	Una emisión
Peso neto	0.92 Kg
Protección descargas electrostáticas	Sí
Protección contra sobretensiones	2 KV

Acabado cuerpo	
Material	Aluminio fundido EN AB - 46100
Color	Negro
Elaboración	Recubrimiento en polvo

Proyectores | 198-264 V | 1 arrayLED 32.5 W DC - 37 W AC | CRI 92 | Ángulo
óptico máximo
82110W85

Single emission projectors for indoor application. The warm white LED light source with a adjustable focus light distribution is composed of 1 arrayed LEDs with CCT of 3000 K and a CRI 92; the source luminous flux is 3937 lm, with a 121.1 lm/W nominal luminous efficacy.

The device body is made of die-cast aluminium en ab - 46100 and features a black finish, processed by means of powder coating. The ingress protection degree is IP20; the total weight is of 0.92 kg.

The total absorbed power is 37 W.

The device features protection class II and can be ceiling-mounted.

Compliant with the EN 60598-1 standard and its specific provisions.

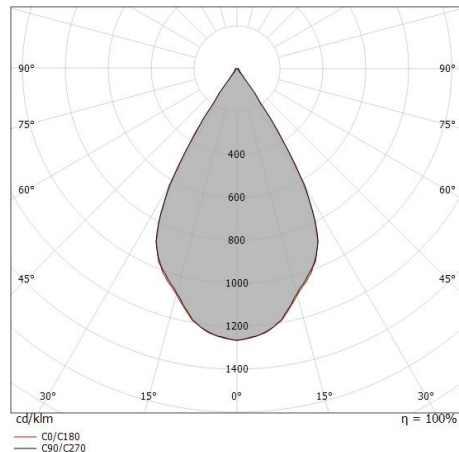

Distance [m]	Cone diameter [m]	illuminance [lx]
0.5	0.58 0.57	E(0°) 11724 E(C90) 29.9° 3833 E(C0) 29.7° 3867
1.0	1.15 1.14	E(0°) 2931 E(C90) 29.9° 958 E(C0) 29.7° 967
1.5	1.73 1.71	E(0°) 1303 E(C90) 29.9° 426 E(C0) 29.7° 430
2.0	2.30 2.28	E(0°) 733 E(C90) 29.9° 240 E(C0) 29.7° 242
2.5	2.88 2.85	E(0°) 469 E(C90) 29.9° 153 E(C0) 29.7° 155
3.0	3.45 3.42	E(0°) 326 E(C90) 29.9° 106 E(C0) 29.7° 107

— C0/C180 (Half-peak divergence: 59.4°)
— C90/C270 (Half-peak divergence: 59.8°)

Clase de eficiencia energética

Este producto contiene una fuente de luz de clase de eficiencia energética F.

Características Luminotécnicas

Light Output Ratio (LOR)	58 %
Flujo luminoso (fuente)	3937 lm
Flujo luminoso de luminaria	2317 lm
Consumption	37 W
Rendimiento luminoso de las luminarias	62 lm/W
Temperatura de color	3000 K
Standard Deviation of Colour Matching	2 Step MacAdam
Índice de rendimientos cromático	92 Ra
Black Body Locus	On
Temperatura estándar del ambiente de servicio	-20 / +50°C
Temperatura típica sobre el vidrio	40°C

LED Life / Failure Ratio

L70 B10 C0 252000h (at Tj 65 Ta 25)

UGR

UGR axial	20.9
UGR transversal	20.8
X=4H Y=8H	S=0.25H
Reflection factor	70/50/20

OPTICAL

Óptica C0/C180	59°
Light distribution simmetry	Symmetrical

COLOR VECTOR GRAPHIC



Proyectores | 198-264 V | 1 arrayLED 32.5 W DC - 37 W AC | CRI 92 | Ángulo

óptico míximo

82110W85

Single emission projectors for indoor application. The warm white LED light source with a adjustable focus light distribution is composed of 1 arrayed LEDs with CCT of 3000 K and a CRI 92; the source luminous flux is 3937 lm, with a 121.1 lm/W nominal luminous efficacy.

The device body is made of die-cast aluminium en ab - 46100 and features a black finish, processed by means of powder coating. The ingress protection degree is IP20; the total weight is of 0.92 kg.

The total absorbed power is 37 W.

The device features protection class II and can be ceiling-mounted.

Compliant with the EN 60598-1 standard and its specific provisions.

Clase de eficiencia energética

Este producto contiene una fuente de luz de clase de eficiencia energética F.

Características Luminotécnicas

Light Output Ratio (LOR)	28 %
Flujo luminoso (fuente)	3937 lm
Flujo luminoso de luminaria	1112 lm
Consumption	37 W
Rendimiento luminoso de las luminarias	30 lm/W
Temperatura de color	3000 K
Standard Deviation of Colour Matching	2 Step MacAdam
Índice de rendimientos cromático	92 Ra
Black Body Locus	On
Temperatura estándar del ambiente de servicio	-20 / +50°C
Temperatura típica sobre el vidrio	40°C

LED Life / Failure Ratio

L70 B10 C0 252000h (at Tj 65 Ta 25)

UGR

UGR axial	11.5
UGR transversal	11.6
X=4H Y=8H	S=0.25H
Reflection factor	70/50/20

OPTICAL

Óptica C0/C180	16°
Light distribution simmetry	Symmetrical

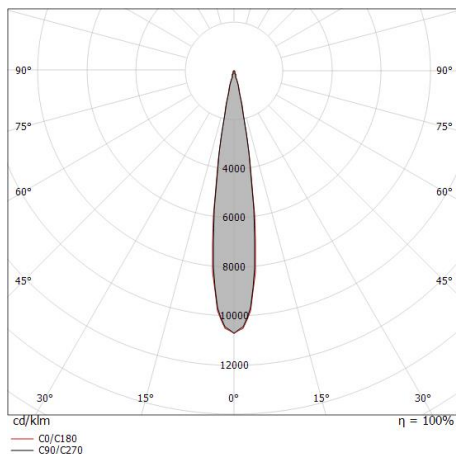

Distance [m]	Cone diameter [m]	illuminance [lx]
0.5	0.15 0.15	E(0°) 47602 E(C90) 8.2° 23573 E(C0) 8.5° 23096
1.0	0.29 0.30	E(0°) 11900 E(C90) 8.2° 5893 E(C0) 8.5° 5774
1.5	0.43 0.45	E(0°) 5289 E(C90) 8.2° 2819 E(C0) 8.5° 2566
2.0	0.58 0.60	E(0°) 2975 E(C90) 8.2° 1473 E(C0) 8.5° 1443
2.5	0.72 0.75	E(0°) 1904 E(C90) 8.2° 943 E(C0) 8.5° 924
3.0	0.86 0.90	E(0°) 1322 E(C90) 8.2° 655 E(C0) 8.5° 642

— C0/C180 (Half-peak divergence: 17.0°)
— C90/C270 (Half-peak divergence: 16.4°)

COLOR VECTOR GRAPHIC

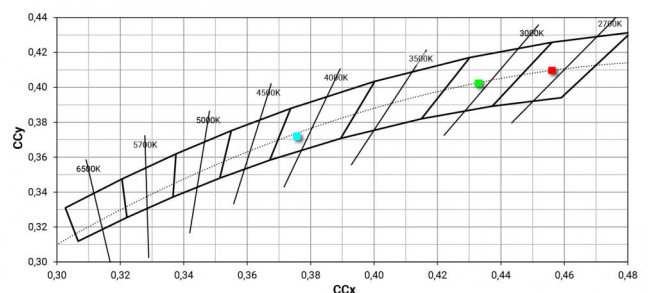
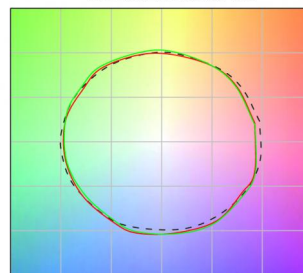

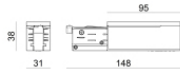

Fuente de alimentación
 Material:PC, color:blanco.

Code
81033

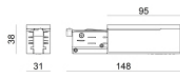

Fuente de alimentación
 Material:PC, color:blanco.

Code
81036



Fuente de alimentación
 Material:PC, color:negro.

Code
81037



Fuente de alimentación
 Material:PC, color:negro.

Code
81034



Tapón
 Material:PC, color:blanco.

Code
80999



Tapón
 Material:PC, color:negro.

Code
81000



Tapón
 Material:PC, color:blanco.

Code
81002



Tapón
 Material:PC, color:negro.

Code
81003



Tapón
Material:blanco.

Code
81084



Tapón
Material:negro, color:negro.

Code
81085



Rosetón
Material:plástico, color:blanco.

Code
81012



Rosetón
Material:plástico, color:negro.

Code
81014



Rosetón
Material:plástico, color:blanco.

Code
81013



Rosetón
Material:plástico, color:negro.

Code
81015



Soporte
L=35mm, H=14mm, D=24mm.
Material:aluminio, color:pulido.

Finish
Anod. Al. **Code**
81086



Soporte
L=180mm, H=24mm, D=26mm.
Material:aluminio, color:Aluminio Anodizado, elaboración :Anodizado.

Finish
Code
81024



Soporte
L=180mm, H=24mm, D=20mm.
Material:aluminio, color:blanco RAL 9010, elaboración :Pintura.

Finish	Code
White	81025



Soporte
L=180mm, H=24mm, D=20mm.
Material:aluminio, color:negro RAL 9005, elaboración :Pintura.

Finish	Code
Black	81026



Soporte
L=35mm, H=14mm, D=24mm.
Material:aluminio, color:blanco, elaboración :Pintura.

Finish	Code
White	81087



Soporte
L=35mm, H=14mm, D=24mm.
Material:aluminio, color:Negro, elaboración :Pintura.

Finish	Code
Black	81088

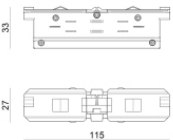

Unión
Tipo lineal.
Material:PC, color:blanco.

Finish	Code
White	81039

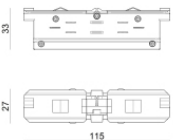

Unión
Tipo lineal.
Material:PC, color:negro.

Finish	Code
Black	81040



Unión
Tipo lineal.
Material:PC, color:blanco.

Finish	Code
White	81042

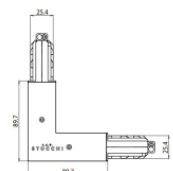

Unión
Tipo lineal.
Material:PC, color:blanco.

Finish	Code
White	81045



		<p>Unión Tipo linear. Material:PC, color:blanco.</p>	<table border="1"> <thead> <tr> <th>Finish</th> <th>Code</th> </tr> </thead> <tbody> <tr> <td>White</td> <td>81048</td> </tr> </tbody> </table>	Finish	Code	White	81048
Finish	Code						
White	81048						
		<p>Unión Tipo flexible curve. Material:PC, color:blanco.</p>	<table border="1"> <thead> <tr> <th>Finish</th> <th>Code</th> </tr> </thead> <tbody> <tr> <td>White</td> <td>81066</td> </tr> </tbody> </table>	Finish	Code	White	81066
Finish	Code						
White	81066						
		<p>Unión Tipo linear. Material:PC, color:blanco.</p>	<table border="1"> <thead> <tr> <th>Finish</th> <th>Code</th> </tr> </thead> <tbody> <tr> <td>White</td> <td>81063</td> </tr> </tbody> </table>	Finish	Code	White	81063
Finish	Code						
White	81063						
		<p>Unión Tipo linear. Material:PC, color:blanco.</p>	<table border="1"> <thead> <tr> <th>Finish</th> <th>Code</th> </tr> </thead> <tbody> <tr> <td>White</td> <td>81051</td> </tr> </tbody> </table>	Finish	Code	White	81051
Finish	Code						
White	81051						
		<p>Unión Tipo linear. Material:PC, color:blanco.</p>	<table border="1"> <thead> <tr> <th>Finish</th> <th>Code</th> </tr> </thead> <tbody> <tr> <td>White</td> <td>81054</td> </tr> </tbody> </table>	Finish	Code	White	81054
Finish	Code						
White	81054						
		<p>Unión Tipo linear. Material:PC, color:blanco.</p>	<table border="1"> <thead> <tr> <th>Finish</th> <th>Code</th> </tr> </thead> <tbody> <tr> <td>White</td> <td>81057</td> </tr> </tbody> </table>	Finish	Code	White	81057
Finish	Code						
White	81057						
		<p>Unión Tipo linear. Material:PC, color:blanco.</p>	<table border="1"> <thead> <tr> <th>Finish</th> <th>Code</th> </tr> </thead> <tbody> <tr> <td>White</td> <td>81060</td> </tr> </tbody> </table>	Finish	Code	White	81060
Finish	Code						
White	81060						
		<p>Unión Tipo linear. Material:PC, color:negro.</p>	<table border="1"> <thead> <tr> <th>Finish</th> <th>Code</th> </tr> </thead> <tbody> <tr> <td>Black</td> <td>81043</td> </tr> </tbody> </table>	Finish	Code	Black	81043
Finish	Code						
Black	81043						



		<p>Unión</p> <p>Tipo linear.</p> <p>Material:PC, color:negro.</p>	<p>Finish</p> <p>Black</p>	<p>Code</p> <p>81046</p>
		<p>Unión</p> <p>Tipo linear.</p> <p>Material:PC, color:negro.</p>	<p>Finish</p> <p>Black</p>	<p>Code</p> <p>81049</p>
		<p>Unión</p> <p>Tipo flexible curve.</p> <p>Material:PC, color:negro.</p>	<p>Finish</p> <p>Black</p>	<p>Code</p> <p>81067</p>
		<p>Unión</p> <p>Tipo linear.</p> <p>Material:PC, color:negro.</p>	<p>Finish</p> <p>Black</p>	<p>Code</p> <p>81064</p>
		<p>Unión</p> <p>Tipo linear.</p> <p>Material:PC, color:negro.</p>	<p>Finish</p> <p>Black</p>	<p>Code</p> <p>81052</p>
		<p>Unión</p> <p>Tipo linear.</p> <p>Material:PC, color:negro.</p>	<p>Finish</p> <p>Black</p>	<p>Code</p> <p>81055</p>
		<p>Unión</p> <p>Tipo linear.</p> <p>Material:PC, color:negro.</p>	<p>Finish</p> <p>Black</p>	<p>Code</p> <p>81058</p>
		<p>Unión</p> <p>Tipo linear.</p> <p>Material:PC, color:negro.</p>	<p>Finish</p> <p>Black</p>	<p>Code</p> <p>81061</p>



Colgantes
Material:plástico, color:blanco.

Code
81006



Colgantes
Material:plástico, color:blanco.

Code
81007

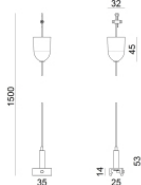

Colgantes
Material:plástico, color:negro.

Code
81008

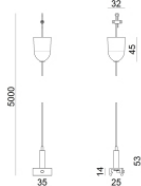

Colgantes
Material:plástico, color:negro.

Code
81009



Colgantes
Material:plástico, color:blanco.

Code
81018



Colgantes
Material:plástico, color:negro.

Code
81019



Colgantes
Material:plástico, color:blanco.

Code
81021



Colgantes
Material:plástico, color:negro.

Code
81022



		Cubierta de alambre Material:PC, color:blanco.	Code <u>81069</u>
		Cubierta de alambre Material:PC, color:blanco.	Code <u>81072</u>
		Cubierta de alambre Material:PC, color:blanco.	Code <u>81075</u>
		Cubierta de alambre Material:PC, color:blanco.	Code <u>81078</u>
		Cubierta de alambre Material:PC, color:blanco.	Code <u>81081</u>
		Cubierta de alambre Material:PC, color:negro.	Code <u>81070</u>
		Cubierta de alambre Material:PC, color:negro.	Code <u>81073</u>
		Cubierta de alambre Material:PC, color:negro.	Code <u>81076</u>



		<p>Cubierta de alambre Material:PC, color:negro.</p>	<p>Code <u>81079</u></p>
		<p>Cubierta de alambre Material:PC, color:negro.</p>	<p>Code <u>81082</u></p>
		<p>Cubierta de alambre Material:blanco.</p>	<p>Code <u>83249</u></p>
		<p>Cubierta de alambre Material:negro, color:negro.</p>	<p>Code <u>83250</u></p>
			<p>Code <u>81094</u></p>
			<p>Code <u>81091</u></p>
			<p>Code <u>81095</u></p>
			<p>Code <u>81093</u></p>



	Herramienta	Code	
		81005	
		Carril Largo: 1000mm; Tipo carril: Standard. Material:aluminio, color:Blanco, elaboración :Pintura.	Finish Code White 80990
		Carril Largo: 2000mm; Tipo carril: Standard. Material:aluminio, color:Blanco, elaboración :Pintura.	Finish Code White 80991
		Carril Largo: 3000mm; Tipo carril: Standard. Material:aluminio, color:Blanco, elaboración :Pintura.	Finish Code White 80992
		Carril Largo: 1000mm; Tipo carril: Standard. Material:aluminio, color:Negro, elaboración :Pintura.	Finish Code Black 80993
		Carril Largo: 2000mm; Tipo carril: Standard. Material:aluminio, color:Negro, elaboración :Pintura.	Finish Code Black 80994
		Carril Largo: 3000mm; Tipo carril: Standard. Material:aluminio, color:Negro, elaboración :Pintura.	Finish Code Black 80995
		Carril Largo: 1000mm; Tipo carril: Standard. Material:aluminio, color:Blanco, elaboración :Pintura.	Finish Code White 83336

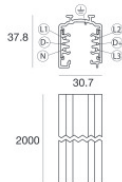

Carril

Largo: 2000mm; Tipo carril: Standard.

Material:aluminio, color:Blanco, elaboración :Pintura.

Finish

White

Code

83337

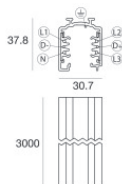

Carril

Largo: 3000mm; Tipo carril: Standard.

Material:aluminio, color:Blanco, elaboración :Pintura.

Finish

White

Code

83338

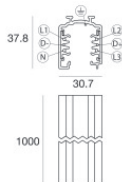

Carril

Largo: 1000mm; Tipo carril: Standard.

Material:aluminio, color:Negro, elaboración :Pintura.

Finish

Black

Code

83339

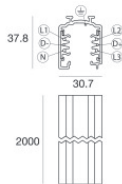

Carril

Largo: 2000mm; Tipo carril: Standard.

Material:aluminio, color:Negro, elaboración :Pintura.

Finish

Black

Code

83340

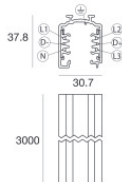
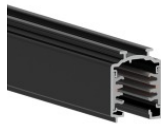

Carril

Largo: 3000mm; Tipo carril: Standard.

Material:aluminio, color:Negro, elaboración :Pintura.

Finish

Black

Code

83341