

# Pound\_Focus

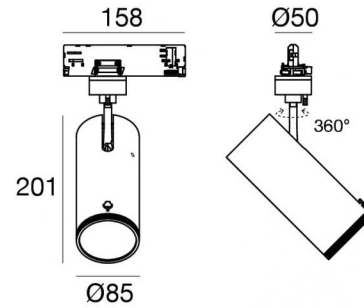

Proyectores | 198-264 V  
1 arrayLED 32.5 W DC - 37 W AC | CRI 92  
**82110N85**



Datos técnicos	
Tipo	Carril
Posición de instalación	Techo
Ambiente de instalación	Interiores
Fuente de luz	LED
Circuit structure	arrayLED
Óptica	Adjustable Focus
Light emission direction	frontal
Potencia nominal	32.5 W DC
Poder total	37 W
Flujo luminoso (fuente)	4232 lm
Tensión nominal de entrada	220 - 240 V AC
Rango de voltaje de entrada	198 - 264 V AC
Frequency	50 - 60 Hz
CCT / Tone	4000 K
Índice de rendimientos cromático	92 Ra
C.C. / C.V.	AC
Clase de aislamiento	2
IP	IP20
Test del hilo incandescente	850°
Montaje directo sobre superficies normalmente inflamables	Sí
CE	Sí
Driver incluido.	driver
Artículo regulable	Dimming on Board
Orientabilidad	Orientabile
ángulo total (plano vertical)	90 °
ángulo total (plano horizontal)	360 °
Basculación	No
Practicabilidad	No
Transitabilidad	No
Cable incluido.	No
Resinado	No
Tipología de emisión luminosa	Una emisión
Peso neto	0.92 Kg
Protección descargas electrostáticas	Sí
Protección contra sobretensiones	2 KV

Acabado cuerpo	
Material	Aluminio fundido EN AB - 46100
Color	Negro
Elaboración	Recubrimiento en polvo

Proyectores | 198-264 V | 1 arrayLED 32.5 W DC - 37 W AC | CRI 92 | Ángulo  
óptico máximo  
**82110N85**

Single emission projectors for indoor application. The natural white LED light source with a adjustable focus light distribution is composed of 1 arrayed LEDs with CCT of 4000 K and a CRI 92; the source luminous flux is 4232 lm, with a 130.2 lm/W nominal luminous efficacy.

The device body is made of die-cast aluminium en ab - 46100 and features a black finish, processed by means of powder coating. The ingress protection degree is IP20; the total weight is of 0.92 kg.

The total absorbed power is 37 W.

The device features protection class II and can be ceiling-mounted.

Compliant with the EN 60598-1 standard and its specific provisions.

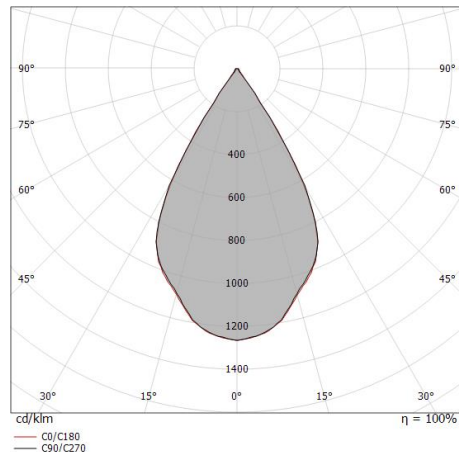

Distance [m]	Cone diameter [m]	illuminance [lx]
0.5	0.58 0.57	E(0°) 12602 E(C90) 4120 E(C0) 4157
1.0	1.15 1.14	E(0°) 3151 E(C90) 1030 E(C0) 1039
1.5	1.73 1.71	E(0°) 1400 E(C90) 458 E(C0) 462
2.0	2.30 2.28	E(0°) 788 E(C90) 258 E(C0) 260
2.5	2.88 2.85	E(0°) 504 E(C90) 165 E(C0) 166
3.0	3.45 3.42	E(0°) 350 E(C90) 114 E(C0) 115

— C0/C180 (Half-peak divergence: 59.4°)  
— C90/C270 (Half-peak divergence: 59.8°)

### Clase de eficiencia energética

Este producto contiene una fuente de luz de clase de eficiencia energética E.

### Características Luminotécnicas

Light Output Ratio (LOR)	58 %
Flujo luminoso (fuente)	4232 lm
Flujo luminoso de luminaria	2491 lm
Consumption	37 W
Rendimiento luminoso de las luminarias	67 lm/W
Temperatura de color	4000 K
Standard Deviation of Colour Matching	2 Step MacAdam
Índice de rendimientos cromático	92 Ra
Black Body Locus	On
Temperatura estándar del ambiente de servicio	-20 / +50°C
Temperatura típica sobre el vidrio	40°C

### LED Life / Failure Ratio

L70 B10 C0 252000h (at Tj 65 Ta 25)

### UGR

UGR axial	21.2
UGR transversal	21
X=4H   Y=8H	S=0.25H
Reflection factor	70/50/20

### OPTICAL

Óptica C0/C180	59°
Light distribution simmetry	Symmetrical

### COLOR VECTOR GRAPHIC



Proyectores | 198-264 V | 1 arrayLED 32.5 W DC - 37 W AC | CRI 92 | &Aacute;ngulo

&oacute;ptico m&iacute;ximo

## 82110N85

Single emission projectors for indoor application. The natural white LED light source with a adjustable focus light distribution is composed of 1 arrayed LEDs with CCT of 4000 K and a CRI 92; the source luminous flux is 4232 lm, with a 130.2 lm/W nominal luminous efficacy.

The device body is made of die-cast aluminium en ab - 46100 and features a black finish, processed by means of powder coating. The ingress protection degree is IP20; the total weight is of 0.92 kg.

The total absorbed power is 37 W.

The device features protection class II and can be ceiling-mounted.

Compliant with the EN 60598-1 standard and its specific provisions.

### Clase de eficiencia energética

Este producto contiene una fuente de luz de clase de eficiencia energética E.

### Características Luminotécnicas

Light Output Ratio (LOR)	28 %
Flujo luminoso (fuente)	4232 lm
Flujo luminoso de luminaria	1195 lm
Consumption	37 W
Rendimiento luminoso de las luminarias	32 lm/W
Temperatura de color	4000 K
Standard Deviation of Colour Matching	2 Step MacAdam
Índice de rendimientos cromático	92 Ra
Black Body Locus	On
Temperatura estándar del ambiente de servicio	-20 / +50°C
Temperatura típica sobre el vidrio	40°C

### LED Life / Failure Ratio

L70 B10 C0 252000h (at Tj 65 Ta 25 )

### UGR

UGR axial	11.8
UGR transversal	11.8
X=4H   Y=8H	S=0.25H
Reflection factor	70/50/20

### OPTICAL

Óptica C0/C180	16°
Light distribution simmetry	Symmetrical

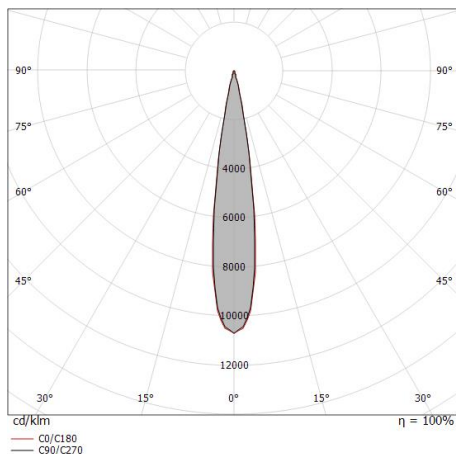

Distance [m]	Cone diameter [m]	illuminance [lx]
0.5	0.15 0.15	E(0°) 51164 E(C90) 8.2° 25337 E(C0) 8.5° 24825
1.0	0.29 0.30	E(0°) 12791 E(C90) 8.2° 6334 E(C0) 8.5° 6206
1.5	0.43 0.45	E(0°) 5685 E(C90) 8.2° 2815 E(C0) 8.5° 2758
2.0	0.58 0.60	E(0°) 3198 E(C90) 8.2° 1584 E(C0) 8.5° 1552
2.5	0.72 0.75	E(0°) 2047 E(C90) 8.2° 1013 E(C0) 8.5° 993
3.0	0.86 0.90	E(0°) 1421 E(C90) 8.2° 704 E(C0) 8.5° 690

— C0/C180 (Half-peak divergence: 17.0°)  
— C90/C270 (Half-peak divergence: 16.4°)

### COLOR VECTOR GRAPHIC

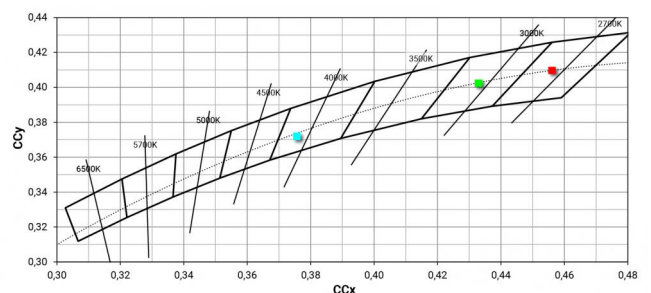
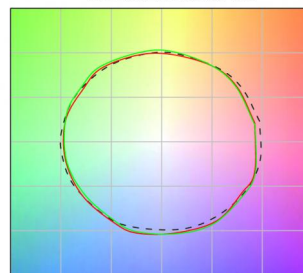

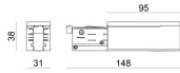

Fuente de alimentación  
Material:PC, color:blanco.

**Code**  
81033

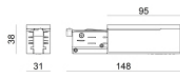

Fuente de alimentación  
Material:PC, color:blanco.

**Code**  
81036

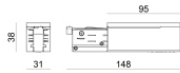

Fuente de alimentación  
Material:PC, color:negro.

**Code**  
81037

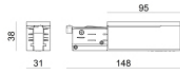

Fuente de alimentación  
Material:PC, color:negro.

**Code**  
81034



Tapón  
Material:PC, color:blanco.

**Code**  
80999



Tapón  
Material:PC, color:negro.

**Code**  
81000



Tapón  
Material:PC, color:blanco.

**Code**  
81002



Tapón  
Material:PC, color:negro.

**Code**  
81003



Tapón  
Material:blanco.

**Code**  
81084



Tapón  
Material:negro, color:negro.

**Code**  
81085



Rosetón  
Material:plástico, color:blanco.

**Code**  
81012



Rosetón  
Material:plástico, color:negro.

**Code**  
81014



Rosetón  
Material:plástico, color:blanco.

**Code**  
81013



Rosetón  
Material:plástico, color:negro.

**Code**  
81015



Soporte  
L=35mm, H=14mm, D=24mm.  
Material:aluminio, color:pulido.

**Finish** **Code**  
Anod. Al. 81086



Soporte  
L=180mm, H=24mm, D=26mm.  
Material:aluminio, color:Aluminio Anodizado, elaboración :Anodizado.

**Finish** **Code**  
81024



**Soporte**  
L=180mm, H=24mm, D=20mm.  
Material:aluminio, color:blanco RAL 9010, elaboración :Pintura.

Finish	Code
White	81025



**Soporte**  
L=180mm, H=24mm, D=20mm.  
Material:aluminio, color:negro RAL 9005, elaboración :Pintura.

Finish	Code
Black	81026



**Soporte**  
L=35mm, H=14mm, D=24mm.  
Material:aluminio, color:blanco, elaboración :Pintura.

Finish	Code
White	81087



**Soporte**  
L=35mm, H=14mm, D=24mm.  
Material:aluminio, color:Negro, elaboración :Pintura.

Finish	Code
Black	81088

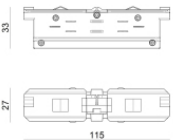

**Unión**  
Tipo lineal.  
Material:PC, color:blanco.

Finish	Code
White	81039

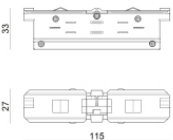

**Unión**  
Tipo lineal.  
Material:PC, color:negro.

Finish	Code
Black	81040



**Unión**  
Tipo lineal.  
Material:PC, color:blanco.

Finish	Code
White	81042

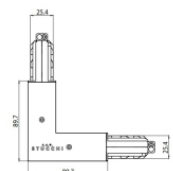

**Unión**  
Tipo lineal.  
Material:PC, color:blanco.

Finish	Code
White	81045



		<p>Unión Tipo linear. Material:PC, color:blanco.</p>	<p><b>Finish</b> White</p>	<p><b>Code</b> 81048</p>
		<p>Unión Tipo flexible curve. Material:PC, color:blanco.</p>	<p><b>Finish</b> White</p>	<p><b>Code</b> 81066</p>
		<p>Unión Tipo linear. Material:PC, color:blanco.</p>	<p><b>Finish</b> White</p>	<p><b>Code</b> 81063</p>
		<p>Unión Tipo linear. Material:PC, color:blanco.</p>	<p><b>Finish</b> White</p>	<p><b>Code</b> 81051</p>
		<p>Unión Tipo linear. Material:PC, color:blanco.</p>	<p><b>Finish</b> White</p>	<p><b>Code</b> 81054</p>
		<p>Unión Tipo linear. Material:PC, color:blanco.</p>	<p><b>Finish</b> White</p>	<p><b>Code</b> 81057</p>
		<p>Unión Tipo linear. Material:PC, color:blanco.</p>	<p><b>Finish</b> White</p>	<p><b>Code</b> 81060</p>
		<p>Unión Tipo linear. Material:PC, color:negro.</p>	<p><b>Finish</b> Black</p>	<p><b>Code</b> 81043</p>



		<p>Unión</p> <p>Tipo linear.</p> <p>Material:PC, color:negro.</p>	<p><b>Finish</b></p> <p>Black</p>	<p><b>Code</b></p> <p>81046</p>
		<p>Unión</p> <p>Tipo linear.</p> <p>Material:PC, color:negro.</p>	<p><b>Finish</b></p> <p>Black</p>	<p><b>Code</b></p> <p>81049</p>
		<p>Unión</p> <p>Tipo flexible curve.</p> <p>Material:PC, color:negro.</p>	<p><b>Finish</b></p> <p>Black</p>	<p><b>Code</b></p> <p>81067</p>
		<p>Unión</p> <p>Tipo linear.</p> <p>Material:PC, color:negro.</p>	<p><b>Finish</b></p> <p>Black</p>	<p><b>Code</b></p> <p>81064</p>
		<p>Unión</p> <p>Tipo linear.</p> <p>Material:PC, color:negro.</p>	<p><b>Finish</b></p> <p>Black</p>	<p><b>Code</b></p> <p>81052</p>
		<p>Unión</p> <p>Tipo linear.</p> <p>Material:PC, color:negro.</p>	<p><b>Finish</b></p> <p>Black</p>	<p><b>Code</b></p> <p>81055</p>
		<p>Unión</p> <p>Tipo linear.</p> <p>Material:PC, color:negro.</p>	<p><b>Finish</b></p> <p>Black</p>	<p><b>Code</b></p> <p>81058</p>
		<p>Unión</p> <p>Tipo linear.</p> <p>Material:PC, color:negro.</p>	<p><b>Finish</b></p> <p>Black</p>	<p><b>Code</b></p> <p>81061</p>





Colgantes  
Material:plástico, color:blanco.

**Code**  
81006



Colgantes  
Material:plástico, color:blanco.

**Code**  
81007

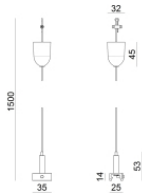

Colgantes  
Material:plástico, color:negro.

**Code**  
81008

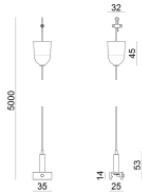

Colgantes  
Material:plástico, color:negro.

**Code**  
81009



Colgantes  
Material:plástico, color:blanco.

**Code**  
81018



Colgantes  
Material:plástico, color:negro.

**Code**  
81019



Colgantes  
Material:plástico, color:blanco.

**Code**  
81021



Colgantes  
Material:plástico, color:negro.

**Code**  
81022



		<p>Cubierta de alambre Material:PC, color:blanco.</p>	<p><b>Code</b> <u>81069</u></p>
		<p>Cubierta de alambre Material:PC, color:blanco.</p>	<p><b>Code</b> <u>81072</u></p>
		<p>Cubierta de alambre Material:PC, color:blanco.</p>	<p><b>Code</b> <u>81075</u></p>
		<p>Cubierta de alambre Material:PC, color:blanco.</p>	<p><b>Code</b> <u>81078</u></p>
		<p>Cubierta de alambre Material:PC, color:blanco.</p>	<p><b>Code</b> <u>81081</u></p>
		<p>Cubierta de alambre Material:PC, color:negro.</p>	<p><b>Code</b> <u>81070</u></p>
		<p>Cubierta de alambre Material:PC, color:negro.</p>	<p><b>Code</b> <u>81073</u></p>
		<p>Cubierta de alambre Material:PC, color:negro.</p>	<p><b>Code</b> <u>81076</u></p>



		<p>Cubierta de alambre Material:PC, color:negro.</p>	<p><b>Code</b> <u>81079</u></p>
		<p>Cubierta de alambre Material:PC, color:negro.</p>	<p><b>Code</b> <u>81082</u></p>
		<p>Cubierta de alambre Material:blanco.</p>	<p><b>Code</b> <u>83249</u></p>
		<p>Cubierta de alambre Material:negro, color:negro.</p>	<p><b>Code</b> <u>83250</u></p>
			<p><b>Code</b> <u>81094</u></p>
			<p><b>Code</b> <u>81091</u></p>
			<p><b>Code</b> <u>81095</u></p>
			<p><b>Code</b> <u>81093</u></p>



	Herramienta	Code	
		81005	
		Carril Largo: 1000mm; Tipo carril: Standard. Material:aluminio, color:Blanco, elaboración :Pintura.	Finish White Code 80990
		Carril Largo: 2000mm; Tipo carril: Standard. Material:aluminio, color:Blanco, elaboración :Pintura.	Finish White Code 80991
		Carril Largo: 3000mm; Tipo carril: Standard. Material:aluminio, color:Blanco, elaboración :Pintura.	Finish White Code 80992
		Carril Largo: 1000mm; Tipo carril: Standard. Material:aluminio, color:Negro, elaboración :Pintura.	Finish Black Code 80993
		Carril Largo: 2000mm; Tipo carril: Standard. Material:aluminio, color:Negro, elaboración :Pintura.	Finish Black Code 80994
		Carril Largo: 3000mm; Tipo carril: Standard. Material:aluminio, color:Negro, elaboración :Pintura.	Finish Black Code 80995
		Carril Largo: 1000mm; Tipo carril: Standard. Material:aluminio, color:Blanco, elaboración :Pintura.	Finish White Code 83336

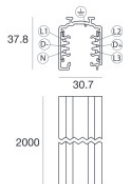

Carril

Largo: 2000mm; Tipo carril: Standard.

Material:aluminio, color:Blanco, elaboración :Pintura.

**Finish**

White

**Code**

83337

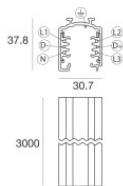

Carril

Largo: 3000mm; Tipo carril: Standard.

Material:aluminio, color:Blanco, elaboración :Pintura.

**Finish**

White

**Code**

83338

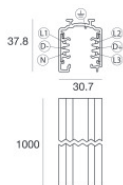

Carril

Largo: 1000mm; Tipo carril: Standard.

Material:aluminio, color:Negro, elaboración :Pintura.

**Finish**

Black

**Code**

83339

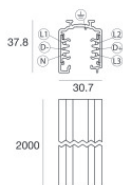

Carril

Largo: 2000mm; Tipo carril: Standard.

Material:aluminio, color:Negro, elaboración :Pintura.

**Finish**

Black

**Code**

83340

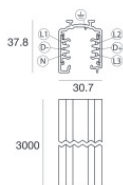

Carril

Largo: 3000mm; Tipo carril: Standard.

Material:aluminio, color:Negro, elaboración :Pintura.

**Finish**

Black

**Code**

83341