

Pound_Wall

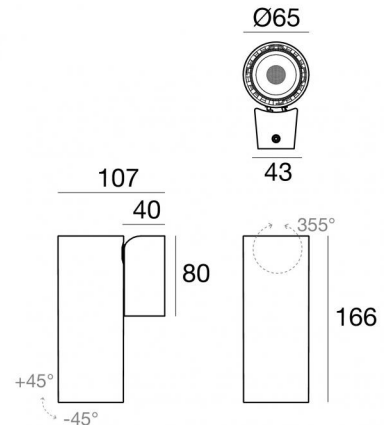

Luminaria de pared | 100-264 V | 1 arrayLED 17.5 W DC - 19.5 W AC | CRI 90
81997W30



Datos técnicos	
Tipo	Superficie
Posición de instalación	Pared
Ambiente de instalación	Interiores
Fuente de luz	LED
Circuit structure	arrayLED
Óptica	Medium Flood
Light emission direction	downward
Potencia nominal	17.5 W DC
Poder total	19.5 W
Flujo luminoso (fuente)	2818 lm
Tensión nominal de entrada	220 - 240 V AC
Rango de voltaje de entrada	100 - 264 V AC
Frequency	50 - 60 Hz
CCT / Tone	3000 K
Índice de rendimientos cromático	90 Ra
C.C. / C.V.	AC
Clase de aislamiento	1
IP	IP20
Test del hilo incandescente	850°
Montaje directo sobre superficies normalmente inflamables	Sí
CE	Sí
Driver incluido.	driver
Artículo regulable	No
Orientabilidad	Orientabile
ángulo total (plano vertical)	90 °
ángulo total (plano horizontal)	355 °
Basculación	No
Practicabilidad	No
Transitabilidad	No
Cable incluido.	No
Resinado	No
Tipología de emisión luminosa	Una emisión
Peso neto	0.8 Kg
Protección descargas electrostáticas	Sí
Protección contra sobretensiones	1.85 KV
Tecnología óptica	Anti - Glare

Acabado cuerpo	
Material	Aluminio fundido EN AB - 46100
Color	Blanco
Elaboración	Recubrimiento en polvo



Luminaria de pared | 100-264 V | 1 arrayLED 17.5 W DC - 19.5 W AC | CRI 90
81997W30

Single emission wall lights for indoor application. The warm white LED light source with a medium flood light distribution is composed of 1 arrayed LEDs with CCT of 3000 K and a CRI 90; the source luminous flux is 2818 lm, with a 161.0 lm/W nominal luminous efficacy.

The device body is made of die-cast aluminium en ab - 46100 and features a white finish, processed by means of powder coating. The ingress protection degree is IP20; the total weight is of 0.8 kg.

The total absorbed power is 19.5 W.

The device features protection class I and can be wall lights-mounted.

Compliant with the EN 60598-1 standard and its specific provisions.

Clase de eficiencia energética

Este producto contiene una fuente de luz de clase de eficiencia energética E.

Características Luminotécnicas

Flujo luminoso (fuente)	2818 lm
Temperatura de color	3000 K
Standard Deviation of Colour Matching	2 Step MacAdam
Índice de rendimientos cromático	90 Ra
Colour Rendering Index	60 R9
Black Body Locus	On
Temperatura estándar del ambiente de servicio	-20 / +50°C
Temperatura típica sobre el vidrio	40°C

LED Life / Failure Ratio

L70 B10 C0 252000h (at Tj 65 Ta 25)

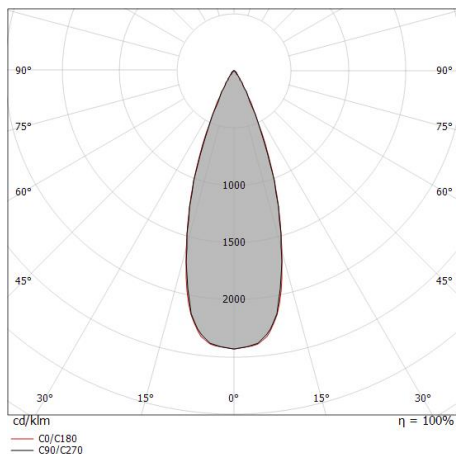





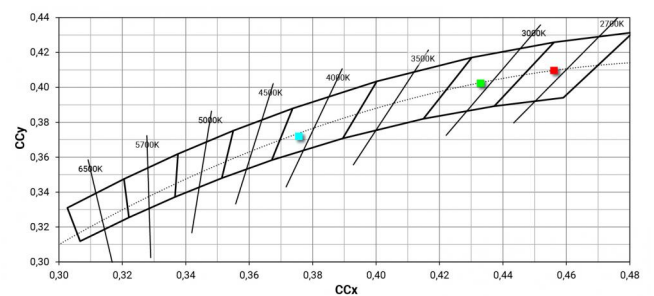

Distance [m]	Cone diameter [m]	illuminance [lx]
0.5	0.33	E(0°) 15389 E(C90) 18.3° 6597 E(C0) 18.4° 6624
1.0	0.66	E(0°) 3847 E(C90) 18.3° 1649 E(C0) 18.4° 1656
1.5	0.99	E(0°) 1710 E(C90) 18.3° 733 E(C0) 18.4° 736
2.0	1.32	E(0°) 962 E(C90) 18.3° 412 E(C0) 18.4° 414
2.5	1.65	E(0°) 616 E(C90) 18.3° 264 E(C0) 18.4° 265
3.0	1.98	E(0°) 427 E(C90) 18.3° 183 E(C0) 18.4° 184

— C0/C180 (Half-peak divergence: 36.8°)
 — C90/C270 (Half-peak divergence: 36.6°)

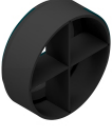



	<p>Difusor Tipo de difusor: filtro elíptico. Material:Pom-C, color:Negro.</p>	<p>Code <u>99781</u></p>
	<p>antideslumbramiento Tipo antideslumbrante: louvre de nido de abeja. Material:Pom-C, color:Negro.</p>	<p>Code <u>99780</u></p>
	<p>antideslumbramiento Tipo antideslumbrante: frangiluce a croce. Material:Pom-C, color:Negro.</p>	<p>Code <u>99779</u></p>
	<p>antideslumbramiento Tipo antideslumbrante: schermo cilindrico 45°. Material:Pom-C, color:Negro.</p>	<p>Code <u>99782</u></p>
	<p>Óptica Distribución de la luz: spot,Material de revestimiento: policarbonato resistente a los rayos uv</p>	<p>Code <u>99827</u></p>
	<p>Óptica Distribución de la luz: medium flood,Material de revestimiento: ,policarbonato resistente a los rayos uv,policarbonato resistente a los rayos uv,policarbonato resistente a los rayos uv</p>	<p>Code <u>99828</u></p>
	<p>Óptica Distribución de la luz: flood,Material de revestimiento: ,policarbonato resistente a los rayos uv,policarbonato resistente a los rayos uv,policarbonato resistente a los rayos uv</p>	<p>Code <u>99829</u></p>