

Prolamp RGBW

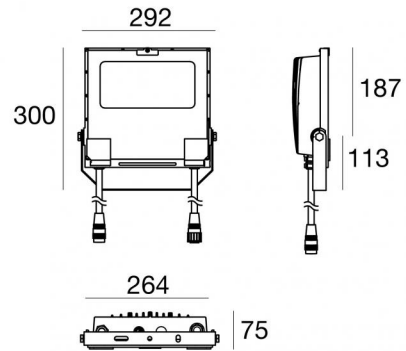

Proyectores | 8 x powerLEDs 59 W DC 48 V
RGBW - 3000
81949V25



Datos técnicos	
Tipo	Superficie
Posición de instalación	Pared - Techo - Piso
Ambiente de instalación	Exteriores
Fuente de luz	LED
Circuit structure	powerLEDs
Óptica	Elíptico
Light emission direction	frontal
Potencia nominal	59 W DC
CCT / Tone	RGBW - 3000 K
C.C. / C.V.	CV
Clase de aislamiento	3
IP	IP67
IK	IK08
Test del hilo incandescente	850°
Montaje directo sobre superficies normalmente inflamables	Sí
CE	Sí
Driver incluido.	Control unit
Artículo regulable	DMX-RDM
Orientabilidad	Orientabile
ángulo total (plano vertical)	180 °
Basculación	No
Practicabilidad	No
Transitabilidad	No
Cable incluido.	Sí
Largo del cable	0.3 m
Resinado	No
Tipología de emisión luminosa	Una emisión
Peso neto	3.8 Kg
Protección descargas electrostáticas	Sí
Protección contra sobretensiones	4 KV
Características tecnológicas del producto	TCS

Acabado cuerpo

Material	Aluminio fundido EN AB - 46100
Color	Negro
Elaboración	Anodizado de poro abierto + pintado con polvo

Acabado difusor

Material	Vidrio extra claro - templado
Color	transparente
Elaboración	Serigrafía

Acabado abrazadera

Material	Acero AISI 304
Color	acero

Electrónica

	99785 On/Off Driver 100~305V AC / 142~431V DC 240 W (- art.)
---	---

	C-E700026 DMX Controller (- art.)
---	--------------------------------------

Cables Electrification+signal

IP (locked condition)	67
Cable connector	AllinONE Male Plug 6 Pin
Cable connector	ALLinONE Female Socket 6 Pin

Lumen RGBW

N. Led	Rojo	Verde	Azul	blanco
8	592 lm	968 lm	168 lm	976 lm

Prolamp RGBW



Proyectores | 8 x powerLEDs 59 W DC 48 V | RGBW - 3000
81949V25

Single emission projectors for outdoor application. The RGBW - 3000 K LED light source with a elliptic light distribution is composed of 8 powerled LEDs with CCT of RGB-W 3000 K.

The device body is made of die-cast aluminium en ab - 46100 and features a black finish, processed by means of open pore anodizing + powder coating; the diffuser is made of extra clear glass - tempered with a silk-screening treatment. The ingress protection degree is IP67; the total weight is of 3.8 kg.

The total absorbed power is 59 W. The power supply cable is included and features a 0.3 m length.

The device features protection class III and can be wall lights, ceiling or floor-mounted.

Compliant with the EN 60598-1 standard and its specific provisions.

Clase de eficiencia energética

Este producto contiene una fuente de luz de clase de eficiencia energética G.









Temperatura estándar del ambiente de servicio	-20 / +50°C
---	-------------

Temperatura típica sobre el vidrio	40°C
------------------------------------	------

LED Life / Failure Ratio

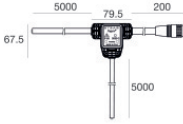
L70 B10 C0 202460h (at Tj 60 Ta 25)



<p>L. 1m</p> 	<p>Cable y conector</p> <p>Tipología cable power + signal cable allinone; Largo 1000 mm; aislamiento doppio con schermatura per segnale; diámetro externo: 12.6 mm; colores: blanco - azul - rojo - gris - marrón - amarillo-verde.</p>	<p>Code <u>98660</u></p>
<p>L. 5m</p> 	<p>Cable y conector</p> <p>Tipología cable power + signal cable allinone; Largo 5000 mm; aislamiento doppio con schermatura per segnale; diámetro externo: 12.6 mm; colores: blanco - azul - rojo - gris - marrón - amarillo-verde.</p>	<p>Code <u>98661</u></p>
<p>L. 1m</p> 	<p>Cable y conector</p> <p>Tipología cable power + signal cable allinone; Largo 1000 mm; aislamiento doppio con schermatura per segnale; diámetro externo: 12.6 mm.</p>	<p>Code <u>98662</u></p>
<p>L. 5m</p> 	<p>Cable y conector</p> <p>Tipología cable power + signal cable allinone; Largo 5000 mm; aislamiento doppio con schermatura per segnale; diámetro externo: 12.6 mm.</p>	<p>Code <u>98663</u></p>
 	<p>Conector - Start splitter</p> <p>Tipología cable power + signal cable allinone; Largo 5000 + 5000 + 200 mm; aislamiento doppio con schermatura per segnale.</p>	<p>Code <u>98985</u></p>
 	<p>Conector - Continuity splitter</p> <p>Tipología cable power + signal cable allinone; Largo 200 + 200 + 5000 mm; aislamiento doppio con schermatura per segnale.</p>	<p>Code <u>99390</u></p>
	<p>Conector - Adaptador de cierre de línea DMX para cables ALLinONE</p> <p>Tipología cable power + signal cable allinone; ; aislamiento doppio con schermatura per segnale.</p>	<p>Code <u>98986</u></p>