

# Quantum\_R EVO

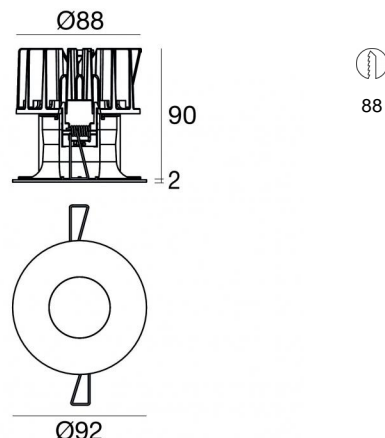

Downlights | 1 arrayLED 9 W DC 700 mA | CRI 90  
77328W10



Datos técnicos	
Posición de instalación	Techo
Ambiente de instalación	Interiores
Fuente de luz	LED
Circuit structure	arrayLED
Óptica	Spot
Light emission direction	internal
Potencia nominal	9 W DC
Flujo luminoso (fuente)	1119 lm
Rango de voltaje de entrada	700mA
CCT / Tone	3000 K
Índice de rendimientos cromático	90 Ra
C.C. / C.V.	CC
Clase de aislamiento	3
IP	IP40
IP vano óptico	IP65
Test del hilo incandescente	850°
Montaje directo sobre superficies normalmente inflamables	Sí
CE	Sí
Driver incluido.	No
Artículo regulable	DALI - 1-10V
Orientabilidad	No
Basculación	No
Practicabilidad	No
Transitabilidad	No
Cable incluido.	Sí
Largo del cable	0.2 m
Resinado	No
Tipología de emisión luminosa	Una emisión
Peso neto	0.3 Kg
Protección descargas electrostáticas	No
Protección contra sobretensiones	No

## Acabado cuerpo

Material	Tecnopolímero
Color	blanco RAL 9003

## Acabado difusor

Material	Policarbonato resistente a los rayos UV
Color	transparente

## Acabado radiador

Material	Aluminio fundido EN AB - 46100
Color	aluminio
Elaboración	Pulido

## Electrónica

- 
99147  
On/Off Driver 198~264V AC

---

- 
99735  
Multi Power 198~264V AC / 180~275V DC

---

- 
99733  
1-10V Multi Power 198~264V AC / 180~275V DC

---

- 
C-E100012  
Push and Simply Dim - DALI-2 Controller

---

- 
C-E100016  
Push and Simply Dim - DALI-2 Controller

## Cables Electrificación

Cable connector	JST Quick connector Male + Female
-----------------	-----------------------------------



Downlights | 1 arrayLED 9 W DC 700 mA | CRI 90  
**77328W10**

Single emission recessed downlights for indoor application. The warm white LED light source with a spot light distribution is composed of 1 arrayed LEDs with CCT of 3000 K and a CRI 90; the source luminous flux is 1119 lm, with a 124.3 lm/W nominal luminous efficacy.

The device body is made of technopolymer and features a white ral 9003 finish; the diffuser is made of uv resistant polycarbonate. The ingress protection degree is IP40; the total weight is of 0.3 kg. The power supply driver is not provided and is to be ordered separately.

The total absorbed power is 9 W. The power supply cable is included and features a 0.2 m length.

The device features protection class III and can be ceiling-mounted, with a 88 mm diameter hole (in plasterboard) with an outer casing, code 89374(for concrete or masonry).

Compliant with the EN 60598-1 standard and its specific provisions.

### Clase de eficiencia energética

Este producto contiene una fuente de luz de clase de eficiencia energética E.

### Características Luminotécnicas

Light Output Ratio (LOR)	70 %
Flujo luminoso (fuente)	1119 lm
Flujo luminoso de luminaria	787 lm
Consumption	9 W
Rendimiento luminoso de las luminarias	87 lm/W
Temperatura de color	3000 K
Standard Deviation of Colour Matching	2 Step MacAdam
Índice de rendimientos cromático	90 Ra

Temperatura estándar del ambiente de servicio	-20 / +50°C
Temperatura típica sobre el vidrio	40°C

### LED Life / Failure Ratio

L70 B10 C0 112960h (at Tj 65 Ta 25 )

### UGR

UGR axial	8
UGR transversal	8
X=4H   Y=8H	S=0.25H
Reflection factor	70/50/20

### OPTICAL

Óptica C0/C180	10°
Light distribution simmetry	Symmetrical

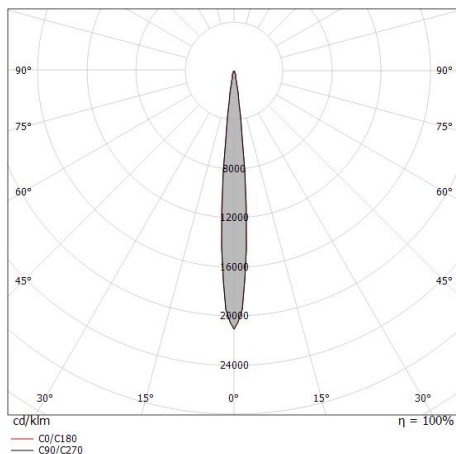

Distance [m]	Cone diameter [m]	illuminance [lx]
0.5	0.09 0.09	E(0°) 66345 E(C90) 5.2° 33179 E(C0) 4.9° 33911
1.0	0.18 0.17	E(0°) 16586 E(C90) 5.2° 8295 E(C0) 4.9° 8478
1.5	0.27 0.26	E(0°) 7372 E(C90) 5.2° 3867 E(C0) 4.9° 3768
2.0	0.36 0.34	E(0°) 4147 E(C90) 5.2° 2074 E(C0) 4.9° 2119
2.5	0.46 0.43	E(0°) 2654 E(C90) 5.2° 1327 E(C0) 4.9° 1356
3.0	0.55 0.51	E(0°) 1843 E(C90) 5.2° 922 E(C0) 4.9° 942

— C0/C180 (Half-peak divergence: 9.8°)  
 — C90/C270 (Half-peak divergence: 10.4°)



Caja de empotrar  
posición de instalación: techo; tipo instalación: albañilería L=200mm, H=113mm,  
D=137mm.  
Material:polipropileno, color:blanco.

**Code**  
89373



Caja de empotrar  
posición de instalación: techo; tipo instalación: albañilería L=370mm, H=120mm,  
D=200mm.  
Material:polipropileno, color:blanco.

**Code**  
89374



Frontal Kit Quantum\_R EVO blanco

**Code**  
83373



Kit frontal Vos\_R EVO negro

**Code**  
83378



Frontal Kit Vos EVO blanco

**Code**  
83377



Kit frontal Quantum\_R EVO negro

**Code**  
83374



Frontal Kit Warp\_R EVO blanco





**Code**  
83375

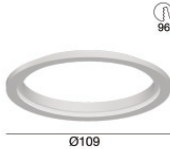
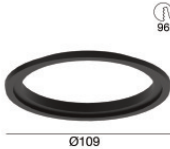
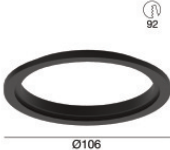
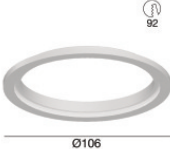

Kit frontal Warp\_R EVO negro

**Code**  
83376



	Brida adaptativa frontal blanca para Warp EVO	<b>Code</b> <u>83395</u>
	Brida adaptativa frontal negra para Warp EVO	<b>Code</b> <u>83390</u>
	Brida adaptativa frontal negra para Quantum EVO 9W-14W	<b>Code</b> <u>83392</u>
	Brida adaptativa frontal blanca para Quantum EVO	<b>Code</b> <u>83391</u>
	Frontal Kit Quantum_R EVO dorado	<b>Code</b> <u>C-K400046</u>
	Frontal Kit Quantum_R EVO cobre	<b>Code</b> <u>C-K400047</u>
	Frontal Kit Warp_R EVO cobre	<b>Code</b> <u>C-K400049</u>
	Frontal Kit Warp_R EVO dorado	<b>Code</b> <u>C-K400048</u>



	<p>Frontal Kit Vos EVO dorado</p>	<p><b>Code</b> <u>C-K400050</u></p>
	<p>Frontal Kit Vos EVO cobre</p>	<p><b>Code</b> <u>C-K400051</u></p>
<p>Ø109</p>	<p>Brida adaptativa frontal oro para Warp EVO</p>	<p><b>Code</b> <u>C-K400052</u></p>
<p>Ø109</p>	<p>Brida adaptativa frontal cobre para Warp EVO</p>	<p><b>Code</b> <u>C-K400053</u></p>
<p>Ø106</p>	<p>Brida adaptativa frontal oro para Quantum EVO</p>	<p><b>Code</b> <u>C-K400054</u></p>
<p>Ø106</p>	<p>Brida adaptativa frontal cobre para Quantum EVO</p>	<p><b>Code</b> <u>C-K400055</u></p>
	<p>antideslumbramiento Tipo antideslumbrante: louvre de nido de abeja. Material:Pom-C, color:Negro.</p>	<p><b>Code</b> <u>83379</u></p>
	<p>Difusor Tipo de difusor: filtro ellittico</p>	<p><b>Code</b> <u>83380</u></p>



Quantum\_R EVO | Downlights | Accessories  
**77328W10**



Difusor  
Tipo de difusor: filtro estético

**Code**  
83381