

Node System_P

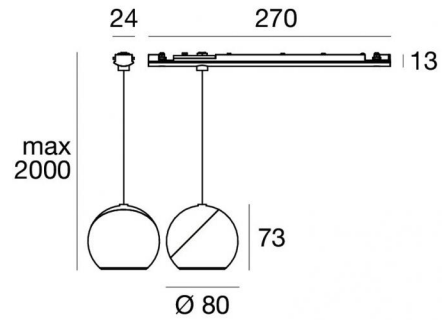

Sistemas | 1 arrayLED 10 W DC 48 V | CRI 92
76431M60





Datos técnicos	
Ambiente de instalación	Interiores
Fuente de luz	LED
Circuit structure	arrayLED
Óptica	Wide Flood
Light emission direction	downward
Potencia nominal	10 W DC
Flujo luminoso (fuente)	959 lm
Rango de voltaje de entrada	210mA
CCT / Tone	2700 K
Índice de rendimientos cromático	92 Ra
C.C. / C.V.	CC
Clase de aislamiento	3
IP	IP40
Test del hilo incandescente	850°
Montaje directo sobre superficies normalmente inflamables	Sí
CE	Sí
Driver incluido.	48V converter
C.V. - C.C. Converter	Convertidor 48V incluido
Artículo regulable	1-10V - DALI-2 - 0-10V - PUSH DIM
Orientabilidad	No
Basculación	No
Practicabilidad	No
Transitabilidad	No
Cable incluido.	No
Resinado	No
Tipología de emisión luminosa	Una emisión
Peso neto	0.723 Kg
Protección descargas electrostáticas	No
Protección contra sobretensiones	No

Acabado cuerpo	
Material	aluminio
Color	Negro
Elaboración	Pintura

Acabado difusor	
Material	PC
Color	transparente

Electrónica

 99784
Switching Driver 180~295V AC / 255~417V DC 150 W

 99785
On/Off Driver 100~305V AC / 142~431V DC 240 W

 83257
On/Off Driver 220~240V AC 96 W

 83259
On/Off Driver 220~240V AC 96 W

 83261
On/Off Driver 100~305V AC / 142~431V DC 150 W

 83263
On/Off Driver 100~305V AC / 142~431V DC 150 W

 83265
On/Off Driver 100~305V AC / 142~431V DC 240 W

 83267
On/Off Driver 100~305V AC / 142~431V DC 240 W



Sistemas | 1 arrayLED 10 W DC 48 V | CRI 92
76431M60

Single emission systems for indoor application. The super warm white LED light source with a wide flood light distribution is composed of 1 arrayed LEDs with CCT of 2700 K and a CRI 92; the source luminous flux is 959 lm, with a 95.9 lm/W nominal luminous efficacy.

The device body is made of aluminium and features a black finish, processed by means of coating; the diffuser is made of PC. The ingress protection degree is IP40; the total weight is of 0.723 kg.

The total absorbed power is 10 W.

The device features protection class III.

Compliant with the EN 60598-1 standard and its specific provisions.

Clase de eficiencia energética

Este producto contiene una fuente de luz de clase de eficiencia energética F.

Características Luminotécnicas

Light Output Ratio (LOR)	97 %
Flujo luminoso (fuente)	959 lm
Flujo luminoso de luminaria	936 lm
Consumption	10 W
Rendimiento luminoso de las luminarias	93 lm/W
Temperatura de color	2700 K
Standard Deviation of Colour Matching	2 Step MacAdam
Índice de rendimientos cromático	92 Ra
Temperatura de unión (luminaria)	80
Black Body Locus	On
Temperatura estándar del ambiente de servicio	-20 / +50°C

LED Life / Failure Ratio

L70 B10 C0 252000h (at Tj 65 Ta 25)

UGR

UGR axial	20.9
UGR transversal	20.8
X=4H Y=8H	S=0.25H
Reflection factor	70/50/20

OPTICAL

Óptica C0/C180	58°
Light distribution simmetry	Symmetrical

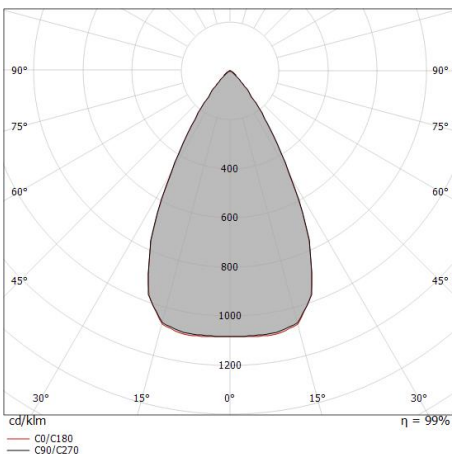

Distance [m]	Cone diameter [m]	illuminance [lx]
0.5	0.55 0.55	E(0°) 4058 E(C90) 28.8° 1379 E(C0) 28.9° 1374
1.0	1.10 1.10	E(0°) 1015 E(C90) 28.8° 345 E(C0) 28.9° 343
1.5	1.65 1.66	E(0°) 451 E(C90) 28.8° 153 E(C0) 28.9° 153
2.0	2.20 2.21	E(0°) 254 E(C90) 28.8° 86 E(C0) 28.9° 86
2.5	2.75 2.76	E(0°) 162 E(C90) 28.8° 55 E(C0) 28.9° 55
3.0	3.30 3.31	E(0°) 113 E(C90) 28.8° 38 E(C0) 28.9° 38

— C0/C180 (Half-peak divergence: 57.8°)
— C90/C270 (Half-peak divergence: 57.6°)



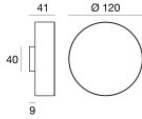

Cubierta de alambre
Material:aluminio, color:Negro, elaboración :Pintura.

Code
83255

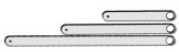

Plantilla

Code
83269

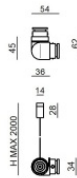

Cables de suspensión
Material:aluminio, color:Negro, elaboración :Pintura.

Code
83272

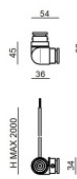

Cables de suspensión
Material:aluminio, color:Negro, elaboración :Pintura.

Code
83274

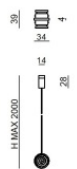

Cables de suspensión
Material:aluminio, color:Negro, elaboración :Pintura.

Code
83276



Cables de suspensión
Material:aluminio, color:Negro, elaboración :Pintura.

Code
83278



Cables de suspensión
Material:aluminio, color:Negro, elaboración :Pintura.

Code
83280

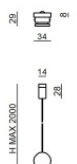

Cables de suspensión
Material:aluminio, color:Negro, elaboración :Pintura.

Code
83282

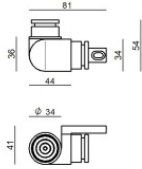

Unión
Material:aluminio, color:Negro, elaboración :Pintura.

Finish	Code
Black	83284

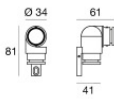

Unión
Material:aluminio, color:Negro, elaboración :Pintura.

Finish	Code
Black	83286



Tapón
Material:aluminio, color:Negro, elaboración :Pintura.

Code
83288

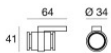

Unión
Tipo linear.
Material:aluminio, color:Negro, elaboración :Pintura.

Finish	Code
Black	83292



Tapón
Material:aluminio, color:Negro, elaboración :Pintura.

Code
83294



Tapón
Material:aluminio, color:Negro, elaboración :Pintura.

Code
83296

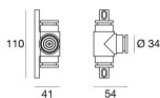

Unión
Material:aluminio, color:Negro, elaboración :Pintura.

Finish	Code
Black	C-U500009

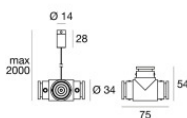

Cables de suspensión
Material:aluminio, color:Negro, elaboración :Pintura.

Code
C-U500011

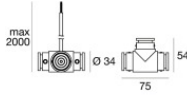

Cables de suspensión
Material:aluminio, color:Negro, elaboración :Pintura.

Code
C-U500013



Carril
Largo: 629mm; Tipo carril: Standard.
Material:aluminio, color:Negro, elaboración :Pintura.

Finish
Black **Code**
83310



Carril
Largo: 1188mm; Tipo carril: Standard.
Material:aluminio, color:Negro, elaboración :Pintura.

Finish
Black **Code**
83312



Carril
Largo: 1748mm; Tipo carril: Standard.
Material:aluminio, color:Negro, elaboración :Pintura.

Finish
Black **Code**
83314



Carril
Largo: 1119mm; Tipo carril: Standard.
Material:PC, color:negro.

Finish
Black **Code**
83317



Carril
Largo: 1679mm; Tipo carril: Standard.
Material:PC, color:negro.

Finish
Black **Code**
83319