

Rubber 3D

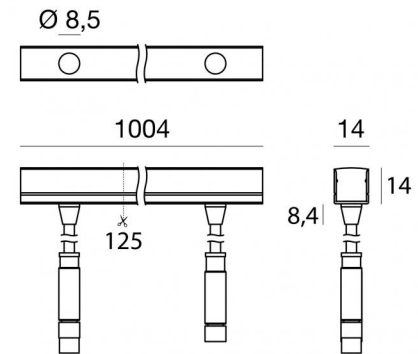

LED Strip | 128 topLED 10 W DC 48 V | 10 W/m
858 Lm/m | CRI >90
C0016ADI01004



Technical data	
Length	1000 mm
Minimum cut	125 mm
Type	10 W DC
Installation position	Wall lights - Ceiling
Installation environment	Outdoor
Light Source	LED
Circuit structure	topLED
Optics	Diffused
Light emission direction	upward
Nominal power	10 W DC
Source lumens	858 lm
Input voltage range	48V
CCT / Tone	2200 K
Colour rendering index	>90 Ra
C.C. / C.V.	CV
Safety class	3
IP	IP67
IK	IK07
Glow wire test	650°
Direct mounting on normally flammable surfaces	Yes
CE	Yes
ETL	Yes
Driver included	No
Dimmable article	DALI - 1-10V
Directional	No
Tilting	No
Walk-over	No
Drive-over	No
Cable included	Yes
Cable length	1(M)x0.25 m + 1(F)x0.25 m
Resin potting	Yes
Type of light emission	Single emission
Length	1000 mm
Net weight	0.103 Kg
Electrostatic discharge protection	No
Surge protection	No

Finishing casing

Material	Technopolymer
Colour	white

Finishing diffuser

Material	PU
Colour	Opal

Electronics

	99784 Switching Driver 180-295V AC / 255-417V DC 150 W (1 - 15 art.)
---	---

	99785 On/Off Driver 100-305V AC / 142-431V DC 240 W (1 - 24 art.)
---	--

	83177 Push and Simply Dim - DMX-RDM Controller (1 - 7 art.)
---	--

	C-E400003 Push and Simply Dim - DALI-2 Controller (1 - 15 art.)
---	--



LED Strip | 128 topLED 10 W DC 48 V | 10 W/m | 858 Lm/m | CRI >90 | Base
C0016ADI01004

Single emission led strip for outdoor application. The ancient white LED light source with a diffused light distribution is composed of 128 topLED LEDs with CCT of 2200 K and a CRI >90; the source luminous flux is 858 lm, with a 85.8 lm/W nominal luminous efficacy.

The device body is made of technopolymer and features a white finish; the diffuser is made of pu. The ingress protection degree is IP67; the total weight is of 0.103 kg. The power supply driver is not provided and is to be ordered separately.

The total absorbed power is 10 W. The power supply cable is included and features a 1(M)x0.25 m + 1(F)x0.25 m length.

The device features protection class III and can be wall lights or ceiling-mounted with an outer casing, code 82199(for concrete or masonry).

Compliant with the EN 60598-1 standard and its specific provisions.

Energy efficiency class

This product contains a light source of energy efficiency class G.

Illuminotechnical Features

Light Output Ratio (LOR)	53 %
Source lumens	858 lm
Delivered lumens	457 lm
Consumption	10 W
Luminaire efficacy	45 lm/W
Colour temperature	2200 K
Standard Deviation of Colour Matching	3 Step MacAdam
Standard Operating Ambient Temperature	-20 / +55°C

LED Life / Failure Ratio

L70 B20 C0 72500h

Rubber 3D



Rubber 3D | LED Strip | Accessories
C0016ADI01004



Outer casing - Linear profile in aluminum 19x18x1000mm for Rubber 3D, Rubber 3D Concrete, Rubber 3D 48V, Rubber 3D Optic, Rubber 3d Pixel
 installation position: wall lights, ceiling L=1000mm, H=18mm, D=19mm.
 Material:Aluminium, colour:Aluminium, processing:Anodisation.

Finish Code
 [Black Box] 99549

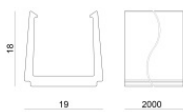
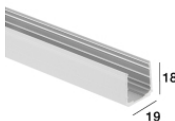

Outer casing - Linear profile in aluminum 19x18x2000mm for Rubber 3D, Rubber 3D Concrete, Rubber 3D 48V, Rubber 3D Optic, Rubber 3D Pixel
 installation position: wall lights, ceiling L=2000mm, H=18mm, D=19mm.
 Material:Aluminium, colour:Aluminium, processing:Anodisation.

Finish Code
 [Black Box] 82198

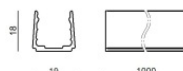

Profile - Black aluminium 18x19 profile 1m for Rubber 3D, Rubber 3D Concrete, Rubber 3D 48V, Rubber 3D Optic, Rubber 3D Pixel
 Material:Aluminium, colour:black, processing:Anodisation.

Code
 C-K100007



Profile - Black aluminium 18x19 profile 1m for Rubber 3D, Rubber 3D Concrete, Rubber 3D 48V, Rubber 3D Optic, Rubber 3D Pixel
 Material:Aluminium, colour:black, processing:Anodisation.

Code
 C-K100008

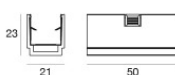

Bracket - Clip with toothed spring - Anodised Aluminium - for Rubber 3D (not for Rubber 3D PROtection)
 installation position: wall lights, ceiling L=50mm, H=23mm, D=21mm.
 Material:Aluminium, colour:Aluminium, processing:Anodisation.

Finish Code
 [Black Box] C-F400001



Bracket - Clip with toothed spring - Anodised Black Aluminium - for Rubber 3D (not for Rubber 3D PROtection)
 installation position: wall lights, ceiling L=50mm, H=23mm, D=21mm.
 Material:Aluminium, colour:black, processing:Anodisation.

Finish Code
 [Black Box] C-F400002

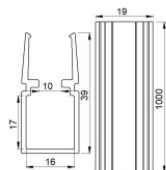

Outer casing - Linear profile with aluminium cable passage 39x18x1000mm for Rubber 3D Concrete, Rubber 3D 48V, Rubber 3D Optic, Rubber 3D Pixel
 installation position: wall lights, ceiling L=2000mm, H=39mm, D=19mm.
 Material:Aluminium, colour:Aluminium, processing:Anodisation.

Finish Code
 [Black Box] 83034

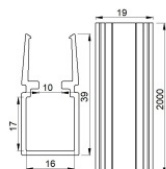

Outer casing - Linear profile with aluminum cable passage 39x18x2000mm for Rubber 3D Concrete, Rubber 3D 48V, Rubber 3D Optic, Rubber 3D Pixel
 installation position: wall lights, ceiling L=1000mm, H=39mm, D=19mm.
 Material:Aluminium, colour:Aluminium, processing:Anodisation.

Finish Code
 [Black Box] 82199

Rubber 3D



Rubber 3D | LED Strip | Accessories
C0016ADI01004

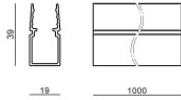

Profile - Profile 39x19 Aluminium black 1m for Rubber 3D, Rubber 3D Concrete, Rubber 3D 48V, Rubber 3D Optic, Rubber 3D Pixel
 Material:Aluminium, colour:black, processing:Anodisation.

Code
C-K100009

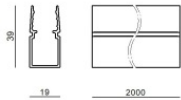

Profile - Profile 39x19 Aluminium black 2m for Rubber 3D, Rubber 3D Concrete, Rubber 3D 48V, Rubber 3D Optic, Rubber 3D Pixel
 Material:Aluminium, colour:black, processing:Anodisation.

Code
C-K100010

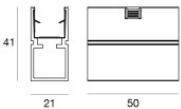

Bracket - Clip with toothed spring with cable passage - Anodised Aluminium - for Rubber 3D (not for Rubber 3D PROtection)
 installation position: wall lights, ceiling L=50mm, H=41mm, D=21mm.
 Material:Aluminium, colour:Aluminium, processing:Anodisation.

Finish
 [Redacted] **Code**
C-F400003

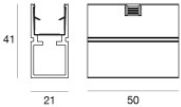

Bracket - Clip with toothed spring with cable passage - Anodised Black Aluminium - for Rubber 3D (not for Rubber 3D PROtection)
 installation position: wall lights, ceiling L=50mm, H=41mm, D=21mm.
 Material:Aluminium, colour:black, processing:Anodisation.

Finish
 [Redacted] **Code**
C-F400004

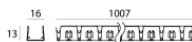

Profile - Flexible profile
 Material:AISI 304 steel, colour:steel.

Code
C-K100011

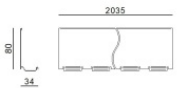
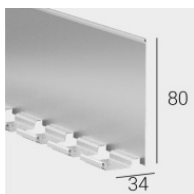

Anti-glare - Anti-glare herringbone eyelid
 Anti-glare Type: eyelid.
 Material:Aluminium 6060, colour:Anodised Aluminum, processing:20 µm anodizing.

Finish
 [Redacted] **Code**
C-K100032

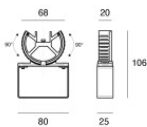

Bag / Fixing kit - TILTING KIT + BRACKET D68X20 - Transparent - for Rubber 3D (not Rubber 3D PROtection)

Code
83352

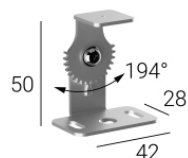

Bag / Fixing kit - Wall-mounted tilting kit in AISI 304 steel

Code
C-K400168

Rubber 3D



Rubber 3D | LED Strip | Accessories

C0016ADI01004

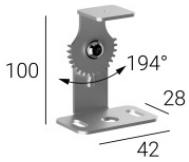

Bag / Fixing kit - Wall-mounted tilting kit in AISI 304 steel

Code
C-K400169



Bag / Fixing kit - RUBBER PEG + BRACKET RUBBER PEG + BRACKET PEG + BRACKET D114X204 for Rubber 3D, Rubber 3D Concrete, Rubber 3D 48V, Rubber 3D Optic, Rubber 3D Pixel

Code
83351



Bag / Fixing kit - Picket with tilting bracket

Code
C-F500004



Bag / Fixing kit - Picket with tilting bracket

Code
C-F500005



Closing cap - PU Rubber
Material:Silicone, colour:transparent.

Code
99539

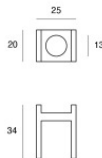

Template

Code
C-V200005

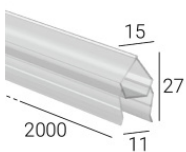

Profile
Material:UV Resistant Polycarbonate, colour:transparent.

Code
C-K100021

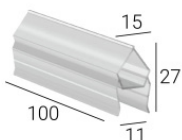

Profile
Material:UV Resistant Polycarbonate, colour:transparent.

Code
C-K100022

Rubber 3D



Rubber 3D | LED Strip | Accessories

C0016ADI01004

	<p>Electronic accessory installation position: ceiling L=218mm, H=42mm, D=31mm. Material:ABS Plastic, colour:white.</p>	<p>Code <u>C-E300007</u></p>
	<p>Electronic accessory installation position: ceiling L=218mm, H=42mm, D=31mm. Material:ABS Plastic, colour:black.</p>	<p>Code <u>C-E300008</u></p>
	<p>Cable gland</p>	<p>Code <u>98990</u></p>
	<p>Connector</p>	<p>Code <u>89548</u></p>
	<p>Strip Service - Double sided tape 33 meters</p>	<p>Code <u>99520</u></p>
	<p>Cable and connector - Cable for Rubber 3D, Rubber 3D Concrete, Rubber 3D 48V, Rubber 3D Optic Length 2000 mm; insulation double; section 0.5 mm²; colors: white - grey.</p>	<p>Code <u>C-W200001</u></p>
	<p>Cable and connector - Cable for Rubber 3D, Rubber 3D Concrete, Rubber 3D 48V, Rubber 3D Optic Length 2000 mm; insulation double; section 0.5 mm²; colors: white - grey.</p>	<p>Code <u>C-W200002</u></p>
	<p>Cable and connector - Cable for Rubber 3D, Rubber 3D Concrete, Rubber 3D 48V, Rubber 3D Optic Length 5000 mm; insulation double; section 0.5 mm²; colors: white - grey.</p>	<p>Code <u>C-W200007</u></p>

Rubber 3D



Rubber 3D | LED Strip | Accessories

C0016ADI01004
