

Rubber 3D Optic V2

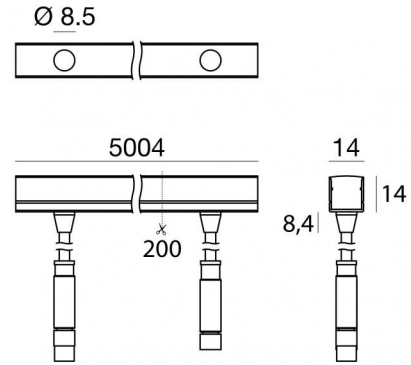

LED Strip | 175 topLED 100 W DC 24 V | 20 W/m
2006 Lm/m | CRI 85
C0010TML05004



| Technical data | |
|--|----------------------------------|
| Length | 5000 mm |
| Minimum cut | 200 mm |
| Type | LED Strip |
| Installation position | Wall lights - Ceiling - Floor |
| Installation environment | Outdoor |
| Light Source | LED |
| Circuit structure | topLED |
| Optics | Medium Flood |
| Light emission direction | frontal |
| Nominal power | 100 W DC |
| Power / m | 20 W / m |
| Source lumens | 10030 lm |
| Source lumens / m | 2006 lm / m |
| Input voltage range | 24V |
| CCT / Tone | 3500 K |
| Colour rendering index | 85 Ra |
| C.C. / C.V. | CV |
| Safety class | 3 |
| IP | IP67 |
| IK | IK07 |
| Glow wire test | 960° |
| Direct mounting on normally flammable surfaces | Yes |
| CE | Yes |
| ETL | Yes |
| Driver included | No |
| Dimmable article | DALI - 1-10V |
| Directional | No |
| Tilting | No |
| Walk-over | No |
| Drive-over | No |
| Cable included | Yes |
| Cable length | 1(M)x0.25 m + 1(F)x0.25 m |
| Resin potting | Yes |
| Type of light emission | Single emission |
| Length | 5000 mm |
| Net weight | 1.45 Kg |
| Electrostatic discharge protection | No |
| Surge protection | No |

Finishing casing

| | |
|----------|---------------|
| Material | Technopolymer |
| Colour | white |

Finishing diffuser

| | |
|----------|------|
| Material | PU |
| Colour | Opal |

Electronics

| | |
|--|---|
| | 99331 On/Off Driver 198~264V AC / 176~275V DC 150 W (1 art.) |
| | 99332 1-10V Controller (1 art.) |
| | 99374 On/Off Driver 198~264V AC / 176~275V DC 75 W (1 art.) |
| | 83333 Push and Simply Dim - DALI-2 Controller (1 art.) |
| | C-E400002 Push and Simply Dim - DALI-2 Controller (1 - 2 art.) |

Rubber 3D Optic V2



LED Strip | 175 topLED 100 W DC 24 V | 20 W/m | 2006 Lm/m | CRI 85
C0010TML05004

Energy efficiency class

This product contains a light source of energy efficiency class F.

Illuminotechnical Features

| | |
|---|----------------|
| Source lumens | 10030 lm |
| Colour temperature | 3500 K |
| Standard Deviation of Colour Matching | 3 Step MacAdam |
| Colour rendering index | 85 Ra |
| Junction temperature (lighting fixture) | 80 |
| Standard Operating Ambient Temperature | -20 / +50°C |

LED Life / Failure Ratio

L70 B20 C0 72500h (at Tj 115 Ta 25)

Single emission led strip for outdoor application. The brilliant white LED light source with a medium flood light distribution is composed of 175 topped LEDs with CCT of 3500 K and a CRI 85; the source luminous flux is 10030 lm, with a 100.3 lm/W nominal luminous efficacy.

The device body is made of technopolymer and features a white finish; the diffuser is made of pu. The ingress protection degree is IP67; the total weight is of 1.45 kg. The power supply driver is not provided and is to be ordered separately.

The total absorbed power is 100 W. The power supply cable is included and features a 1(M)x0.25 m + 1(F)x0.25 m length.

The device features protection class III and can be wall lights, ceiling or floor-mounted with an outer casing, code 82199(for concrete or masonry).

Compliant with the EN 60598-1 standard and its specific provisions.

Rubber 3D Optic V2



Rubber 3D Optic V2 | LED Strip | Accessories
C0010TML05004

| | | <p>Outer casing - Linear profile in aluminum 19x18x1000mm for Rubber 3D, Rubber 3D Concrete, Rubber 3D 48V, Rubber 3D Optic, Rubber 3d Pixel installation position: wall lights, ceiling L=1000mm, H=18mm, D=19mm. Material:Aluminium, colour:Aluminium, processing:Anodisation.</p> | <table border="1"> <thead> <tr> <th>Finish</th> <th>Code</th> </tr> </thead> <tbody> <tr> <td></td> <td>99549</td> </tr> </tbody> </table> | Finish | Code | | 99549 |
|-----------|-----------|---|--|--------|-----------|--|-----------|
| Finish | Code | | | | | | |
| | 99549 | | | | | | |
| | | <p>Outer casing - Linear profile in aluminum 19x18x2000mm for Rubber 3D, Rubber 3D Concrete, Rubber 3D 48V, Rubber 3D Optic, Rubber 3D Pixel installation position: wall lights, ceiling L=2000mm, H=18mm, D=19mm. Material:Aluminium, colour:Aluminium, processing:Anodisation.</p> | <table border="1"> <thead> <tr> <th>Finish</th> <th>Code</th> </tr> </thead> <tbody> <tr> <td></td> <td>82198</td> </tr> </tbody> </table> | Finish | Code | | 82198 |
| Finish | Code | | | | | | |
| | 82198 | | | | | | |
| | | <p>Profile - Black aluminium 18x19 profile 1m for Rubber 3D, Rubber 3D Concrete, Rubber 3D 48V, Rubber 3D Optic, Rubber 3D Pixel Material:Aluminium, colour:black, processing:Anodisation.</p> | <table border="1"> <thead> <tr> <th>Code</th> </tr> </thead> <tbody> <tr> <td>C-K100007</td> </tr> </tbody> </table> | Code | C-K100007 | | |
| Code | | | | | | | |
| C-K100007 | | | | | | | |
| | | <p>Profile - Black aluminium 18x19 profile 1m for Rubber 3D, Rubber 3D Concrete, Rubber 3D 48V, Rubber 3D Optic, Rubber 3D Pixel Material:Aluminium, colour:black, processing:Anodisation.</p> | <table border="1"> <thead> <tr> <th>Code</th> </tr> </thead> <tbody> <tr> <td>C-K100008</td> </tr> </tbody> </table> | Code | C-K100008 | | |
| Code | | | | | | | |
| C-K100008 | | | | | | | |
| | | <p>Bracket - Clip with toothed spring - Anodised Aluminium - for Rubber 3D (not for Rubber 3D PROtection) installation position: wall lights, ceiling L=50mm, H=23mm, D=21mm. Material:Aluminium, colour:Aluminium, processing:Anodisation.</p> | <table border="1"> <thead> <tr> <th>Finish</th> <th>Code</th> </tr> </thead> <tbody> <tr> <td></td> <td>C-F400001</td> </tr> </tbody> </table> | Finish | Code | | C-F400001 |
| Finish | Code | | | | | | |
| | C-F400001 | | | | | | |
| | | <p>Bracket - Clip with toothed spring - Anodised Black Aluminium - for Rubber 3D (not for Rubber 3D PROtection) installation position: wall lights, ceiling L=50mm, H=23mm, D=21mm. Material:Aluminium, colour:black, processing:Anodisation.</p> | <table border="1"> <thead> <tr> <th>Finish</th> <th>Code</th> </tr> </thead> <tbody> <tr> <td></td> <td>C-F400002</td> </tr> </tbody> </table> | Finish | Code | | C-F400002 |
| Finish | Code | | | | | | |
| | C-F400002 | | | | | | |
| | | <p>Outer casing - Linear profile with aluminium cable passage 39x18x1000mm for Rubber 3D, Rubber 3D Concrete, Rubber 3D 48V, Rubber 3D Optic, Rubber 3D Pixel installation position: wall lights, ceiling L=2000mm, H=39mm, D=19mm. Material:Aluminium, colour:Aluminium, processing:Anodisation.</p> | <table border="1"> <thead> <tr> <th>Finish</th> <th>Code</th> </tr> </thead> <tbody> <tr> <td></td> <td>83034</td> </tr> </tbody> </table> | Finish | Code | | 83034 |
| Finish | Code | | | | | | |
| | 83034 | | | | | | |
| | | <p>Outer casing - Linear profile with aluminum cable passage 39x18x2000mm for Rubber 3D, Rubber 3D Concrete, Rubber 3D 48V, Rubber 3D Optic, Rubber 3D Pixel installation position: wall lights, ceiling L=1000mm, H=39mm, D=19mm. Material:Aluminium, colour:Aluminium, processing:Anodisation.</p> | <table border="1"> <thead> <tr> <th>Finish</th> <th>Code</th> </tr> </thead> <tbody> <tr> <td></td> <td>82199</td> </tr> </tbody> </table> | Finish | Code | | 82199 |
| Finish | Code | | | | | | |
| | 82199 | | | | | | |

Rubber 3D Optic V2



Rubber 3D Optic V2 | LED Strip | Accessories
C0010TML05004

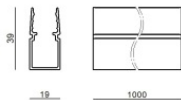

Profile - Profile 39x19 Aluminium black 1m for Rubber 3D, Rubber 3D Concrete, Rubber 3D 48V, Rubber 3D Optic, Rubber 3D Pixel
 Material:Aluminium, colour:black, processing:Anodisation.

Code
C-K100009

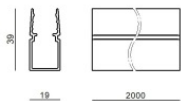

Profile - Profile 39x19 Aluminium black 2m for Rubber 3D, Rubber 3D Concrete, Rubber 3D 48V, Rubber 3D Optic, Rubber 3D Pixel
 Material:Aluminium, colour:black, processing:Anodisation.

Code
C-K100010

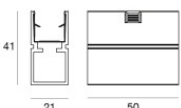

Bracket - Clip with toothed spring with cable passage - Anodised Aluminium - for Rubber 3D (not for Rubber 3D PROtection)
 installation position: wall lights, ceiling L=50mm, H=41mm, D=21mm.
 Material:Aluminium, colour:Aluminium, processing:Anodisation.

Finish
 [Redacted] **Code**
C-F400003

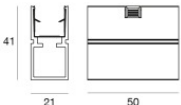

Bracket - Clip with toothed spring with cable passage - Anodised Black Aluminium - for Rubber 3D (not for Rubber 3D PROtection)
 installation position: wall lights, ceiling L=50mm, H=41mm, D=21mm.
 Material:Aluminium, colour:black, processing:Anodisation.

Finish
 [Redacted] **Code**
C-F400004

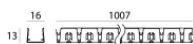

Profile - Flexible profile
 Material:AISI 304 steel, colour:steel.

Code
C-K100011

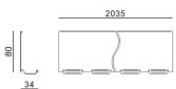
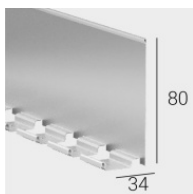

Anti-glare - Anti-glare herringbone eyelid
 Anti-glare Type: eyelid.
 Material:Aluminium 6060, colour:Anodised Aluminum, processing:20 µm anodizing.

Finish
 [Redacted] **Code**
C-K100032

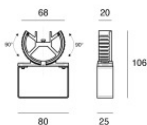

Bag / Fixing kit - TILTING KIT + BRACKET D68X20 - Transparent - for Rubber 3D (not Rubber 3D PROtection)

Code
83352

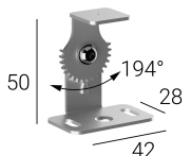

Bag / Fixing kit - Wall-mounted tilting kit in AISI 304 steel

Code
C-K400168

Rubber 3D Optic V2



Rubber 3D Optic V2 | LED Strip | Accessories
C0010TML05004

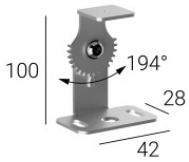

Bag / Fixing kit - Wall-mounted tilting kit in AISI 304 steel

Code
C-K400169



Bag / Fixing kit - RUBBER PEG + BRACKET RUBBER PEG + BRACKET PEG + BRACKET D114X204 for Rubber 3D, Rubber 3D Concrete, Rubber 3D 48V, Rubber 3D Optic, Rubber 3D Pixel

Code
83351

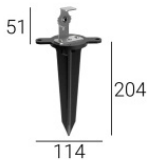

Bag / Fixing kit - Picket with tilting bracket

Code
C-F500004



Bag / Fixing kit - Picket with tilting bracket

Code
C-F500005



Closing cap - PU Rubber
Material:Silicone, colour:transparent.

Code
99539

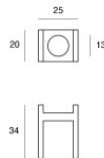

Template

Code
C-V200005

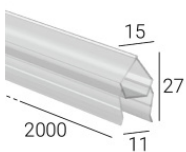

Profile
Material:UV Resistant Polycarbonate, colour:transparent.

Code
C-K100021

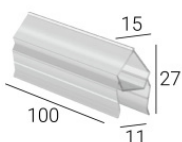

Profile
Material:UV Resistant Polycarbonate, colour:transparent.

Code
C-K100022

Rubber 3D Optic V2



Rubber 3D Optic V2 | LED Strip | Accessories
C0010TML05004

| | | |
|--|--|--|
| | <p>Electronic accessory installation position: ceiling L=218mm, H=42mm, D=31mm. Material:ABS Plastic, colour:white.</p> | <p>Code <u>C-E300007</u></p> |
| | <p>Electronic accessory installation position: ceiling L=218mm, H=42mm, D=31mm. Material:ABS Plastic, colour:black.</p> | <p>Code <u>C-E300008</u></p> |
| | <p>Cable gland</p> | <p>Code <u>98990</u></p> |
| | <p>Connector</p> | <p>Code <u>89548</u></p> |
| | <p>Strip Service - Double sided tape 33 meters</p> | <p>Code <u>99520</u></p> |
| | <p>Cable and connector - Cable for Rubber 3D, Rubber 3D Concrete, Rubber 3D 48V, Rubber 3D Optic Length 2000 mm; insulation double; section 0.5 mm²; colors: white - grey.</p> | <p>Code <u>C-W200001</u></p> |
| | <p>Cable and connector - Cable for Rubber 3D, Rubber 3D Concrete, Rubber 3D 48V, Rubber 3D Optic Length 2000 mm; insulation double; section 0.5 mm²; colors: white - grey.</p> | <p>Code <u>C-W200002</u></p> |
| | <p>Cable and connector - Cable for Rubber 3D, Rubber 3D Concrete, Rubber 3D 48V, Rubber 3D Optic Length 5000 mm; insulation double; section 0.5 mm²; colors: white - grey.</p> | <p>Code <u>C-W200007</u></p> |

Rubber 3D Optic V2



Rubber 3D Optic V2 | LED Strip | Accessories

C0010TML05004
