

# Rubber 3D Optic V2

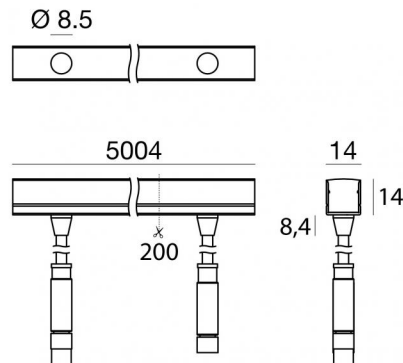

LED Strip | 175 topLED 100 W DC 24 V | 20 W/m  
1547.2 Lm/m | CRI 85

**C0010AFL05004**



Technical data	
Length	5000 mm
Minimum cut	200 mm
Type	LED Strip
Installation position	Wall lights - Ceiling - Floor
Installation environment	Outdoor
Light Source	LED
Circuit structure	topLED
Optics	Flood
Light emission direction	frontal
Nominal power	100 W DC
Power / m	20 W / m
Source lumens	7736 lm
Source lumens / m	1547.2 lm / m
Input voltage range	24V
CCT / Tone	2200 K
Colour rendering index	85 Ra
C.C. / C.V.	CV
Safety class	3
IP	IP67
IK	IK07
Glow wire test	960°
Direct mounting on normally flammable surfaces	Yes
CE	Yes
ETL	Yes
Driver included	No
Dimmable article	DALI - 1-10V
Directional	No
Tilting	No
Walk-over	No
Drive-over	No
Cable included	Yes
Cable length	1(M)x0.25 m + 1(F)x0.25 m
Resin potting	Yes
Type of light emission	Single emission
Length	5000 mm
Net weight	1.45 Kg
Electrostatic discharge protection	No
Surge protection	No

## Finishing casing

Material	Technopolymer
Colour	white

## Finishing diffuser

Material	PU
Colour	Opal

## Electronics

 99331  
On/Off Driver 198~264V AC / 176~275V DC 150 W

 99332  
1-10V Controller

 99374  
On/Off Driver 198~264V AC / 176~275V DC 75 W

 83333  
Push and Simply Dim - DALI-2 Controller

 C-E400002  
Push and Simply Dim - DALI-2 Controller

# Rubber 3D Optic V2



LED Strip | 175 topLED 100 W DC 24 V | 20 W/m | 1547.2 Lm/m | CRI 85  
**C0010AFL05004**

## Energy efficiency class

This product contains a light source of energy efficiency class F.

## Illuminotechnical Features

Source lumens	7736 lm
Colour temperature	2200 K
Standard Deviation of Colour Matching	3 Step MacAdam
Colour rendering index	85 Ra
Junction temperature (lighting fixture)	80
Standard Operating Ambient Temperature	-20 / +50°C

## LED Life / Failure Ratio

L70 B20 C0 72500h (at Tj 115 Ta 25 )

Single emission led strip for outdoor application. The ancient white LED light source with a flood light distribution is composed of 175 topLEDs with CCT of 2200 K and a CRI 85; the source luminous flux is 7736 lm, with a 77.4 lm/W nominal luminous efficacy.

The device body is made of technopolymer and features a white finish; the diffuser is made of pu. The ingress protection degree is IP67; the total weight is of 1.45 kg. The power supply driver is not provided and is to be ordered separately.

The total absorbed power is 100 W. The power supply cable is included and features a 1(M)x0.25 m + 1(F)x0.25 m length.

The device features protection class III and can be wall lights, ceiling or floor-mounted with an outer casing, code 82199(for concrete or masonry).

Compliant with the EN 60598-1 standard and its specific provisions.

# Rubber 3D Optic V2



Rubber 3D Optic V2 | LED Strip | Accessories  
**C0010AFL05004**

		<p>Outer casing - Linear profile in aluminum 19x18x1000mm for Rubber 3D, Rubber 3D Concrete, Rubber 3D 48V, Rubber 3D Optic, Rubber 3d Pixel                      installation position: wall lights, ceiling L=1000mm, H=18mm, D=19mm.                      Material:Aluminium, colour:Aluminium, processing:Anodisation.</p>	<table border="1"> <thead> <tr> <th>Finish</th> <th>Code</th> </tr> </thead> <tbody> <tr> <td></td> <td>99549</td> </tr> </tbody> </table>	Finish	Code		99549
Finish	Code						
	99549						
		<p>Outer casing - Linear profile in aluminum 19x18x2000mm for Rubber 3D, Rubber 3D Concrete, Rubber 3D 48V, Rubber 3D Optic, Rubber 3D Pixel                      installation position: wall lights, ceiling L=2000mm, H=18mm, D=19mm.                      Material:Aluminium, colour:Aluminium, processing:Anodisation.</p>	<table border="1"> <thead> <tr> <th>Finish</th> <th>Code</th> </tr> </thead> <tbody> <tr> <td></td> <td>82198</td> </tr> </tbody> </table>	Finish	Code		82198
Finish	Code						
	82198						
		<p>Profile - Black aluminium 18x19 profile 1m for Rubber 3D, Rubber 3D Concrete, Rubber 3D 48V, Rubber 3D Optic, Rubber 3D Pixel                      Material:Aluminium, colour:black, processing:Anodisation.</p>	<table border="1"> <thead> <tr> <th>Code</th> </tr> </thead> <tbody> <tr> <td>C-K100007</td> </tr> </tbody> </table>	Code	C-K100007		
Code							
C-K100007							
		<p>Profile - Black aluminium 18x19 profile 1m for Rubber 3D, Rubber 3D Concrete, Rubber 3D 48V, Rubber 3D Optic, Rubber 3D Pixel                      Material:Aluminium, colour:black, processing:Anodisation.</p>	<table border="1"> <thead> <tr> <th>Code</th> </tr> </thead> <tbody> <tr> <td>C-K100008</td> </tr> </tbody> </table>	Code	C-K100008		
Code							
C-K100008							
		<p>Bracket - Clip with toothed spring - Anodised Aluminium - for Rubber 3D (not for Rubber 3D PROtection)                      installation position: wall lights, ceiling L=50mm, H=23mm, D=21mm.                      Material:Aluminium, colour:Aluminium, processing:Anodisation.</p>	<table border="1"> <thead> <tr> <th>Finish</th> <th>Code</th> </tr> </thead> <tbody> <tr> <td></td> <td>C-F400001</td> </tr> </tbody> </table>	Finish	Code		C-F400001
Finish	Code						
	C-F400001						
		<p>Bracket - Clip with toothed spring - Anodised Black Aluminium - for Rubber 3D (not for Rubber 3D PROtection)                      installation position: wall lights, ceiling L=50mm, H=23mm, D=21mm.                      Material:Aluminium, colour:black, processing:Anodisation.</p>	<table border="1"> <thead> <tr> <th>Finish</th> <th>Code</th> </tr> </thead> <tbody> <tr> <td></td> <td>C-F400002</td> </tr> </tbody> </table>	Finish	Code		C-F400002
Finish	Code						
	C-F400002						
		<p>Outer casing - Linear profile with aluminium cable passage 39x18x1000mm for Rubber 3D, Rubber 3D Concrete, Rubber 3D 48V, Rubber 3D Optic, Rubber 3D Pixel                      installation position: wall lights, ceiling L=2000mm, H=39mm, D=19mm.                      Material:Aluminium, colour:Aluminium, processing:Anodisation.</p>	<table border="1"> <thead> <tr> <th>Finish</th> <th>Code</th> </tr> </thead> <tbody> <tr> <td></td> <td>83034</td> </tr> </tbody> </table>	Finish	Code		83034
Finish	Code						
	83034						
		<p>Outer casing - Linear profile with aluminum cable passage 39x18x2000mm for Rubber 3D, Rubber 3D Concrete, Rubber 3D 48V, Rubber 3D Optic, Rubber 3D Pixel                      installation position: wall lights, ceiling L=1000mm, H=39mm, D=19mm.                      Material:Aluminium, colour:Aluminium, processing:Anodisation.</p>	<table border="1"> <thead> <tr> <th>Finish</th> <th>Code</th> </tr> </thead> <tbody> <tr> <td></td> <td>82199</td> </tr> </tbody> </table>	Finish	Code		82199
Finish	Code						
	82199						

# Rubber 3D Optic V2



Rubber 3D Optic V2 | LED Strip | Accessories  
**C0010AFL05004**

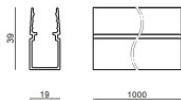

Profile - Profile 39x19 Aluminium black 1m for Rubber 3D, Rubber 3D Concrete, Rubber 3D 48V, Rubber 3D Optic, Rubber 3D Pixel  
 Material:Aluminium, colour:black, processing:Anodisation.

**Code**  
C-K100009

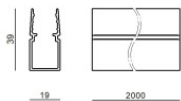

Profile - Profile 39x19 Aluminium black 2m for Rubber 3D, Rubber 3D Concrete, Rubber 3D 48V, Rubber 3D Optic, Rubber 3D Pixel  
 Material:Aluminium, colour:black, processing:Anodisation.

**Code**  
C-K100010

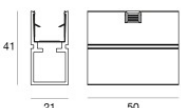

Bracket - Clip with toothed spring with cable passage - Anodised Aluminium - for Rubber 3D (not for Rubber 3D PROtection)  
 installation position: wall lights, ceiling L=50mm, H=41mm, D=21mm.  
 Material:Aluminium, colour:Aluminium, processing:Anodisation.

**Finish**  
 [Redacted]  
**Code**  
C-F400003

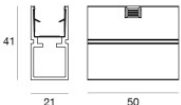

Bracket - Clip with toothed spring with cable passage - Anodised Black Aluminium - for Rubber 3D (not for Rubber 3D PROtection)  
 installation position: wall lights, ceiling L=50mm, H=41mm, D=21mm.  
 Material:Aluminium, colour:black, processing:Anodisation.

**Finish**  
 [Redacted]  
**Code**  
C-F400004

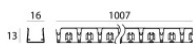

Profile - Flexible profile  
 Material:AISI 304 steel, colour:steel.

**Code**  
C-K100011

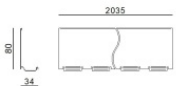
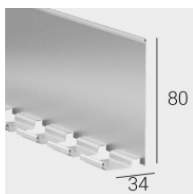

Anti-glare - Anti-glare herringbone eyelid  
 Anti-glare Type: eyelid.  
 Material:Aluminium 6060, colour:Anodised Aluminum, processing:20 µm anodizing.

**Finish**  
 [Redacted]  
**Code**  
C-K100032

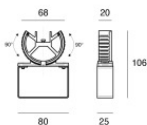

Bag / Fixing kit - TILTING KIT + BRACKET D68X20 - Transparent - for Rubber 3D (not Rubber 3D PROtection)

**Code**  
83352

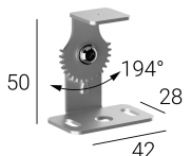

Bag / Fixing kit - Wall-mounted tilting kit in AISI 304 steel

**Code**  
C-K400168

# Rubber 3D Optic V2



Rubber 3D Optic V2 | LED Strip | Accessories  
**C0010AFL05004**

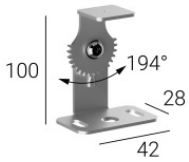

Bag / Fixing kit - Wall-mounted tilting kit in AISI 304 steel

**Code**  
C-K400169



Bag / Fixing kit - RUBBER PEG + BRACKET RUBBER PEG + BRACKET PEG + BRACKET D114X204 for Rubber 3D, Rubber 3D Concrete, Rubber 3D 48V, Rubber 3D Optic, Rubber 3D Pixel

**Code**  
83351

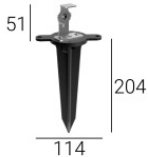

Bag / Fixing kit - Picket with tilting bracket

**Code**  
C-F500004



Bag / Fixing kit - Picket with tilting bracket

**Code**  
C-F500005



Closing cap - PU Rubber  
Material:Silicone, colour:transparent.

**Code**  
99539

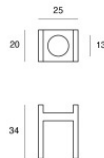

Template

**Code**  
C-V200005

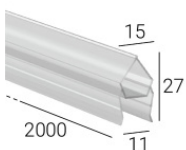

Profile  
Material:UV Resistant Polycarbonate, colour:transparent.

**Code**  
C-K100021

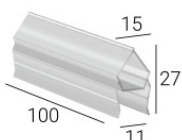

Profile  
Material:UV Resistant Polycarbonate, colour:transparent.

**Code**  
C-K100022

# Rubber 3D Optic V2



Rubber 3D Optic V2 | LED Strip | Accessories  
**C0010AFL05004**

	<p>Electronic accessory                      installation position: ceiling L=218mm, H=42mm, D=31mm.                      Material:ABS Plastic, colour:white.</p>	<p><b>Code</b>  <u>C-E300007</u></p>
	<p>Electronic accessory                      installation position: ceiling L=218mm, H=42mm, D=31mm.                      Material:ABS Plastic, colour:black.</p>	<p><b>Code</b>  <u>C-E300008</u></p>
	<p>Cable gland</p>	<p><b>Code</b>  <u>98990</u></p>
	<p>Connector</p>	<p><b>Code</b>  <u>89548</u></p>
	<p>Strip Service - Double sided tape 33 meters</p>	<p><b>Code</b>  <u>99520</u></p>
	<p>Cable and connector - Cable for Rubber 3D, Rubber 3D Concrete, Rubber 3D 48V, Rubber 3D Optic                      Length 2000 mm; insulation double; section 0.5 mm<sup>2</sup>; colors: white - grey.</p>	<p><b>Code</b>  <u>C-W200001</u></p>
	<p>Cable and connector - Cable for Rubber 3D, Rubber 3D Concrete, Rubber 3D 48V, Rubber 3D Optic                      Length 2000 mm; insulation double; section 0.5 mm<sup>2</sup>; colors: white - grey.</p>	<p><b>Code</b>  <u>C-W200002</u></p>
	<p>Cable and connector - Cable for Rubber 3D, Rubber 3D Concrete, Rubber 3D 48V, Rubber 3D Optic                      Length 5000 mm; insulation double; section 0.5 mm<sup>2</sup>; colors: white - grey.</p>	<p><b>Code</b>  <u>C-W200007</u></p>

# Rubber 3D Optic V2

---



Rubber 3D Optic V2 | LED Strip | Accessories

**C0010AFL05004**

---