

Nautilus_R

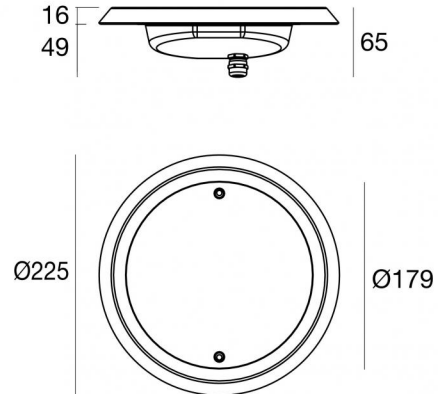

Submerged | 9 x powerLEDs 38 W DC 12 V | CRI 80
C00084SENX2



Technical data	
Type	Frame
Installation position	Wall lights - Floor
Installation environment	Outdoor
Light Source	LED
Circuit structure	powerLEDs
Optics	Mix Flux 2 Asymmetric + Flood
Light emission direction	frontal
Nominal power	38 W DC
Source lumens	4921 lm
Input voltage range	12V
CCT / Tone	4000 K
Colour rendering index	80 Ra
C.C. / C.V.	CV
Safety class	3
IP	IP68
Maximum installation depth	25 m
Installation limitations	Only underwater
IK	IK10
Glow wire test	850°
Direct mounting on normally flammable surfaces	Yes
CE	Yes
Driver included	No
Dimmable article	DALI - 1-10V
Directional	No
Tilting	No
Walk-over	No
Drive-over	No
Cable included	Yes
Cable length	20 m
Resin potting	Yes
Type of light emission	Single emission
Net weight	2.3 Kg
Electrostatic discharge protection	No
Surge protection	No
Product technological characteristics	Acquastop

Finishing casing

Material	AISI 316L steel
Colour	steel





Finishing diffuser

Material	Extra clear glass - Tempered
Colour	transparent
Processing	Silk-screening

Finishing flange

Material	Stainless steel 316
Colour	steel
Processing	electropolishing

Electronics

	83010 On/Off Driver 90~264V AC / 127~370V DC 60 W (1 art.)
	83015 DALI Controller 90~305V AC / 127~431V DC 120 W (1 - 3 art.)
	83013 On/Off Driver 180~305V AC / 254~431V DC 120 W (1 - 3 art.)
	83012 DALI Controller 90~305V AC / 127~431V DC 60 W (1 art.)



Submerged | 9 x powerLEDs 38 W DC 12 V | CRI 80 | Base
C00084SENX2

Single emission submerged for outdoor application. The natural white LED light source with a mix flux 2 asymmetric + flood light distribution is composed of 9 powered LEDs with CCT of 4000 K and a CRI 80; the source luminous flux is 4921 lm, with a 129.5 lm/W nominal luminous efficacy.

The device body is made of aisi 316l steel and features a steel finish; the diffuser is made of extra clear glass - tempered with a silk-screening treatment. The ingress protection degree is IP68; the total weight is of 2.3 kg. The power supply driver is not provided and is to be ordered separately.

The total absorbed power is 38 W. The power supply cable is included and features a 20 m length.

The device features protection class III and can be wall lights or floor-mounted with an outer casing, code 83198(for concrete or masonry).

Compliant with the EN 60598-1 standard and its specific provisions.

Energy efficiency class

This product contains 3 light sources of energy efficiency class E.

Illuminotechnical Features

Light Output Ratio (LOR)	74 %
Source lumens	4921 lm
Delivered lumens	3651 lm
Consumption	38 W
Luminaire efficacy	96 lm/W
Colour temperature	4000 K
Standard Deviation of Colour Matching	3 Step MacAdam
Colour rendering index	80 Ra
Standard Operating Ambient Temperature	-20 / +50°C
Ordinary temperature on the glass	40°C

LED Life / Failure Ratio

L70 B10 C0 250000h (at Tj 65 Ta 25)

OPTICAL

C0/C180 optics	33°
Light distribution symmetry	Asymmetrical

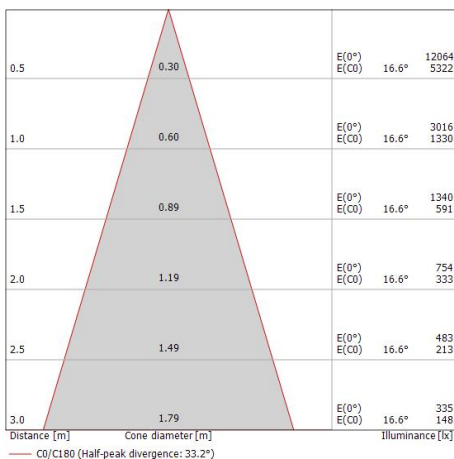
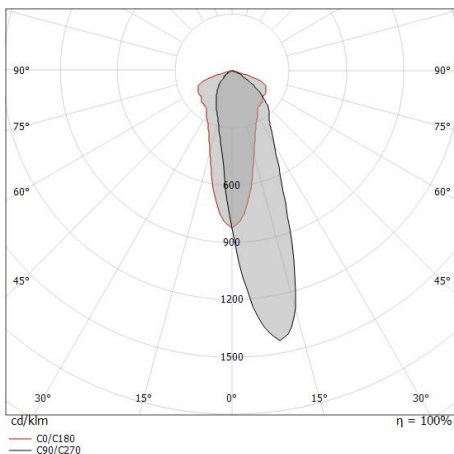



Nautilus_R | Submerged | Accessories
C00084SENX2

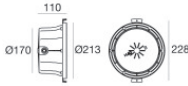

Outer casing - IP68 casing for installation on masonry (tiles or mosaic)
installation position: wall lights; type of installation: masonry L=213mm, H=213mm,
D=110mm.
Material:ABS Plastic, colour:black.

Code
83142

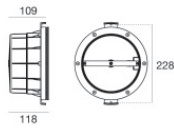

Outer casing - Outer Casing for installation on canvas
installation position: wall lights; type of installation: masonry L=213mm, H=213mm,
D=110mm.
Material:ABS Plastic, colour:black.

Code
83198