

Nautilus_R

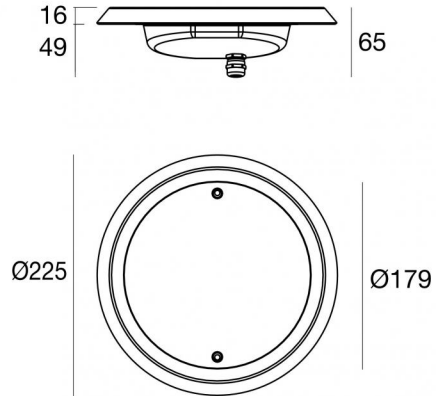

Submerged | 6 x powerLEDs 18 W DC 500 mA
 RGBW - 3000
84043V25



Technical data	
Type	Frame
Installation position	Wall lights - Floor
Installation environment	Outdoor
Light Source	LED
Circuit structure	powerLEDs
Optics	Elliptic Medium Flood
Light emission direction	frontal
Nominal power	18 W DC
Input voltage range	500mA
CCT / Tone	RGBW - 3000 K
C.C. / C.V.	CC
Safety class	3
IP	IP68
Maximum installation depth	25 m
Installation limitations	Only underwater
IK	IK10
Glow wire test	850°
Direct mounting on normally flammable surfaces	Yes
CE	Yes
Driver included	No
Dimmable article	Yes
Directional	No
Tilting	No
Walk-over	No
Drive-over	No
Cable included	Yes
Cable length	5 m
Resin potting	Yes
Type of light emission	Single emission
Net weight	2.44 Kg
Electrostatic discharge protection	No
Surge protection	No
Product technological characteristics	Acquastop

Finishing casing

Material	AISI 316L steel
Colour	steel

Finishing diffuser

Material	Extra clear glass - Tempered
Colour	transparent
Processing	Silk-screening

Finishing flange

Material	Stainless steel 316
Colour	steel
Processing	electropolishing

Electronics

 83010
 On/Off Driver 90~264V AC / 127~370V DC 60 W (1 - 3 art.)

 83187
 Push and Simply Dim - DMX-RDM Multi Channel 4ch. 10.8~52.8V DC (1 art.)

Lumen RGBW

N. Led	Red	Green	Blue	white
6	192 lm	492 lm	162 lm	552 lm



Submerged | 6 x powerLEDs 18 W DC 500 mA | RGBW - 3000
84043V25

Single emission submerged for outdoor application. The RGBW - 3000 K LED light source with a elliptic medium flood light distribution is composed of 6 powerled LEDs with CCT of RGB-W 3000 K.

The device body is made of aisi 316l steel and features a steel finish; the diffuser is made of extra clear glass - tempered with a silk-screening treatment. The ingress protection degree is IP68; the total weight is of 2.44 kg. The power supply driver is not provided and is to be ordered separately.

The total absorbed power is 18 W. The power supply cable is included and features a 5 m length.

The device features protection class III and can be wall lights or floor-mounted with an outer casing, code 83198(for concrete or masonry).

Compliant with the EN 60598-1 standard and its specific provisions.

Standard Operating Ambient Temperature	-20 / +50°C
Ordinary temperature on the glass	40°C



Nautilus_R | Submerged | Accessories
84043V25

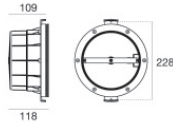

Outer casing - Outer Casing for installation on canvas
installation position: wall lights; type of installation: masonry L=213mm, H=213mm,
D=110mm.
Material:ABS Plastic, colour:black.

Code
83198

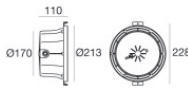

Outer casing - IP68 casing for installation on masonry (tiles or mosaic)
installation position: wall lights; type of installation: masonry L=213mm, H=213mm,
D=110mm.
Material:ABS Plastic, colour:black.

Code
83142

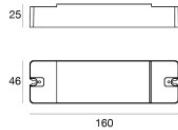

Dimmer
RF Remote controller

Code
C-E700003

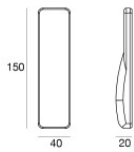

RF remote control

Code
C-W600001