

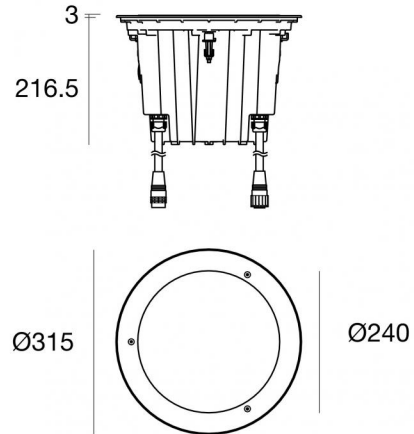

Uplights | 198-264 V AC /180-275 V DC
1 arrayLED 37 W DC - 41 W AC | RGBW - 3000
83941V15



Technical data	
Type	Drive Over
Installation position	Floor
Installation environment	Outdoor
Light Source	LED
Circuit structure	arrayLED
Optics	Spot
Light emission direction	upward
Nominal power	37 W DC
Total Power	41 W
Input voltage range	198 - 264 V AC
Frequency	50 - 60 Hz
CCT / Tone	RGBW - 3000 K
C.C. / C.V.	AC
Safety class	1
IP	IP68
Installation limitations	Not for underwater use
IK	IK10
Glow wire test	850°
Direct mounting on normally flammable surfaces	No
CE	Yes
Driver included	Control unit/Driver
Dimmable article	DMX-RDM
Directional	No
Tilting	No
Walk-over	Yes
Drive-over	5000 Kg
Cable included	Yes
Cable length	0.2 m
Resin potting	Yes
Type of light emission	Single emission
Net weight	8 Kg
Electrostatic discharge protection	Yes
Surge protection	Yes
Product technological characteristics	Acquastop

Finishing casing

Material	Die-cast Aluminium EN AB - 46100
Colour	black
Processing	Open pore anodizing + Powder Coating

Finishing diffuser

Material	Extra clear glass - Tempered
Colour	transparent
Processing	Silk-screening

Finishing flange

Material	AISI 316 steel
Colour	steel
Processing	Brushing

Cables Electrification+signal

Cable connector AllinONE Male Plug 6 Pin

IP (locked condition) 67

Cable connector ALLinONE Female Socket 6 Pin

Lumen RGBW

N. Led	Red	Green	Blue	white
1	438 lm	894 lm	318 lm	1206 lm



Uplights | 198-264 V AC /180-275 V DC | 1 arrayLED 37 W DC - 41 W AC | RGBW - 3000
83941V15

Single emission uplights for outdoor application. The RGBW - 3000 K LED light source with a spot light distribution is composed of 1 arrayled LEDs with CCT of RGB-W 3000 K.

The device body is made of die-cast aluminium en ab - 46100 and features a black finish, processed by means of open pore anodizing + powder coating; the diffuser is made of extra clear glass - tempered with a silk-screening treatment. The ingress protection degree is IP68; the total weight is of 8 kg.









The total absorbed power is 37 W. The power supply cable is included and features a 0.2 m length.

The device features protection class I and can be floor-mounted with an outer casing, code 83096(for concrete or masonry).

Compliant with the EN 60598-1 standard and its specific provisions.

Standard Operating Ambient Temperature	-20 / +50°C
Ordinary temperature on the glass	65°C

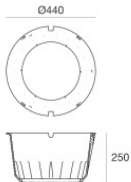

<p>L. 1m</p> 	<p>Cable and connector Type of cable power + signal cable allinone; Length 1000 mm; insulation double with shielding for signal; external diameter: 12.6 mm; colors: white - blue - red - grey - brown - yellow-green.</p>	<p>Code <u>98660</u></p>
<p>L. 5m</p> 	<p>Cable and connector Type of cable power + signal cable allinone; Length 5000 mm; insulation double with shielding for signal; external diameter: 12.6 mm; colors: white - blue - red - grey - brown - yellow-green.</p>	<p>Code <u>98661</u></p>
<p>L. 1m</p> 	<p>Cable and connector Type of cable power + signal cable allinone; Length 1000 mm; insulation double with shielding for signal; external diameter: 12.6 mm.</p>	<p>Code <u>98662</u></p>
<p>L. 5m</p> 	<p>Cable and connector Type of cable power + signal cable allinone; Length 5000 mm; insulation double with shielding for signal; external diameter: 12.6 mm.</p>	<p>Code <u>98663</u></p>
 	<p>Connector - Start splitter Type of cable power + signal cable allinone; Length 5000 + 5000 + 200 mm; insulation double with shielding for signal.</p>	<p>Code <u>98985</u></p>
 	<p>Connector - Continuity splitter Type of cable power + signal cable allinone; Length 200 + 200 + 5000 mm; insulation double with shielding for signal.</p>	<p>Code <u>99390</u></p>
	<p>Connector - DMX line closure adapter for ALLinONE cables Type of cable power + signal cable allinone; ; insulation double with shielding for signal.</p>	<p>Code <u>98986</u></p>
 	<p>Outer casing installation position: floor, land; type of installation: masonry L=440mm, H=250mm, D=440mm. Material:ABS Plastic, colour:black.</p>	<p>Code <u>83096</u></p>



Suelo_RX | Uplights | Accessories
83941V15



Template

Code
83097



Accessories for outer casings - Caseback for outercasing
Material:Galvanised Iron, colour:grey, processing:Galvanising.

Code
93099