

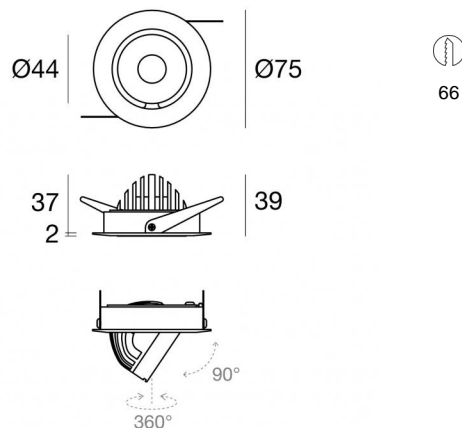

Downlights | 1 x powerLED 4 W DC 350 mA | CRI 90  
**82739W85**



66

## Technical data

Type	Encasement with flange
Installation position	Ceiling
Installation environment	Indoor
Light Source	LED
Circuit structure	powerLED
Optics	Adjustable Focus
Light emission direction	downward
Nominal power	4 W DC
Source lumens	416 lm
Input voltage range	350mA
CCT / Tone	3000 K
Colour rendering index	90 Ra
C.C. / C.V.	CC
Safety class	3
IP	IP20
Glow wire test	850°
Direct mounting on normally flammable surfaces	Yes
CE	Yes
Driver included	No
Dimmable article	DALI - 1-10V
Directional	Extractable
total angle (vertical plane)	90 °
total angle (horizontal plane)	360 °
Tilting	No
Walk-over	No
Drive-over	No
Cable included	Yes
Cable length	0.2 m
Resin potting	No
Type of light emission	Single emission
Net weight	0.1 Kg
Electrostatic discharge protection	No
Surge protection	No

## Finishing casing

Material	Die-cast Aluminium EN AB - 46100
Colour	White
Processing	Powder coating

## Electronics

 89145  
 On/Off Driver 198~264V AC / 180~275V DC (1 art.)

 99375  
 On/Off Driver 198~264V AC (2 - 3 art.)

 C-E100010  
 1-10V - 0-10V Controller (1 art.)

 C-E100011  
 Push and Simply Dim - DALI-2 Controller (1 art.)

## Cables Electrification

Cable connector	No
-----------------	----

Downlights | 1 x powerLED 4 W DC 350 mA | CRI 90 | Angle Max  
82739W85

Single emission recessed downlights for indoor application. The warm white LED light source with a adjustable focus light distribution is composed of 1 powerled LEDs with CCT of 3000 K and a CRI 90; the source luminous flux is 416 lm, with a 104.0 lm/W nominal luminous efficacy.

The device body is made of die-cast aluminium en ab - 46100 and features a white finish, processed by means of powder coating. The ingress protection degree is IP20; the total weight is of 0.1 kg. The power supply driver is not provided and is to be ordered separately.

The total absorbed power is 4 W. The power supply cable is included and features a 0.2 m length.

The device features protection class III and can be ceiling-mounted, with a 66 mm diameter hole (in plasterboard).

Compliant with the EN 60598-1 standard and its specific provisions.

### Energy efficiency class

This product contains a light source of energy efficiency class F.

### Illuminotechnical Features

Light Output Ratio (LOR)	23 %
Source lumens	416 lm
Delivered lumens	96 lm
Consumption	4 W
Luminaire efficacy	24 lm/W
Colour temperature	3000 K
Standard Deviation of Colour Matching	3 Step MacAdam
Colour rendering index	90 Ra
Black Body Locus	On

Standard Operating Ambient Temperature	-20 / +50°C
Ordinary temperature on the glass	40°C

### LED Life / Failure Ratio

L70 B10 C0 247450h (at Tj 60 Ta 25 )

### UGR

UGR axial	17.7
UGR transversal	17.6
X=4H   Y=8H	S=0.25H
Reflection factor	70/50/20

### OPTICAL

C0/C180 optics	18°
Light distribution simmetry	Symmetrical

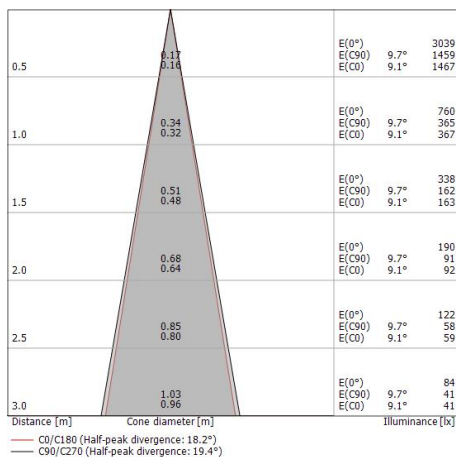
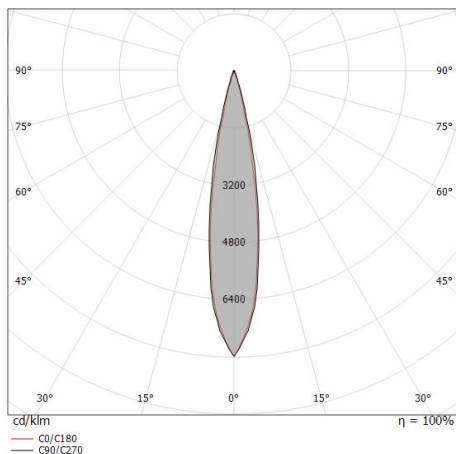

Downlights | 1 x powerLED 4 W DC 350 mA | CRI 90 | Angle Min  
**82739W85**

Single emission recessed downlights for indoor application. The warm white LED light source with a adjustable focus light distribution is composed of 1 powerled LEDs with CCT of 3000 K and a CRI 90; the source luminous flux is 416 lm, with a 104.0 lm/W nominal luminous efficacy.

The device body is made of die-cast aluminium en ab - 46100 and features a white finish, processed by means of powder coating. The ingress protection degree is IP20; the total weight is of 0.1 kg. The power supply driver is not provided and is to be ordered separately.

The total absorbed power is 4 W. The power supply cable is included and features a 0.2 m length.

The device features protection class III and can be ceiling-mounted, with a 66 mm diameter hole (in plasterboard).

Compliant with the EN 60598-1 standard and its specific provisions.

### Energy efficiency class

This product contains a light source of energy efficiency class F.

### Illuminotechnical Features

Light Output Ratio (LOR)	18 %
Source lumens	416 lm
Delivered lumens	76 lm
Consumption	4 W
Luminaire efficacy	19 lm/W
Colour temperature	3000 K
Standard Deviation of Colour Matching	3 Step MacAdam
Colour rendering index	90 Ra
Black Body Locus	On
Standard Operating Ambient Temperature	-20 / +50°C
Ordinary temperature on the glass	40°C

### LED Life / Failure Ratio

L70 B10 C0 247450h (at Tj 60 Ta 25 )

### UGR

UGR axial	18.2
UGR transversal	17.5
X=4H   Y=8H	S=0.25H
Reflection factor	70/50/20

### OPTICAL

C0/C180 optics	14°
Light distribution simmetry	Symmetrical

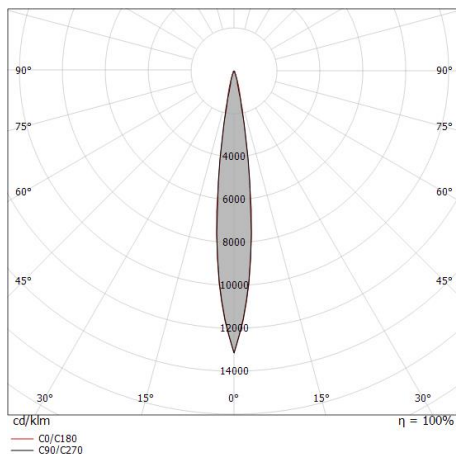

Distance [m]	Cone diameter [m]	Illuminance [lx]
0.5	0.12 0.12	E(0°) 3948 E(C90) 6.8° 1955 E(C0) 6.9° 1957
1.0	0.24 0.24	E(0°) 987 E(C90) 6.8° 489 E(C0) 6.9° 489
1.5	0.36 0.36	E(0°) 439 E(C90) 6.8° 217 E(C0) 6.9° 217
2.0	0.48 0.48	E(0°) 247 E(C90) 6.8° 122 E(C0) 6.9° 122
2.5	0.60 0.61	E(0°) 158 E(C90) 6.8° 78 E(C0) 6.9° 78
3.0	0.72 0.73	E(0°) 110 E(C90) 6.8° 54 E(C0) 6.9° 54

— C0/C180 (Half-peak divergence: 13.8°)  
 — C90/C270 (Half-peak divergence: 13.6°)

### COLOR VECTOR GRAPHIC

