

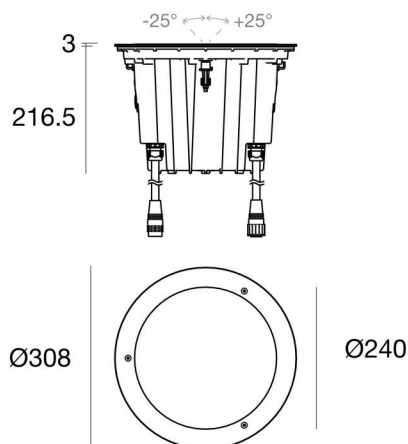

Uplights | 198-264 V AC /180-275 V DC  
24 x powerLEDs 37 W DC - 41 W AC | RGBW - 3000  
**82724V30**



Technical data	
Type	Drive Over
Installation position	Floor
Installation environment	Outdoor
Light Source	LED
Circuit structure	powerLEDs
Optics	Medium Flood
Light emission direction	upward
Nominal power	37 W DC
Total Power	41 W
Input voltage range	198 - 264 V AC
Frequency	50 - 60 Hz
CCT / Tone	RGBW - 3000 K
C.C. / C.V.	AC
Safety class	1
IP	IP68
Installation limitations	Not for underwater use
IK	IK10
Glow wire test	850°
Direct mounting on normally flammable surfaces	No
CE	Yes
Driver included	Control unit/Driver
Dimmable article	DMX-RDM
Directional	No
Tilting	Yes
total angle (vertical plane)	50 °
Walk-over	Yes
Drive-over	5000 Kg
Cable included	Yes
Cable length	0.2 m
Resin potting	Yes
Type of light emission	Single emission
Net weight	8 Kg
Electrostatic discharge protection	Yes
Surge protection	Yes
Product technological characteristics	Acquastop

Finishing casing	
Material	Die-cast Aluminium EN AB - 46100
Colour	black
Processing	Open pore anodizing + Powder Coating

Finishing diffuser	
Material	Extra clear glass - Tempered
Colour	transparent
Processing	Silk-screening

Finishing flange	
Material	AISI 316 steel
Colour	steel
Processing	Brushing

Cables Electrification+signal	
IP (locked condition)	67
Cable connector	ALLinONE Female Socket 6 Pin
Cable connector	AllinONE Male Plug 6 Pin

Lumen RGBW				
N. Led	Red	Green	Blue	white
24	438 lm	894 lm	318 lm	1206 lm



Uplights | 198-264 V AC /180-275 V DC | 24 x powerLEDs 37 W DC - 41 W AC | RGBW - 3000  
**82724V30**

Single emission uplights for outdoor application. The RGBW - 3000 K LED light source with a medium flood light distribution is composed of 24 powered LEDs with CCT of RGB-W 3000 K.

The device body is made of die-cast aluminium en ab - 46100 and features a black finish, processed by means of open pore anodizing + powder coating; the diffuser is made of extra clear glass - tempered with a silk-screening treatment. The ingress protection degree is IP68; the total weight is of 8 kg.

The total absorbed power is 37 W. The power supply cable is included and features a 0.2 m length.

The device features protection class I and can be floor-mounted with an outer casing, code 83096(for concrete or masonry).

Compliant with the EN 60598-1 standard and its specific provisions.

#### Energy efficiency class

This product contains a light source of energy efficiency class E.

#### Illuminotechnical Features











Standard Deviation of Colour Matching	3 Step MacAdam
Colour rendering index	90 Ra
Standard Operating Ambient Temperature	-20 / +50°C
Ordinary temperature on the glass	65°C

#### LED Life / Failure Ratio

L70 B10 C0 60500h

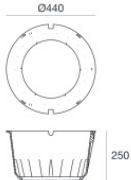

Suelo\_RXFJ | Uplights | Accessories  
82724V30

<p><b>L. 1m</b></p> 	<p>Cable and connector Type of cable power + signal cable allinone; Length 1000 mm; insulation double with shielding for signal; external diameter: 12.6 mm; colors: white - blue - red - grey - brown - yellow-green.</p>	<p><b>Code</b> <u>98660</u></p>
<p><b>L. 5m</b></p> 	<p>Cable and connector Type of cable power + signal cable allinone; Length 5000 mm; insulation double with shielding for signal; external diameter: 12.6 mm; colors: white - blue - red - grey - brown - yellow-green.</p>	<p><b>Code</b> <u>98661</u></p>
<p><b>L. 1m</b></p> 	<p>Cable and connector Type of cable power + signal cable allinone; Length 1000 mm; insulation double with shielding for signal; external diameter: 12.6 mm.</p>	<p><b>Code</b> <u>98662</u></p>
<p><b>L. 5m</b></p> 	<p>Cable and connector Type of cable power + signal cable allinone; Length 5000 mm; insulation double with shielding for signal; external diameter: 12.6 mm.</p>	<p><b>Code</b> <u>98663</u></p>
 	<p>Connector - Start splitter Type of cable power + signal cable allinone; Length 5000 + 5000 + 200 mm; insulation double with shielding for signal.</p>	<p><b>Code</b> <u>98985</u></p>
 	<p>Connector - Continuity splitter Type of cable power + signal cable allinone; Length 200 + 200 + 5000 mm; insulation double with shielding for signal.</p>	<p><b>Code</b> <u>99390</u></p>
	<p>Connector - DMX line closure adapter for ALLinONE cables Type of cable power + signal cable allinone; ; insulation double with shielding for signal.</p>	<p><b>Code</b> <u>98986</u></p>
 	<p>Outer casing installation position: floor, land; type of installation: masonry L=440mm, H=250mm, D=440mm. Material:ABS Plastic, colour:black.</p>	<p><b>Code</b> <u>83096</u></p>



Suelo\_RXFJ | Uplights | Accessories  
**82724V30**

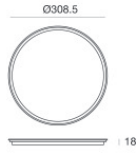

Template

**Code**  
83098

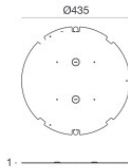

Accessories for outer casings - Caseback for outer casing  
Material:Galvanised Iron, colour:grey, processing:Galvanising.

**Code**  
93099