

Cob40_R

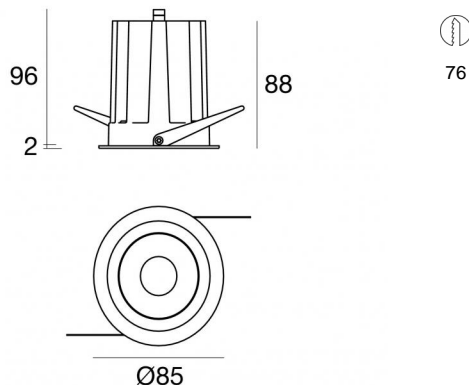

Downlights | 1 arrayLED 18 W DC 500 mA | CRI 90
82473M15



Technical data

Type	Encasement with flange
Installation position	Ceiling
Installation environment	Indoor
Light Source	LED
Circuit structure	arrayLED
Optics	Spot
Light emission direction	downward
Nominal power	18 W DC
Source lumens	2692 lm
Input voltage range	500mA
CCT / Tone	2700 K
Colour rendering index	90 Ra
C.C. / C.V.	CC
Safety class	3
IP	IP40
Optical compartment IP	IP44
IK	IK05
Glow wire test	850°
Direct mounting on normally flammable surfaces	Yes
CE	Yes
Driver included	No
Dimmable article	DALI - 1-10V
Directional	No
Tilting	No
Walk-over	No
Drive-over	No
Cable included	Yes
Cable length	0.15 m
Resin potting	No
Type of light emission	Single emission
Net weight	0.375 Kg
Electrostatic discharge protection	No
Surge protection	No

Finishing casing

Material	Die-cast Aluminium EN AB - 46100
Colour	White
Processing	Powder coating

Electronics

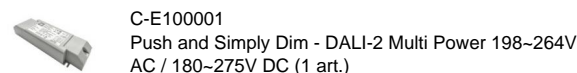
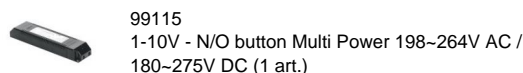

Cables Electrification

Cable connector	MALE JST SMR-02V-B
Cable connector	FEMALE JST SMP-02V-BC



Downlights | 1 arrayLED 18 W DC 500 mA | CRI 90 | Base
82473M15

Single emission recessed downlights for indoor application. The super warm white LED light source with a spot light distribution is composed of 1 arrayLEDs with CCT of 2700 K and a CRI 90; the source luminous flux is 2692 lm, with a 149.6 lm/W nominal luminous efficacy.

The device body is made of die-cast aluminium en ab - 46100 and features a white finish, processed by means of powder coating. The ingress protection degree is IP40; the total weight is of 0.375 kg. The power supply driver is not provided and is to be ordered separately.

The total absorbed power is 18 W. The power supply cable is included and features a 0.15 m length.

The device features protection class III and can be ceiling-mounted, with a 76 mm diameter hole (in plasterboard) with an outer casing, code 89374(for concrete or masonry).

Compliant with the EN 60598-1 standard and its specific provisions.

Energy efficiency class

This product contains a light source of energy efficiency class E.

Illuminotechnical Features

Light Output Ratio (LOR)	79 %
Source lumens	2692 lm
Delivered lumens	2147 lm
Consumption	18 W
Luminaire efficacy	119 lm/W
Colour temperature	2700 K
Standard Deviation of Colour Matching	2 Step MacAdam
Colour rendering index	90 Ra
Colour Rendering Index	60 R9
Black Body Locus	On
Standard Operating Ambient Temperature	-20 / +50°C
Ordinary temperature on the glass	40°C

LED Life / Failure Ratio

L70 B10 C0 252000h (at Tj 65 Ta 25)

UGR

UGR axial	15.6
UGR transversal	15.7
X=4H Y=8H	S=0.25H
Reflection factor	70/50/20

OPTICAL

C0/C180 optics	16°
Light distribution simmetry	Symmetrical

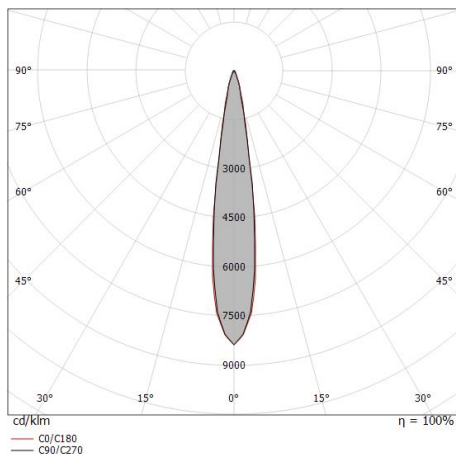

Distance [m]	Cone diameter [m]	illuminance [lx]
0.5	0.15 0.15	E(0°) 71940 E(C90) 8.1° 35132 E(C0) 8.3° 35143
1.0	0.28 0.29	E(0°) 17985 E(C90) 8.1° 8783 E(C0) 8.3° 8786
1.5	0.43 0.44	E(0°) 7993 E(C90) 8.1° 3904 E(C0) 8.3° 3905
2.0	0.57 0.58	E(0°) 4496 E(C90) 8.1° 2196 E(C0) 8.3° 2196
2.5	0.71 0.73	E(0°) 2878 E(C90) 8.1° 1405 E(C0) 8.3° 1406
3.0	0.85 0.88	E(0°) 1998 E(C90) 8.1° 976 E(C0) 8.3° 976

— C0/C180 (Half-peak divergence: 16.6°)
— C90/C270 (Half-peak divergence: 16.2°)

COLOR VECTOR GRAPHIC





Cob40_R | Downlights | Accessories
82473M15



Outer casing
installation position: ceiling; type of installation: masonry L=200mm, H=113mm, D=137mm.
Material:polypropylene, colour:white.

Code
89373

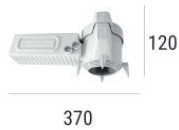

Outer casing
installation position: ceiling; type of installation: masonry L=370mm, H=120mm, D=200mm.
Material:polypropylene, colour:white.

Code
89374

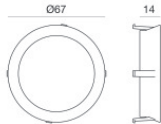

White decorative ring

Code
99901

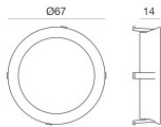

Decorative ring in gold color

Code
99902

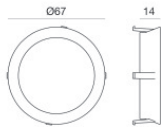

Decorative ring in copper color

Code
99903

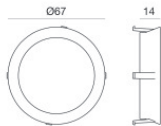

Chrome decorative ring

Code
99904