

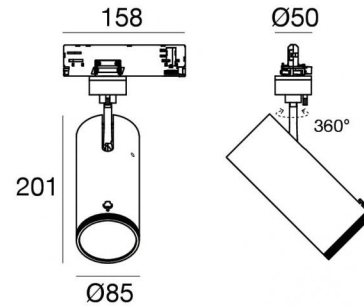

Projectors | 198-264 V  
1 arrayLED 32.5 W DC - 37 W AC | CRI 98  
**82449M85**



Technical data	
Type	Track
Installation position	Ceiling
Installation environment	Indoor
Light Source	LED
Circuit structure	arrayLED
Optics	Adjustable Focus
Light emission direction	frontal
Nominal power	32.5 W DC
Total Power	37 W
Source lumens	3266 lm
Nominal input voltage	220 - 240 V AC
Input voltage range	198 - 264 V AC
Frequency	50 - 60 Hz
CCT / Tone	2700 K
Colour rendering index	98 Ra
C.C. / C.V.	AC
Safety class	2
IP	IP20
Glow wire test	850°
Direct mounting on normally flammable surfaces	Yes
CE	Yes
Driver included	Driver
Dimmable article	Dimming on Board
Directional	Swivelling
total angle (vertical plane)	90 °
total angle (horizontal plane)	360 °
Tilting	No
Walk-over	No
Drive-over	No
Cable included	No
Resin potting	No
Type of light emission	Single emission
Net weight	0.92 Kg
Electrostatic discharge protection	Yes
Surge protection	2 KV

Finishing casing	
Material	Die-cast Aluminium EN AB - 46100
Colour	Black
Processing	Powder coating



Projectors | 198-264 V | 1 arrayLED 32.5 W DC - 37 W AC | CRI 98 | Angle Max  
82449M85

Single emission projectors for indoor application. The super warm white LED light source with a adjustable focus light distribution is composed of 1 arrayed LEDs with CCT of 2700 K and a CRI 98; the source luminous flux is 3266 lm, with a 100.5 lm/W nominal luminous efficacy.

The device body is made of die-cast aluminium en ab - 46100 and features a black finish, processed by means of powder coating. The ingress protection degree is IP20; the total weight is of 0.92 kg.

The total absorbed power is 37 W.

The device features protection class II and can be ceiling-mounted.

Compliant with the EN 60598-1 standard and its specific provisions.

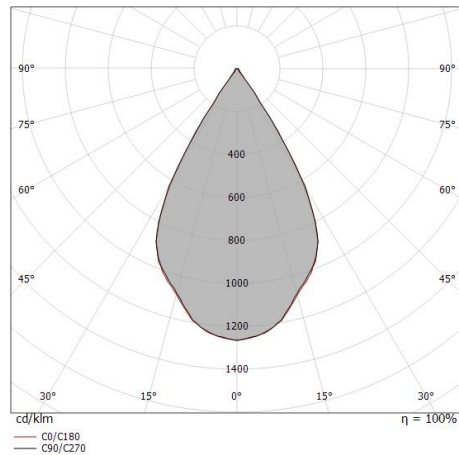

Distance [m]	Cone diameter [m]	illuminance [lx]
0.5	0.58 0.57	E(0°) 9812 E(C90) 29.9° 3208 E(C0) 29.7° 3237
1.0	1.15 1.14	E(0°) 2453 E(C90) 29.9° 802 E(C0) 29.7° 809
1.5	1.73 1.71	E(0°) 1090 E(C90) 29.9° 356 E(C0) 29.7° 360
2.0	2.30 2.28	E(0°) 613 E(C90) 29.9° 200 E(C0) 29.7° 202
2.5	2.88 2.85	E(0°) 392 E(C90) 29.9° 128 E(C0) 29.7° 129
3.0	3.45 3.42	E(0°) 273 E(C90) 29.9° 89 E(C0) 29.7° 90

— C0/C180 (Half-peak divergence: 59.4°)  
— C90/C270 (Half-peak divergence: 59.8°)

### Energy efficiency class

This product contains a light source of energy efficiency class G.

### Illuminotechnical Features

Light Output Ratio (LOR)	59 %
Source lumens	3266 lm
Delivered lumens	1940 lm
Consumption	37 W
Luminaire efficacy	52 lm/W
Colour temperature	2700 K
Standard Deviation of Colour Matching	2 Step MacAdam
Colour rendering index	98 Ra
Black Body Locus	On
Standard Operating Ambient Temperature	-20 / +50°C
Ordinary temperature on the glass	40°C

### LED Life / Failure Ratio

L70 B10 C0 252000h (at Tj 65 Ta 25)

### UGR

UGR axial	20.3
UGR transversal	20.2
X=4H   Y=8H	S=0.25H
Reflection factor	70/50/20

### OPTICAL

C0/C180 optics	59°
Light distribution simmetry	Symmetrical

### COLOR VECTOR GRAPHIC

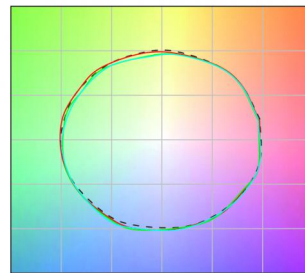



Projectors | 198-264 V | 1 arrayLED 32.5 W DC - 37 W AC | CRI 98 | Angle Min

## 82449M85

Single emission projectors for indoor application. The super warm white LED light source with a adjustable focus light distribution is composed of 1 arrayed LEDs with CCT of 2700 K and a CRI 98; the source luminous flux is 3266 lm, with a 100.5 lm/W nominal luminous efficacy.

The device body is made of die-cast aluminium en ab - 46100 and features a black finish, processed by means of powder coating. The ingress protection degree is IP20; the total weight is of 0.92 kg.

The total absorbed power is 37 W.

The device features protection class II and can be ceiling-mounted.

Compliant with the EN 60598-1 standard and its specific provisions.

### Energy efficiency class

This product contains a light source of energy efficiency class G.

### Illuminotechnical Features

Light Output Ratio (LOR)	28 %
Source lumens	3266 lm
Delivered lumens	930 lm
Consumption	37 W
Luminaire efficacy	25 lm/W
Colour temperature	2700 K
Standard Deviation of Colour Matching	2 Step MacAdam
Colour rendering index	98 Ra
Black Body Locus	On
Standard Operating Ambient Temperature	-20 / +50°C
Ordinary temperature on the glass	40°C

### LED Life / Failure Ratio

L70 B10 C0 252000h (at Tj 65 Ta 25 )

### UGR

UGR axial	10.9
UGR transversal	10.9
X=4H   Y=8H	S=0.25H
Reflection factor	70/50/20

### OPTICAL

C0/C180 optics	16°
Light distribution simmetry	Symmetrical

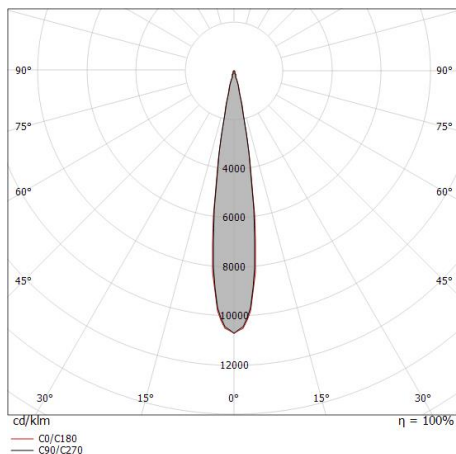

Distance [m]	Cone diameter [m]	illuminance [lx]
0.5	0.15 0.15	E(0°) 39810 E(C90) 19714 E(C0) 19316
1.0	0.29 0.30	E(0°) 9953 E(C90) 4929 E(C0) 4829
1.5	0.43 0.45	E(0°) 4423 E(C90) 2190 E(C0) 2146
2.0	0.58 0.60	E(0°) 2488 E(C90) 1232 E(C0) 1207
2.5	0.72 0.75	E(0°) 1592 E(C90) 789 E(C0) 773
3.0	0.86 0.90	E(0°) 1106 E(C90) 548 E(C0) 537

— C0/C180 (Half-peak divergence: 17.0°)  
— C90/C270 (Half-peak divergence: 16.4°)

### COLOR VECTOR GRAPHIC

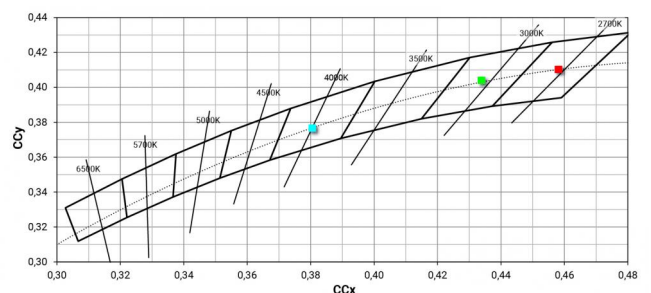
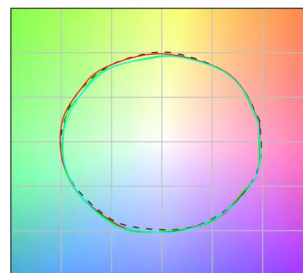

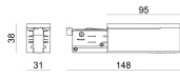

Power supply - White Right power supply header (9001/W)  
Material:PC, colour:white.

**Code**  
81033

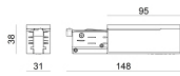

Power supply - White left power supply header (9002/W)  
Material:PC, colour:white.

**Code**  
81036



Power supply - Black left power supply header (9002/B)  
Material:PC, colour:black.

**Code**  
81037



Power supply - Black Right power supply header (9001/B)  
Material:PC, colour:black.

**Code**  
81034



Closing cap - White end cap 9004/W  
Material:PC, colour:white.

**Code**  
80999



Closing cap - Black end cap 9004/B  
Material:PC, colour:black.

**Code**  
81000



Closing cap - Recessed white end cap 9004-R/W  
Material:PC, colour:white.

**Code**  
81002



Closing cap - Recessed black end cap 9004-R/B  
Material:PC, colour:black.

**Code**  
81003



Closing cap - White gasket (S-9001/115-W)  
Material:white.

**Code**  
81084



Closing cap - Black gasket (S-9001/115-B)  
Material:black, colour:black.

**Code**  
81085



Ceiling rose - 1.5m white pendant luminaire kit + bracket (9000-KIT5-1,5-W)  
Material:plastic, colour:white.

**Code**  
81012



Ceiling rose - 1.5m black pendant luminaire kit + bracket ((9000-KIT5-1,5-B)  
Material:plastic, colour:black.

**Code**  
81014



Ceiling rose - 5m white pendant luminaire kit + bracket (9000-KIT5-5-W)  
Material:plastic, colour:white.

**Code**  
81013



Ceiling rose - 5m black pendant luminaire kit + bracket (9000-KIT5-5-B)  
Material:plastic, colour:black.

**Code**  
81015



Bracket - Anodized fixing bracket (S-9000/131)  
L=35mm, H=14mm, D=24mm.  
Material:Aluminium, colour:translucent.

**Finish**    **Code**  
Anod. Al.    81086



Bracket - Anodized stiffening bracket (S-9000/333)  
L=180mm, H=24mm, D=26mm.  
Material:Aluminium, colour:Anodised Aluminum, processing:Anodisation.

**Finish**    **Code**  
Anod. Al.    81024



		<p>Bracket - White stiffening bracket (S-9000/333-W) L=180mm, H=24mm, D=20mm. Material:Aluminium, colour:white RAL 9010, processing:Coating.</p>	<table border="1"> <thead> <tr> <th>Finish</th> <th>Code</th> </tr> </thead> <tbody> <tr> <td>White</td> <td>81025</td> </tr> </tbody> </table>	Finish	Code	White	81025
Finish	Code						
White	81025						
		<p>Bracket - Black stiffening bracket (S-9000/333-B) L=180mm, H=24mm, D=20mm. Material:Aluminium, colour:black RAL 9005, processing:Coating.</p>	<table border="1"> <thead> <tr> <th>Finish</th> <th>Code</th> </tr> </thead> <tbody> <tr> <td>Black</td> <td>81026</td> </tr> </tbody> </table>	Finish	Code	Black	81026
Finish	Code						
Black	81026						
		<p>Bracket - White fixing bracket (S-9000/131-W) L=35mm, H=14mm, D=24mm. Material:Aluminium, colour:white, processing:Coating.</p>	<table border="1"> <thead> <tr> <th>Finish</th> <th>Code</th> </tr> </thead> <tbody> <tr> <td>White</td> <td>81087</td> </tr> </tbody> </table>	Finish	Code	White	81087
Finish	Code						
White	81087						
		<p>Bracket - Black fixing bracket (S-9000/131-B) L=35mm, H=14mm, D=24mm. Material:Aluminium, colour:Black, processing:Coating.</p>	<table border="1"> <thead> <tr> <th>Finish</th> <th>Code</th> </tr> </thead> <tbody> <tr> <td>Black</td> <td>81088</td> </tr> </tbody> </table>	Finish	Code	Black	81088
Finish	Code						
Black	81088						
		<p>Junction - White electrical junction - internal (9003/W) Type linear. Material:PC, colour:white.</p>	<table border="1"> <thead> <tr> <th>Finish</th> <th>Code</th> </tr> </thead> <tbody> <tr> <td>White</td> <td>81039</td> </tr> </tbody> </table>	Finish	Code	White	81039
Finish	Code						
White	81039						
		<p>Junction - Black electrical junction - internal (9003/B) Type linear. Material:PC, colour:black.</p>	<table border="1"> <thead> <tr> <th>Finish</th> <th>Code</th> </tr> </thead> <tbody> <tr> <td>Black</td> <td>81040</td> </tr> </tbody> </table>	Finish	Code	Black	81040
Finish	Code						
Black	81040						
		<p>Junction - White power supply junction - central (9010/W) Type linear. Material:PC, colour:white.</p>	<table border="1"> <thead> <tr> <th>Finish</th> <th>Code</th> </tr> </thead> <tbody> <tr> <td>White</td> <td>81042</td> </tr> </tbody> </table>	Finish	Code	White	81042
Finish	Code						
White	81042						
		<p>Junction - White L junction - internal (9011/W) Type linear. Material:PC, colour:white.</p>	<table border="1"> <thead> <tr> <th>Finish</th> <th>Code</th> </tr> </thead> <tbody> <tr> <td>White</td> <td>81045</td> </tr> </tbody> </table>	Finish	Code	White	81045
Finish	Code						
White	81045						



		<p>Junction - White L junction - external (9012/W) Type linear. Material:PC, colour:white.</p>	<p><b>Finish</b> White</p>	<p><b>Code</b> 81048</p>
		<p>Junction - Flexible white junction (9018/W) Type flexible curve. Material:PC, colour:white.</p>	<p><b>Finish</b> White</p>	<p><b>Code</b> 81066</p>
		<p>Junction - White X junction (9017/W) Type linear. Material:PC, colour:white.</p>	<p><b>Finish</b> White</p>	<p><b>Code</b> 81063</p>
		<p>Junction - Left white T junction - external (9013/W) Type linear. Material:PC, colour:white.</p>	<p><b>Finish</b> White</p>	<p><b>Code</b> 81051</p>
		<p>Junction - Right white T junction - external (9014/W) Type linear. Material:PC, colour:white.</p>	<p><b>Finish</b> White</p>	<p><b>Code</b> 81054</p>
		<p>Junction - Left white T junction - internal (9015/W) Type linear. Material:PC, colour:white.</p>	<p><b>Finish</b> White</p>	<p><b>Code</b> 81057</p>
		<p>Junction - Right White T junction - internal (9016/W) Type linear. Material:PC, colour:white.</p>	<p><b>Finish</b> White</p>	<p><b>Code</b> 81060</p>
		<p>Junction - Black power supply junction - centrale (9010/B) Type linear. Material:PC, colour:black.</p>	<p><b>Finish</b> Black</p>	<p><b>Code</b> 81043</p>



		<p>Junction - Black L junction - internal (9011/B) Type linear. Material:PC, colour:black.</p>	<p><b>Finish</b> Black</p>	<p><b>Code</b> 81046</p>
		<p>Junction - Black L junction - external (9012/B) Type linear. Material:PC, colour:black.</p>	<p><b>Finish</b> Black</p>	<p><b>Code</b> 81049</p>
		<p>Junction - Flexible black junction (9018/B) Type flexible curve. Material:PC, colour:black.</p>	<p><b>Finish</b> Black</p>	<p><b>Code</b> 81067</p>
		<p>Junction - Black X junction (9017/B) Type linear. Material:PC, colour:black.</p>	<p><b>Finish</b> Black</p>	<p><b>Code</b> 81064</p>
		<p>Junction - Black left T junction - external (9013/B) Type linear. Material:PC, colour:black.</p>	<p><b>Finish</b> Black</p>	<p><b>Code</b> 81052</p>
		<p>Junction - Right black T junction - external (9014/B) Type linear. Material:PC, colour:black.</p>	<p><b>Finish</b> Black</p>	<p><b>Code</b> 81055</p>
		<p>Junction - Left black T junction - internal (9015/B) Type linear. Material:PC, colour:black.</p>	<p><b>Finish</b> Black</p>	<p><b>Code</b> 81058</p>
		<p>Junction - Right black T junction - internal (9016/B) Type linear. Material:PC, colour:black.</p>	<p><b>Finish</b> Black</p>	<p><b>Code</b> 81061</p>





Suspensions - 1.5m white pendant luminaires kit (9000-KIT3-1,5-W)  
Material:plastic, colour:white.

**Code**  
81006



Suspensions - 5m white pendant luminaires kit (9000-KIT3-5-W)  
Material:plastic, colour:white.

**Code**  
81007

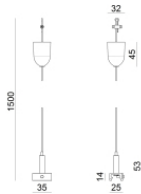

Suspensions - 1.5m black pendant luminaires kit (9000-KIT3-1,5-B)  
Material:plastic, colour:black.

**Code**  
81008

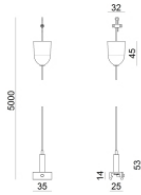

Suspensions - 5m black pendant luminaires kit (9000-KIT3-5-B)  
Material:plastic, colour:black.

**Code**  
81009



Suspensions - White rigid suspension clip (S-9000-P2-W)  
Material:plastic, colour:white.

**Code**  
81018



Suspensions - Black rigid suspension clip (S-9000-P2-B)  
Material:plastic, colour:black.

**Code**  
81019



Suspensions - White rigid suspension 1m (S-9000-P3-W)  
Material:plastic, colour:white.

**Code**  
81021



Suspensions - Black rigid suspension 1m (S-9000-P3-B)  
Material:plastic, colour:black.

**Code**  
81022



		<p>Cable cover - White recessed cover (S-9001-R/6-W) Material:PC, colour:white.</p>	<p><b>Code</b> <u>81069</u></p>
		<p>Cable cover - White cover for recessed junction (S-9010-R/6-W) Material:PC, colour:white.</p>	<p><b>Code</b> <u>81072</u></p>
		<p>Cable cover - White cover for recessed L junction (S-9011-R/6-W) Material:PC, colour:white.</p>	<p><b>Code</b> <u>81075</u></p>
		<p>Cable cover - White cover for recessed T junction (S-9013-R/6-W) Material:PC, colour:white.</p>	<p><b>Code</b> <u>81078</u></p>
		<p>Cable cover - White cover for recessed X junction (S-9017-R/6-W) Material:PC, colour:white.</p>	<p><b>Code</b> <u>81081</u></p>
		<p>Cable cover - Black recessed cover (S-9001-R/6-B) Material:PC, colour:black.</p>	<p><b>Code</b> <u>81070</u></p>
		<p>Cable cover - Black cover for recessed junction (S-9010-R/6-B) Material:PC, colour:black.</p>	<p><b>Code</b> <u>81073</u></p>
		<p>Cable cover Material:PC, colour:black.</p>	<p><b>Code</b> <u>81076</u></p>



		<p>Cable cover - Black cover for recessed T junction (S-9013-R/6-B) Material:PC, colour:black.</p>	<p><b>Code</b> <u>81079</u></p>
		<p>Cable cover - Black cover for recessed X junction (S-9017-R/6-B) Material:PC, colour:black.</p>	<p><b>Code</b> <u>81082</u></p>
		<p>Cable cover Material:white.</p>	<p><b>Code</b> <u>83249</u></p>
		<p>Cable cover Material:black, colour:black.</p>	<p><b>Code</b> <u>83250</u></p>
		<p>White three-phase/DALI adapter (9009/W)</p>	<p><b>Code</b> <u>81094</u></p>
		<p>White three-phase adapter (9009-4/W)</p>	<p><b>Code</b> <u>81091</u></p>
		<p>Black three-phase/DALI adapter (9009/B)</p>	<p><b>Code</b> <u>81095</u></p>
		<p>Black three-phase adapter (9009-4/B)</p>	<p><b>Code</b> <u>81093</u></p>



	Tool - Cutter S-9000/T	<b>Code</b>		
		81005		
		Track - Three-phase Recessed White DALI Track, 1 m (9000-1/W-R) Length: 1000mm; Type of track: Standard. Material:Aluminium, colour:White, processing:Coating.	<b>Finish</b>	<b>Code</b>
			White	80990
		Track - Three-phase Recessed White DALI Track, 2 m (9000-2/W-R) Length: 2000mm; Type of track: Standard. Material:Aluminium, colour:White, processing:Coating.	<b>Finish</b>	<b>Code</b>
			White	80991
		Track - Three-phase Recessed White DALI Track, 3 m (9000-3/W-R) Length: 3000mm; Type of track: Standard. Material:Aluminium, colour:White, processing:Coating.	<b>Finish</b>	<b>Code</b>
			White	80992
		Track - Three-phase Recessed Grey DALI Track, 1 m (9000-1/B-R) Length: 1000mm; Type of track: Standard. Material:Aluminium, colour:Black, processing:Coating.	<b>Finish</b>	<b>Code</b>
			Black	80993
		Track - Three-phase Recessed Black DALI Track, 2 m (9000-1/B-R) Length: 2000mm; Type of track: Standard. Material:Aluminium, colour:Black, processing:Coating.	<b>Finish</b>	<b>Code</b>
			Black	80994
		Track - Three-phase Recessed Black DALI Track, 3 m (9000-3/B-R) Length: 3000mm; Type of track: Standard. Material:Aluminium, colour:Black, processing:Coating.	<b>Finish</b>	<b>Code</b>
			Black	80995
		Track Length: 1000mm; Type of track: Standard. Material:Aluminium, colour:White, processing:Coating.	<b>Finish</b>	<b>Code</b>
			White	83336



		<p>Track Length: 2000mm; Type of track: Standard. Material:Aluminium, colour:White, processing:Coating.</p>	<table border="1"> <thead> <tr> <th>Finish</th> <th>Code</th> </tr> </thead> <tbody> <tr> <td>White</td> <td>83337</td> </tr> </tbody> </table>	Finish	Code	White	83337
Finish	Code						
White	83337						
		<p>Track Length: 3000mm; Type of track: Standard. Material:Aluminium, colour:White, processing:Coating.</p>	<table border="1"> <thead> <tr> <th>Finish</th> <th>Code</th> </tr> </thead> <tbody> <tr> <td>White</td> <td>83338</td> </tr> </tbody> </table>	Finish	Code	White	83338
Finish	Code						
White	83338						
		<p>Track Length: 1000mm; Type of track: Standard. Material:Aluminium, colour:Black, processing:Coating.</p>	<table border="1"> <thead> <tr> <th>Finish</th> <th>Code</th> </tr> </thead> <tbody> <tr> <td>Black</td> <td>83339</td> </tr> </tbody> </table>	Finish	Code	Black	83339
Finish	Code						
Black	83339						
		<p>Track Length: 2000mm; Type of track: Standard. Material:Aluminium, colour:Black, processing:Coating.</p>	<table border="1"> <thead> <tr> <th>Finish</th> <th>Code</th> </tr> </thead> <tbody> <tr> <td>Black</td> <td>83340</td> </tr> </tbody> </table>	Finish	Code	Black	83340
Finish	Code						
Black	83340						
		<p>Track Length: 3000mm; Type of track: Standard. Material:Aluminium, colour:Black, processing:Coating.</p>	<table border="1"> <thead> <tr> <th>Finish</th> <th>Code</th> </tr> </thead> <tbody> <tr> <td>Black</td> <td>83341</td> </tr> </tbody> </table>	Finish	Code	Black	83341
Finish	Code						
Black	83341						