

# Pound\_Wall

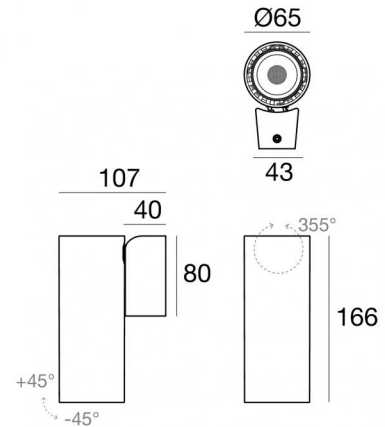

Wall Lights | 100-264 V | 1 arrayLED 17.5 W DC - 19.5 W AC | CRI 90  
81997W15



Technical data	
Type	Surface
Installation position	Wall lights
Installation environment	Indoor
Light Source	LED
Circuit structure	arrayLED
Optics	Spot
Light emission direction	downward
Nominal power	17.5 W DC
Total Power	19.5 W
Source lumens	2818 lm
Nominal input voltage	220 - 240 V AC
Input voltage range	100 - 264 V AC
Frequency	50 - 60 Hz
CCT / Tone	3000 K
Colour rendering index	90 Ra
C.C. / C.V.	AC
Safety class	1
IP	IP20
Glow wire test	850°
Direct mounting on normally flammable surfaces	Yes
CE	Yes
Driver included	Driver
Dimmable article	No
Directional	Swivelling
total angle (vertical plane)	90 °
total angle (horizontal plane)	355 °
Tilting	No
Walk-over	No
Drive-over	No
Cable included	No
Resin potting	No
Type of light emission	Single emission
Net weight	0.8 Kg
Electrostatic discharge protection	Yes
Surge protection	1.85 KV
Optics technology	Anti - Glare

Finishing casing	
Material	Die-cast Aluminium EN AB - 46100
Colour	White
Processing	Powder coating



Wall Lights | 100-264 V | 1 arrayLED 17.5 W DC - 19.5 W AC | CRI 90 | Base 81997W15

Single emission wall lights for indoor application. The warm white LED light source with a spot light distribution is composed of 1 arrayed LEDs with CCT of 3000 K and a CRI 90; the source luminous flux is 2818 lm, with a 161.0 lm/W nominal luminous efficacy.

The device body is made of die-cast aluminium en ab - 46100 and features a white finish, processed by means of powder coating. The ingress protection degree is IP20; the total weight is of 0.8 kg.

The total absorbed power is 19.5 W.

The device features protection class I and can be wall lights-mounted.

Compliant with the EN 60598-1 standard and its specific provisions.

### Energy efficiency class

This product contains a light source of energy efficiency class E.

### Illuminotechnical Features

Light Output Ratio (LOR)	69 %
Source lumens	2818 lm
Delivered lumens	1964 lm
Consumption	19.5 W
Luminaire efficacy	100 lm/W
Colour temperature	3000 K
Standard Deviation of Colour Matching	2 Step MacAdam
Colour rendering index	90 Ra
Colour Rendering Index	60 R9
Black Body Locus	On
Standard Operating Ambient Temperature	-20 / +50°C
Ordinary temperature on the glass	40°C

### LED Life / Failure Ratio

L70 B10 C0 252000h (at Tj 65 Ta 25 )

### UGR

UGR axial	17.2
UGR transversal	17.2
X=4H   Y=8H	S=0.25H
Reflection factor	70/50/20

### OPTICAL

C0/C180 optics	19°
Light distribution simmetry	Symmetrical

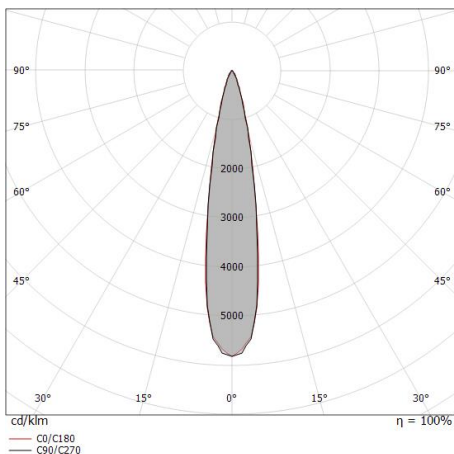







Distance [m]	Cone diameter [m]	Illuminance [lx]	E(0°)	E(C90)	E(C0)
0.5	0.17 0.17	45732	9.7° 21955	9.8° 21929	
1.0	0.34 0.35	11433	9.7° 5489	9.8° 5482	
1.5	0.51 0.52	5081	9.7° 2439	9.8° 2437	
2.0	0.68 0.69	2858	9.7° 1372	9.8° 1371	
2.5	0.85 0.86	1829	9.7° 878	9.8° 877	
3.0	1.03 1.04	1270	9.7° 610	9.8° 609	

— C0/C180 (Half-peak divergence: 19.6°)  
— C90/C270 (Half-peak divergence: 19.4°)

### COLOR VECTOR GRAPHIC





	<p>Diffuser Diffuser Type: elliptical filter. Material:Pom-C, colour:Black.</p>	<p><b>Code</b> <u>99781</u></p>
	<p>Anti-glare Anti-glare Type: honeycomb louvre. Material:Pom-C, colour:Black.</p>	<p><b>Code</b> <u>99780</u></p>
	<p>Anti-glare Anti-glare Type: cross louvres. Material:Pom-C, colour:Black.</p>	<p><b>Code</b> <u>99779</u></p>
	<p>Anti-glare Anti-glare Type: 45° cylindrical screen. Material:Pom-C, colour:Black.</p>	<p><b>Code</b> <u>99782</u></p>
	<p>Optics Light distribution: spot,Cover material: uv resistant polycarbonate</p>	<p><b>Code</b> <u>99827</u></p>
	<p>Optics Light distribution: medium flood,Cover material: ,uv resistant polycarbonate,uv resistant polycarbonate,uv resistant polycarbonate</p>	<p><b>Code</b> <u>99828</u></p>
	<p>Optics Light distribution: flood,Cover material: ,uv resistant polycarbonate,uv resistant polycarbonate,uv resistant polycarbonate</p>	<p><b>Code</b> <u>99829</u></p>