

# Prolamp RGBW

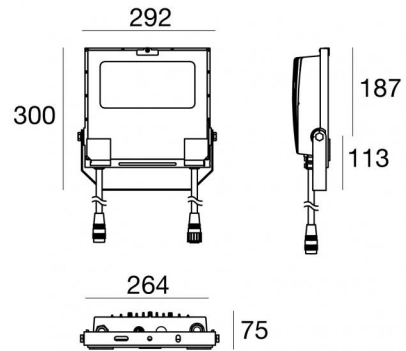

Projectors | 8 x powerLEDs 59 W DC 48 V  
RGBW - 3000  
81949V30



Technical data	
Type	Surface
Installation position	Wall lights - Ceiling - Floor
Installation environment	Outdoor
Light Source	LED
Circuit structure	powerLEDs
Optics	Medium Flood
Light emission direction	frontal
Nominal power	59 W DC
CCT / Tone	RGBW - 3000 K
C.C. / C.V.	CV
Safety class	3
IP	IP67
IK	IK08
Glow wire test	850°
Direct mounting on normally flammable surfaces	Yes
CE	Yes
Driver included	Control unit
Dimmable article	DMX-RDM
Directional	Swivelling
total angle (vertical plane)	180 °
Tilting	No
Walk-over	No
Drive-over	No
Cable included	Yes
Cable length	0.3 m
Resin potting	No
Type of light emission	Single emission
Net weight	3.8 Kg
Electrostatic discharge protection	Yes
Surge protection	4 KV
Product technological characteristics	TCS

## Finishing casing

Material	Die-cast Aluminium EN AB - 46100
Colour	Black
Processing	Open pore anodizing + Powder Coating

## Finishing diffuser

Material	Extra clear glass - Tempered
Colour	transparent
Processing	Silk-screening

## Finishing bracket

Material	AISI 304 steel
Colour	steel

## Electronics

	99785 On/Off Driver 100~305V AC / 142~431V DC 240 W (1 - 4 art.)
---	---

	C-E700026 DMX Controller (1 art.)
---	--------------------------------------

## Cables Electrification+signal

IP (locked condition)	67
Cable connector	AllinONE Male Plug 6 Pin
Cable connector	ALLinONE Female Socket 6 Pin

## Lumen RGBW

N. Led	Red	Green	Blue	white
8	592 lm	968 lm	168 lm	976 lm

# Prolamp RGBW



Projectors | 8 x powerLEDs 59 W DC 48 V | RGBW - 3000  
**81949V30**

Single emission projectors for outdoor application. The RGBW - 3000 K LED light source with a medium flood light distribution is composed of 8 powered LEDs with CCT of RGB-W 3000 K.

The device body is made of die-cast aluminium en ab - 46100 and features a black finish, processed by means of open pore anodizing + powder coating; the diffuser is made of extra clear glass - tempered with a silk-screening treatment. The ingress protection degree is IP67; the total weight is of 3.8 kg.

The total absorbed power is 59 W. The power supply cable is included and features a 0.3 m length.

The device features protection class III and can be wall lights, ceiling or floor-mounted.

Compliant with the EN 60598-1 standard and its specific provisions.

## Energy efficiency class

This product contains a light source of energy efficiency class G.









Standard Operating Ambient Temperature	-20 / +50°C
--	-------------

Ordinary temperature on the glass	40°C
-----------------------------------	------

## LED Life / Failure Ratio

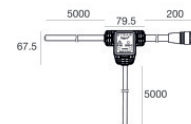
L70 B10 C0 202460h (at Tj 60 Ta 25 )

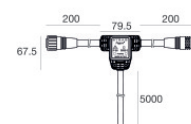

<p><b>L. 1m</b></p> 	<p>Cable and connector Type of cable power + signal cable allinone; Length 1000 mm; insulation double with shielding for signal; external diameter: 12.6 mm; colors: white - blue - red - grey - brown - yellow-green.</p>	<p><b>Code</b> <u>98660</u></p>
<p><b>L. 5m</b></p> 	<p>Cable and connector Type of cable power + signal cable allinone; Length 5000 mm; insulation double with shielding for signal; external diameter: 12.6 mm; colors: white - blue - red - grey - brown - yellow-green.</p>	<p><b>Code</b> <u>98661</u></p>
<p><b>L. 1m</b></p> 	<p>Cable and connector Type of cable power + signal cable allinone; Length 1000 mm; insulation double with shielding for signal; external diameter: 12.6 mm.</p>	<p><b>Code</b> <u>98662</u></p>
<p><b>L. 5m</b></p> 	<p>Cable and connector Type of cable power + signal cable allinone; Length 5000 mm; insulation double with shielding for signal; external diameter: 12.6 mm.</p>	<p><b>Code</b> <u>98663</u></p>
 	<p>Connector - Start splitter Type of cable power + signal cable allinone; Length 5000 + 5000 + 200 mm; insulation double with shielding for signal.</p>	<p><b>Code</b> <u>98985</u></p>
 	<p>Connector - Continuity splitter Type of cable power + signal cable allinone; Length 200 + 200 + 5000 mm; insulation double with shielding for signal.</p>	<p><b>Code</b> <u>99390</u></p>
	<p>Connector - DMX line closure adapter for ALLinONE cables Type of cable power + signal cable allinone; ; insulation double with shielding for signal.</p>	<p><b>Code</b> <u>98986</u></p>