

Archiline_W PRO

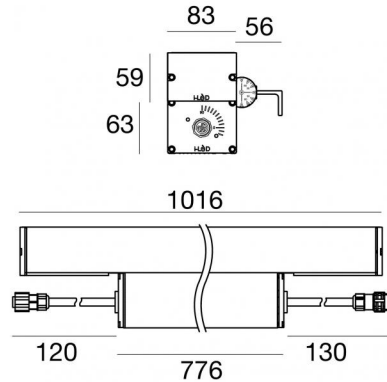

Wall Lights - Lines | 220-240 V AC /180-275 V DC
18 x powerLEDs 74 W DC - 86 W AC | RGBW - 4000
81452Q06



Technical data	
Type	- - Surface
Installation position	Wall lights - Ceiling
Installation environment	Outdoor
Light Source	LED
Circuit structure	powerLEDs
Optics	Ultra Spot
Light emission direction	upward
Nominal power	74 W DC
Total Power	86 W
Input voltage range	220 - 240 V AC
Frequency	50 - 60 Hz
CCT / Tone	RGBW - 4000 K
C.C. / C.V.	AC
Safety class	1
IP	IP67
IK	IK08
Glow wire test	850°
Direct mounting on normally flammable surfaces	Yes
CE	Yes
Driver included	Control unit/Driver
Dimmable article	DMX-RDM
Directional	Swivelling
total angle (vertical plane)	135 °
Tilting	No
Walk-over	No
Drive-over	No
Cable included	Yes
Cable length	0.17 m
Resin potting	No
Type of light emission	Single emission
Net weight	6.2 Kg
Electrostatic discharge protection	Yes
Surge protection	4 KV
Optics technology	Dark light
Product technological characteristics	TCS - TVS

Finishing casing

Material	Aluminium 6060
Colour	Anodised Aluminum
Processing	20 µm anodizing

Finishing diffuser

Material	Extra clear glass - Tempered
Colour	transparent
Processing	Silk-screening

Finishing bracket

Material	Aluminium 6060
Colour	Anodised Aluminum
Processing	20 µm anodizing

Cables Electrification+signal

Cable connector	AllinONE Male Plug 6 Pin
IP (locked condition)	67

Cable connector	ALLinONE Female Socket 6 Pin
-----------------	------------------------------

Lumen RGBW

N. Led	Red	Green	Blue	white
18	702 lm	1404 lm	216 lm	1566 lm



Wall Lights - Lines | 220-240 V AC /180-275 V DC | 18 x powerLEDs 74 W DC - 86 W AC |
RGBW - 4000
81452Q06

Single emission wall lights or lines for outdoor application. The RGBW - 4000 K LED light source with a ultra spot light distribution is composed of 18 powerled LEDs with CCT of RGB-W 4000 K.

The device body is made of aluminium 6060 and features a anodised aluminum finish, processed by means of 20 µm anodizing; the diffuser is made of extra clear glass - tempered with a silk-screening treatment. The ingress protection degree is IP67; the total weight is of 6.2 kg.

The total absorbed power is 74 W. The power supply cable is included and features a 0.17 m length.

The device features protection class I and can be wall lights or ceiling-mounted.

Compliant with the EN 60598-1 standard and its specific provisions.

Energy efficiency class

This product contains 6 light sources of energy efficiency class G.









Standard Operating Ambient Temperature	-20 / +50°C
--	-------------

Ordinary temperature on the glass	40°C
-----------------------------------	------

LED Life / Failure Ratio

L70 B10 C0 202460h (at Tj 60 Ta 25)

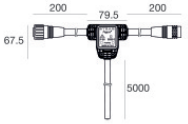

<p>L. 1m</p> 	<p>Cable and connector Type of cable power + signal cable allinone; Length 1000 mm; insulation double with shielding for signal; external diameter: 12.6 mm; colors: white - blue - red - grey - brown - yellow-green.</p>	<p>Code <u>98660</u></p>
<p>L. 5m</p> 	<p>Cable and connector Type of cable power + signal cable allinone; Length 5000 mm; insulation double with shielding for signal; external diameter: 12.6 mm; colors: white - blue - red - grey - brown - yellow-green.</p>	<p>Code <u>98661</u></p>
<p>L. 1m</p> 	<p>Cable and connector Type of cable power + signal cable allinone; Length 1000 mm; insulation double with shielding for signal; external diameter: 12.6 mm.</p>	<p>Code <u>98662</u></p>
<p>L. 5m</p> 	<p>Cable and connector Type of cable power + signal cable allinone; Length 5000 mm; insulation double with shielding for signal; external diameter: 12.6 mm.</p>	<p>Code <u>98663</u></p>
 	<p>Connector - Start splitter Type of cable power + signal cable allinone; Length 5000 + 5000 + 200 mm; insulation double with shielding for signal.</p>	<p>Code <u>98985</u></p>
 	<p>Connector - Continuity splitter Type of cable power + signal cable allinone; Length 200 + 200 + 5000 mm; insulation double with shielding for signal.</p>	<p>Code <u>99390</u></p>
	<p>Connector - DMX line closure adapter for ALLinONE cables Type of cable power + signal cable allinone; ; insulation double with shielding for signal.</p>	<p>Code <u>98986</u></p>