

Navata Pound Shaper

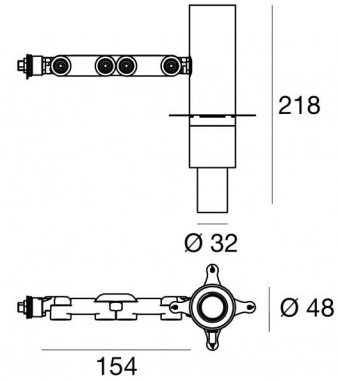

Projectors | 1 arrayLED 11 W DC 300 mA | CRI 98
76744N66











Technical data	
Type	Surface
Installation position	Wall lights - Ceiling - Floor
Installation environment	Indoor
Light Source	LED
Circuit structure	arrayLED
Optics	Shaper Short Distance
Light emission direction	frontal
Nominal power	11 W DC
Source lumens	1182 lm
Input voltage range	300mA
CCT / Tone	4000 K
Colour rendering index	98 Ra
C.C. / C.V.	CC
Safety class	3
IP	IP20
Glow wire test	850°
Direct mounting on normally flammable surfaces	Yes
CE	Yes
Driver included	No
Dimmable article	DALI - 1-10V
Directional	Swivelling
total angle (vertical plane)	90 °
total angle (horizontal plane)	360 °
Tilting	No
Walk-over	No
Drive-over	No
Cable included	No
Resin potting	No
Type of light emission	Single emission
Net weight	0.5 Kg
Electrostatic discharge protection	No
Surge protection	No

Finishing casing

Material	Die-cast Aluminium EN AB - 46100
Colour	Sand
Processing	Powder coating

Electronics

	99734 Multi Power 198~264V AC / 180~275V DC (1 art.)
	99730 DALI - Push and Simply Dim Multi Power 198~264V AC / 180~275V DC (1 art.)
	83054 DALI-2 Controller (1 - 2 art.)
	83055 Multi Power 198~264V AC / 176~264V DC (1 - 2 art.)
	83051 DALI Multi Power 198~264V AC / 176~275V DC (1 art.)
	83052 Multi Power 198~264V AC / 176~264V DC (1 art.)
	83053 Bluetooth Controller (1 art.)
	C-E100006 Multi Power 198~264V AC / 180~275V DC (1 art.)

Navata Pound Shaper



Projectors | 1 arrayLED 11 W DC 300 mA | CRI 98 | Base
76744N66

Single emission projectors for indoor application. The natural white LED light source with a shaper short distance light distribution is composed of 1 arrayed LEDs with CCT of 4000 K and a CRI 98; the source luminous flux is 1182 lm, with a 107.5 lm/W nominal luminous efficacy.

The device body is made of die-cast aluminium en ab - 46100 and features a sand finish, processed by means of powder coating. The ingress protection degree is IP20; the total weight is of 0.5 kg. The power supply driver is not provided and is to be ordered separately.

The total absorbed power is 11 W.

The device features protection class III and can be wall lights, ceiling or floor-mounted.

Compliant with the EN 60598-1 standard and its specific provisions.

Energy efficiency class

This product contains a light source of energy efficiency class F.

Illuminotechnical Features

Light Output Ratio (LOR)	13 %
Source lumens	1182 lm
Delivered lumens	159 lm
Consumption	11 W
Luminaire efficacy	14 lm/W
Colour temperature	4000 K
Standard Deviation of Colour Matching	2 Step MacAdam
Colour rendering index	98 Ra
Black Body Locus	On
Standard Operating Ambient Temperature	-20 / +50°C
Ordinary temperature on the glass	45°C

LED Life / Failure Ratio

L70 B10 C0 252000h (at Tj 65 Ta 25)

UGR

UGR axial	-8.2
UGR transversal	-8.2
X=4H Y=8H	S=0.25H
Reflection factor	70/50/20

OPTICAL

C0/C180 optics	35°
Light distribution simmetry	Symmetrical

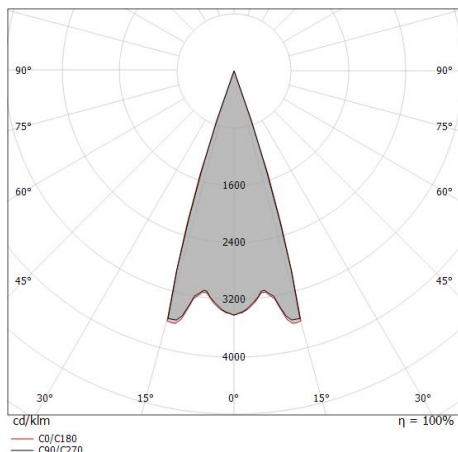

Distance [m]	Cone diameter [m]	illuminance [lx]
0.5	0.32 0.32	E(0°) 2165 E(C90) 17.5° 1005 E(C0) 17.6° 1001
1.0	0.63 0.63	E(0°) 541 E(C90) 17.5° 251 E(C0) 17.6° 250
1.5	0.95 0.95	E(0°) 241 E(C90) 17.5° 112 E(C0) 17.6° 111
2.0	1.26 1.27	E(0°) 135 E(C90) 17.5° 63 E(C0) 17.6° 63
2.5	1.58 1.59	E(0°) 87 E(C90) 17.5° 40 E(C0) 17.6° 40
3.0	1.89 1.90	E(0°) 60 E(C90) 17.5° 28 E(C0) 17.6° 28

Distance [m] Cone diameter [m] illuminance [lx]

— C0/C180 (Half-peak divergence: 35.2°)
— C90/C270 (Half-peak divergence: 35.0°)

COLOR VECTOR GRAPHIC

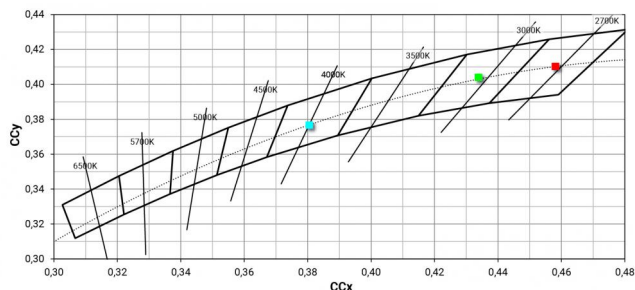
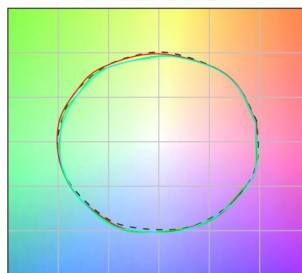

Navata Pound Shaper



Navata Pound Shaper | Projectors | Accessories
76744N66

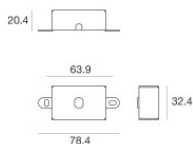

Fixing base - Base without power supply
Material:Iron, colour:Sand, processing:Coating.

Code

83242