

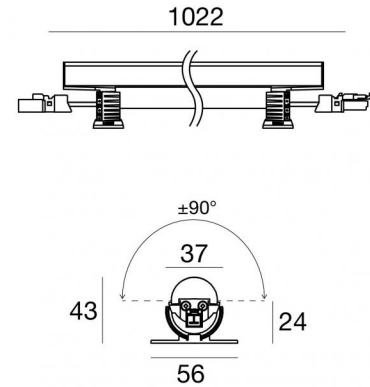

Lineare Elemente | 147 topLED 27 W DC 24 V  
CRI 80  
**94115N00**



Technische Daten	
Typ	Oberfläche
Installationsposition	Wand - Decke - Boden
Installationsumgebung	Indoor
Lichtquelle	LED
Circuit structure	topLED
Optik	Diffuses
Light emission direction	upward
Lampe Nennleistung	27 W DC
Lichtstrom (Lichtquelle)	3276 lm
Ähnlichste Farbtemperatur / Tone	4000 K
Farbwiedergabeindex	80 Ra
Gleichstrom/Gleichspannung	CV
Isolierklasse	3
IP	IP40
IK	IK08
Glühdrahtprüfung	850°
Direkte Montage auf normal entflammaren Oberflächen	Ja
CE	Ja
Einschließlich Driver	Nein
Leuchte dimmbar	DALI - 1-10V
Schwenkbarkeit	Orientabile
Gesamtwinkel (vertikale Ebene)	180 °
Drehbarkeit	Nein
Begehbarkeit	Nein
Überrollbarkeit	Nein
Einschließlich Kabel	Ja
Kabellänge	0.02 m
Harzbeschichtung	Nein
Typ Lichtabstrahlung	Einflammig
Nettogewicht	0.435 Kg
Schutz vor elektrostatischen Entladungen	Nein
Schutz vor Stoßspannungen	Nein
Technische Merkmale des Produkts	UV Resistant

### Oberfläche Gehäuse

Material	Aluminium 6060
Farbe	Eloxiertes Aluminium
Bearbeitungstyp	Anodisierung 20 µm

### Oberfläche Diffusor

Material	Polycarbonat UV-beständige
----------	----------------------------

### Oberfläche bügel

Material	Polycarbonat UV-beständige
Farbe	transparent

### Elektronik

	99331 On/Off Driver 198~264V AC / 176~275V DC 150 W (1 - 5 art.)
---	---

	99332 1-10V Controller (1 - 5 art.)
---	--

	99374 On/Off Driver 198~264V AC / 176~275V DC 75 W (1 - 2 art.)
---	--

	83333 Push and Simply Dim - DALI-2 Controller (1 - 5 art.)
---	---

	C-E400002 Push and Simply Dim - DALI-2 Controller (1 - 8 art.)
---	---

### Cables Electrification

Cable connector	Male Plug 2 Pin
-----------------	-----------------

Cable connector	Female Socket 2 Pin
-----------------	---------------------

## Lineare Elemente | 147 topLED 27 W DC 24 V | CRI 80 94115N00

Single emission lines for indoor application. The natural white LED light source with a diffused light distribution is composed of 147 topLEDs with CCT of 4000 K and a CRI 80; the source luminous flux is 3276 lm, with a 121.3 lm/W nominal luminous efficacy.

The device body is made of aluminium 6060 and features a anodised aluminum finish, processed by means of 20 µm anodizing; the diffuser is made of uv resistant polycarbonate. The ingress protection degree is IP40; the total weight is of 0.435 kg. The power supply driver is not provided and is to be ordered separately.

The total absorbed power is 27 W. The power supply cable is included and features a 0.02 m length.

The device features protection class III and can be wall lights, ceiling or floor-mounted.

Compliant with the EN 60598-1 standard and its specific provisions.

### Energieeffizienzklasse

Dieses Produkt enthält 3 Lichtquellen der Energieeffizienzklasse D.

### Illuminotechnical Eigenschaften

Light Output Ratio (LOR)	79 %
Lichtstrom (Lichtquelle)	3276 lm
Leuchten Lichtstrom	2596 lm
Consumption	27 W
Leuchten Lichtausbeute	96 lm/W
Farbtemperatur	4000 K
Standard Deviation of Colour Matching	3 Step MacAdam
Farbwiedergabeindex	80 Ra
Standardumgebungstemperatur	-20 / +50°C
Typische Temperatur am Glas	40°C

### LED Life / Failure Ratio

L70 B10 C0 145770h (at Tj 65 Ta 25 )

### UGR

UGR axial	30.2
UGR transversal	34.4
X=4H   Y=8H	S=0.25H
Reflection factor	70/50/20

### OPTICAL

Optik C90/C270	105°
Optik C0/C180	126°
Light distribution simmetry	Symmetrical 2 assis

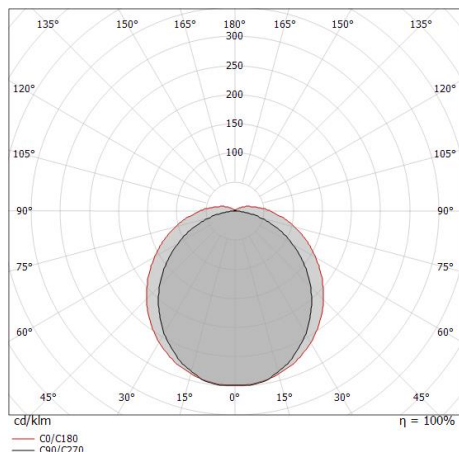

Distance [m]	Cone diameter [m]	illuminance [lx]
0.5	1.29 1.95	E(0°) 3107 E(C90) 357 E(C0) 147
1.0	2.59 3.91	E(0°) 777 E(C90) 89 E(C0) 37
1.5	3.88 5.86	E(0°) 345 E(C90) 40 E(C0) 16
2.0	5.18 7.82	E(0°) 194 E(C90) 22 E(C0) 9
2.5	6.47 9.77	E(0°) 124 E(C90) 14 E(C0) 6
3.0	7.76 11.73	E(0°) 86 E(C90) 10 E(C0) 4

— C0/C180 (Half-peak divergence: 125.8°)  
— C90/C270 (Half-peak divergence: 104.6°)



Kabel und Stecker

Länge 250 mm; isolierung einzeln; querschnitt 1.5 mm<sup>2</sup>; außendurchmesser: 2x3,4 mm;  
farben: schwarz - rot.

**Code**

98879



Kabel und Stecker

Länge 1000 mm; isolierung einzeln; querschnitt 1.5 mm<sup>2</sup>; außendurchmesser: 2x3,4 mm;  
farben: schwarz - rot.

**Code**

98878



Klammer

L=975mm, H=3mm, D=56mm.

Material:Eisen, farbe:Zink, bearbeitungstyp :Verzinken.

**Finish**

Grey

**Code**

98781