

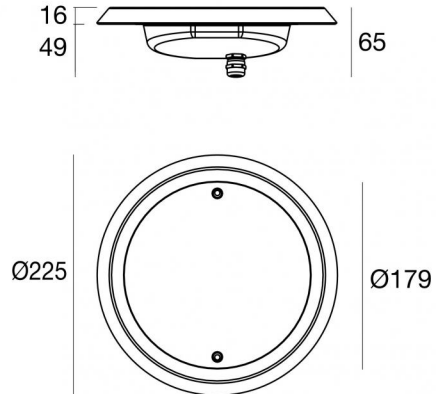

Unterwasserleuchten | 9 x powerLEDs 38 W DC 700 mA
 RGBW - 4000
84044Q25



Technische Daten	
Typ	Frame
Installationsposition	Wand - Boden
Installationsumgebung	Outdoor
Lichtquelle	LED
Circuit structure	powerLEDs
Optik	Elliptic Medium Flood
Light emission direction	frontal
Lampe Nennleistung	38 W DC
Eingangsspannungsbereich	700mA
Ähnlichste Farbtemperatur / Tone	RGBW - 4000 K
Gleichstrom/Gleichspannung	CC
Isolierklasse	3
IP	IP68
Maximale Einbautiefe	25 mm
Installationsbeschränkung	Nur unter Wasser
IK	IK10
Glühdrahtprüfung	850°
Direkte Montage auf normal entflammaren Oberflächen	Ja
CE	Ja
Einschließlich Driver	Nein
Leuchte dimmbar	Ja
Schwenkbarkeit	Nein
Drehbarkeit	Nein
Begehbarkeit	Nein
Überrollbarkeit	Nein
Einschließlich Kabel	Ja
Kabellänge	5 m
Harzbeschichtung	Ja
Typ Lichtabstrahlung	Einflammig
Nettogewicht	0.8 Kg
Schutz vor elektrostatischen Entladungen	Nein
Schutz vor Stoßspannungen	Nein
Technische Merkmale des Produkts	Acquastop

Oberfläche Gehäuse

Material	Stahl AISI 316L
Farbe	Stahl

Oberfläche Diffusor

Material	Extra-helles Glas - Gehärtet
Farbe	transparent
Bearbeitungstyp	Siebdruck

Oberfläche flansch

Material	Edelstahl 316
Farbe	Stahl
Bearbeitungstyp	Elektropolierbad

Elektronik

	83010 On/Off Driver 90~264V AC / 127~370V DC 60 W (1 art.)
---	---

	83187 Push and Simply Dim - DMX-RDM Multi Channel 4ch. 10.8~52.8V DC (1 art.)
---	--

Lumen RGBW

N. Led	Rot	Grün	Blau	Weiß
9	261 lm	675 lm	216 lm	783 lm



Unterwasserleuchten | 9 x powerLEDs 38 W DC 700 mA | RGBW - 4000
84044Q25

Single emission submerged for outdoor application. The RGBW - 4000 K LED light source with a elliptic medium flood light distribution is composed of 9 powerled LEDs with CCT of RGB-W 4000 K.

The device body is made of aisi 316l steel and features a steel finish; the diffuser is made of extra clear glass - tempered with a silk-screening treatment. The ingress protection degree is IP68; the total weight is of 0.8 kg. The power supply driver is not provided and is to be ordered separately.

The total absorbed power is 38 W. The power supply cable is included and features a 5 m length.

The device features protection class III and can be wall lights or floor-mounted with an outer casing, code 83198(for concrete or masonry).

Compliant with the EN 60598-1 standard and its specific provisions.

Standardumgebungstemperatur	-20 / +50°C
Typische Temperatur am Glas	40°C



Nautilus_R | Submerged | Accessories
84044Q25

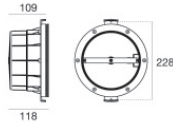

Einbaugehäuse - Außengehäuse zur Installation auf Leinwand
installationsposition: wand; typ installation: mauerwerk L=213mm, H=213mm, D=110mm.
Material:Kunststoff ABS, farbe:Schwarz.

Code
83198

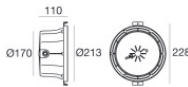
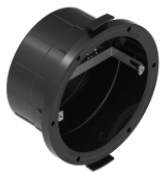

Einbaugehäuse - Gehäuse IP68 zur Montage auf Mauerwerk (Fliesen oder Mosaik)
installationsposition: wand; typ installation: mauerwerk L=213mm, H=213mm, D=110mm.
Material:Kunststoff ABS, farbe:Schwarz.

Code
83142

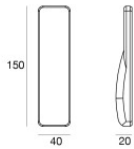

Remote RF

Code
C-W600001

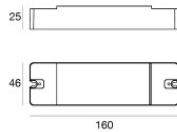

Dimmer
RF Remote controller

Code
C-E700003