

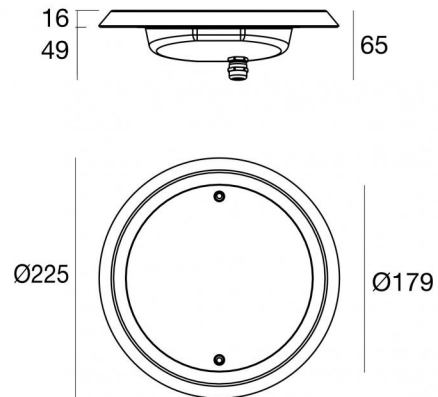

Unterwasserleuchten | 9 x powerLEDs 38 W DC 12 V
CRI 80
84042N31



Technische Daten	
Typ	Frame
Installationsposition	Wand - Boden
Installationsumgebung	Outdoor
Lichtquelle	LED
Circuit structure	powerLEDs
Optik	Mix Flux 1 Asymmetric + Elliptic
Light emission direction	frontal
Lampe Nennleistung	38 W DC
Lichtstrom (Lichtquelle)	4921 lm
Ähnlichste Farbtemperatur / Tone	4000 K
Farbwiedergabeindex	80 Ra
Gleichstrom/Gleichspannung	CV
Isolierklasse	3
IP	IP68
Maximale Einbautiefe	25 m
Installationsbeschränkung	Nur unter Wasser
IK	IK10
Glühdrahtprüfung	850°
Direkte Montage auf normal entflammaren Oberflächen	Ja
CE	Ja
Einschließlich Driver	Nein
Leuchte dimmbar	DALI - 1-10V
Schwenkbarkeit	Nein
Drehbarkeit	Nein
Begehbarkeit	Nein
Überrollbarkeit	Nein
Einschließlich Kabel	Ja
Kabellänge	5 m
Harzbeschichtung	Ja
Typ Lichtabstrahlung	Einflammig
Nettogewicht	0.8 Kg
Schutz vor elektrostatischen Entladungen	Nein
Schutz vor Stoßspannungen	Nein
Technische Merkmale des Produkts	Acquastop

Oberfläche Gehäuse

Material	Stahl AISI 316L
Farbe	Stahl

Oberfläche Diffusor

Material	Extra-helles Glas - Gehärtet
Farbe	transparent
Bearbeitungstyp	Siebdruck

Oberfläche flansch

Material	Edelstahl 316
Farbe	Stahl
Bearbeitungstyp	Elektropolierbad

Elektronik

	83010 On/Off Driver 90~264V AC / 127~370V DC 60 W (1 art.)
---	---

	83015 DALI Controller 90~305V AC / 127~431V DC 120 W (1 - 3 art.)
---	--

	83013 On/Off Driver 180~305V AC / 254~431V DC 120 W (1 - 3 art.)
---	---

	83012 DALI Controller 90~305V AC / 127~431V DC 60 W (1 art.)
---	---

Unterwasserleuchten | 9 x powerLEDs 38 W DC 12 V | CRI 80 84042N31

Single emission submerged for outdoor application. The natural white LED light source with a mix flux 1 asymmetric + elliptic light distribution is composed of 9 powerled LEDs with CCT of 4000 K and a CRI 80; the source luminous flux is 4921 lm, with a 129.5 lm/W nominal luminous efficacy.

The device body is made of aisi 316l steel and features a steel finish; the diffuser is made of extra clear glass - tempered with a silk-screening treatment. The ingress protection degree is IP68; the total weight is of 0.8 kg. The power supply driver is not provided and is to be ordered separately.

The total absorbed power is 38 W. The power supply cable is included and features a 5 m length.

The device features protection class III and can be wall lights or floor-mounted with an outer casing, code 83198(for concrete or masonry).

Compliant with the EN 60598-1 standard and its specific provisions.

Energieeffizienzklasse

Dieses Produkt enthält 3 Lichtquellen der Energieeffizienzklasse E.

Illuminotechnical Eigenschaften

Light Output Ratio (LOR)	74 %
Lichtstrom (Lichtquelle)	4921 lm
Leuchten Lichtstrom	3651 lm
Consumption	38 W
Leuchten Lichtausbeute	96 lm/W
Farbtemperatur	4000 K
Standard Deviation of Colour Matching	3 Step MacAdam
Farbwiedergabeindex	80 Ra

Standardumgebungstemperatur	-20 / +50°C
Typische Temperatur am Glas	40°C

LED Life / Failure Ratio

L70 B10 C0 250000h (at Tj 65 Ta 25)

OPTICAL

Optik C0/C180	33°
Light distribution simmetry	Asymmetrical

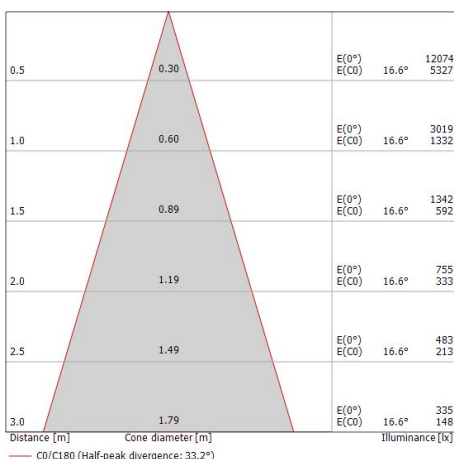
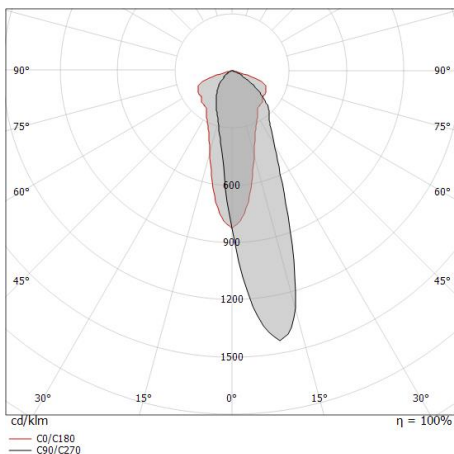

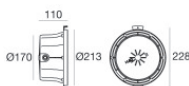

Einbaugehäuse - Gehäuse IP68 zur Montage auf Mauerwerk (Fliesen oder Mosaik)
installationsposition: wand; typ installation: mauerwerk L=213mm, H=213mm, D=110mm.
Material:Kunststoff ABS, farbe:Schwarz.

Code
83142

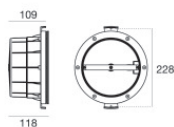
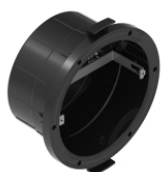

Einbaugehäuse - Außengehäuse zur Installation auf Leinwand
installationsposition: wand; typ installation: mauerwerk L=213mm, H=213mm, D=110mm.
Material:Kunststoff ABS, farbe:Schwarz.

Code
83198