

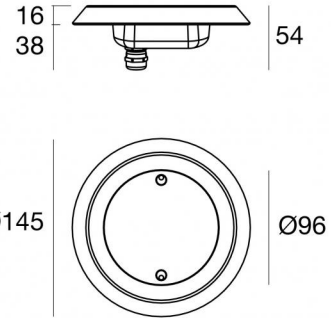

Unterwasserleuchten | 3 x powerLEDs 13 W DC 350 mA  
 RGBW - 4000  
**84036Q20**



Technische Daten	
Typ	Frame
Installationsposition	Wand - Boden
Installationsumgebung	Outdoor
Lichtquelle	LED
Circuit structure	powerLEDs
Optik	Flood
Light emission direction	frontal
Lampe Nennleistung	13 W DC
Eingangsspannungsbereich	350mA
Ähnlichste Farbtemperatur / Tone	RGBW - 4000 K
Gleichstrom/Gleichspannung	CC
Isolierklasse	3
IP	IP68
Maximale Einbautiefe	25 m
Installationsbeschränkung	Nur unter Wasser
IK	IK10
Glühdrahtprüfung	850°
Direkte Montage auf normal entflammaren Oberflächen	Ja
CE	Ja
Einschließlich Driver	Nein
Leuchte dimmbar	Ja
Schwenkbarkeit	Nein
Drehbarkeit	Nein
Begehbarkeit	Nein
Überrollbarkeit	Nein
Einschließlich Kabel	Ja
Kabellänge	5 m
Harzbeschichtung	Ja
Typ Lichtabstrahlung	Einflammig
Nettogewicht	1.9 Kg
Schutz vor elektrostatischen Entladungen	Nein
Schutz vor Stoßspannungen	Nein
Technische Merkmale des Produkts	Acquastop

### Oberfläche Gehäuse

Material	Stahl AISI 316L
Farbe	Stahl

### Oberfläche Diffusor

Material	Extra-helles Glas - Gehärtet
Farbe	transparent
Bearbeitungstyp	Siebdruck

### Oberfläche flansch

Material	Edelstahl 316
Farbe	Stahl
Bearbeitungstyp	Elektropolierbad

### Elektronik

	83010 On/Off Driver 90~264V AC / 127~370V DC 60 W (1 - 4 art.)
---	---

	83187 Push and Simply Dim - DMX-RDM Multi Channel 4ch. 10.8~52.8V DC (1 art.)
---	--

### Lumen RGBW

N. Led	Rot	Grün	Blau	Weiß
3	135 lm	312 lm	105 lm	402 lm



Unterwasserleuchten | 3 x powerLEDs 13 W DC 350 mA | RGBW - 4000  
**84036Q20**

Single emission submerged for outdoor application. The RGBW - 4000 K LED light source with a flood light distribution is composed of 3 powered LEDs with CCT of RGB-W 4000 K.

The device body is made of aisi 316l steel and features a steel finish; the diffuser is made of extra clear glass - tempered with a silk-screening treatment. The ingress protection degree is IP68; the total weight is of 1.9 kg. The power supply driver is not provided and is to be ordered separately.

The total absorbed power is 13 W. The power supply cable is included and features a 5 m length.

The device features protection class III and can be wall lights or floor-mounted with an outer casing, code 83197 (for concrete or masonry).

Compliant with the EN 60598-1 standard and its specific provisions.

Standardumgebungstemperatur	-20 / +50°C
Typische Temperatur am Glas	40°C



Nautilus\_R | Submerged | Accessories  
**84036Q20**

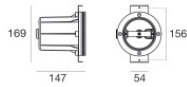

Einbaugehäuse - Außengehäuse zur Installation auf Leinwand  
 installationsposition: wand; typ installation: mauerwerk L=131mm, H=131mm, D=139mm.  
 Material:Kunststoff ABS, farbe:Schwarz.

**Code**  
83197

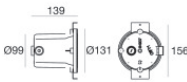

Einbaugehäuse - Gehäuse IP68 zur Montage auf Mauerwerk (Fliesen oder Mosaik)  
 installationsposition: wand; typ installation: mauerwerk L=131mm, H=131mm, D=139mm.  
 Material:Kunststoff ABS, farbe:Schwarz.

**Code**  
83141

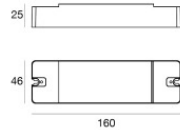

Dimmer  
 RF Remote controller

**Code**  
C-E700003

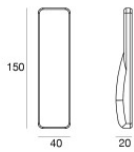

Remote RF

**Code**  
C-W600001