

# Tour\_Projectors

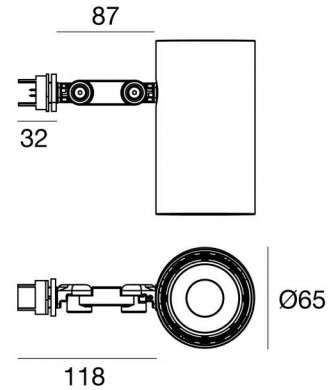

Scheinwerfer | 1 arrayLED 15 W DC 420 mA | CRI 90  
**82757M60**



Technische Daten	
Typ	Oberfläche
Installationsposition	Decke
Installationsumgebung	Indoor
Lichtquelle	LED
Circuit structure	arrayLED
Optik	Wide Flood
Light emission direction	frontal
Lampe Nennleistung	15 W DC
Lichtstrom (Lichtquelle)	2214 lm
Ähnlichste Farbtemperatur / Tone	2700 K
Farbwiedergabeindex	90 Ra
Gleichstrom/Gleichspannung	DC
Isolierklasse	2
IP	IP20
Glühdrahtprüfung	850°
Direkte Montage auf normal entflammaren Oberflächen	Ja
CE	Ja
Leuchte dimmbar	Nein
Schwenkbarkeit	Orientabile
Gesamtwinkel (vertikale Ebene)	180 °
Gesamtwinkel (horizontale Ebene)	360 °
Drehbarkeit	Nein
Begehbarkeit	Nein
Überrollbarkeit	Nein
Einschließlich Kabel	Nein
Harzbeschichtung	Nein
Typ Lichtabstrahlung	Einflammig
Nettogewicht	0.53 Kg
Schutz vor elektrostatischen Entladungen	Nein
Schutz vor Stoßspannungen	Nein

Oberfläche Gehäuse	
Material	Aluminium
Farbe	Weiß
Bearbeitungstyp	Lackierung

Scheinwerfer | 1 arrayLED 15 W DC 420 mA | CRI 90  
**82757M60**

Single emission projectors for indoor application. The super warm white LED light source with a wide flood light distribution is composed of 1 arrayed LEDs with CCT of 2700 K and a CRI 90; the source luminous flux is 2214 lm, with a 147.6 lm/W nominal luminous efficacy.

The device body is made of aluminium and features a white finish, processed by means of coating. The ingress protection degree is IP20; the total weight is of 0.53 kg.

The total absorbed power is 15 W.

The device features protection class II and can be ceiling-mounted.

Compliant with the EN 60598-1 standard and its specific provisions.

### Energieeffizienzklasse

ieses Produkt enthält eine Lichtquelle der Energieeffizienzklasse E.

### Illuminotechnical Eigenschaften

Light Output Ratio (LOR)	71 %
Lichtstrom (Lichtquelle)	2214 lm
Leuchten Lichtstrom	1588 lm
Consumption	15 W
Leuchten Lichtausbeute	105 lm/W
Farbtemperatur	2700 K
Standard Deviation of Colour Matching	2 Step MacAdam
Farbwiedergabeindex	90 Ra
Colour Rendering Index	60 R9
Black Body Locus	On
Standardumgebungstemperatur	-20 / +50°C

### LED Life / Failure Ratio

L70 B10 C0 252000h (at Tj 65 Ta 25 )

### UGR

UGR axial	22.1
UGR transversal	22.1
X=4H   Y=8H	S=0.25H
Reflection factor	70/50/20

### OPTICAL

Optik C0/C180	56°
Light distribution simmetry	Symmetrical

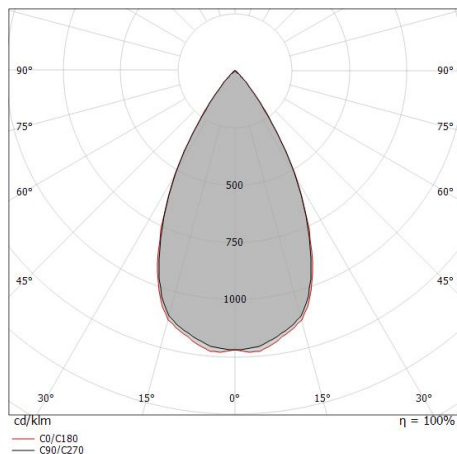

Distance [m]	Cone diameter [m]	E(0°)	E(C90)	E(C0)
0.5	0.53 0.53	7746	2675	2696
1.0	1.06 1.07	1936	669	674
1.5	1.60 1.60	861	297	300
2.0	2.13 2.14	484	167	168
2.5	2.66 2.67	310	107	108
3.0	3.19 3.20	215	74	75

Illuminance [lx]

— C0/C180 (Half-peak divergence: 56.2°)  
 — C90/C270 (Half-peak divergence: 56.0°)





Scheinwerfer | 1 arrayLED 15 W DC 420 mA | CRI 90  
**82757M60**

## Components

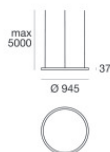







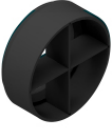

Tour\_Track

**Code**

82753 - 82754 - 82756 - 82755



	<p>Diffusor Diffusorart: filtro ellittico. Material:Pom-C, farbe:Schwarz.</p>	<p><b>Code</b> <u>99781</u></p>
	<p>Blendschutz Blendschutzart: wabenraster. Material:Pom-C, farbe:Schwarz.</p>	<p><b>Code</b> <u>99780</u></p>
	<p>Blendschutz Blendschutzart: frangiluce a croce. Material:Pom-C, farbe:Schwarz.</p>	<p><b>Code</b> <u>99779</u></p>
	<p>Blendschutz Blendschutzart: schermo cilindrico. Material:Pom-C, farbe:Schwarz.</p>	<p><b>Code</b> <u>99783</u></p>
	<p>Blendschutz Blendschutzart: schermo cilindrico 45°. Material:Pom-C, farbe:Schwarz.</p>	<p><b>Code</b> <u>99782</u></p>
	<p>Optik Lichtverteilung: spot,Material Verkleidung: polycarbonat uv-beständige</p>	<p><b>Code</b> <u>99827</u></p>
	<p>Optik Lichtverteilung: medium flood,Material Verkleidung: ,polycarbonat uv- beständige,polycarbonat uv-beständige,polycarbonat uv-beständige</p>	<p><b>Code</b> <u>99828</u></p>
	<p>Optik Lichtverteilung: flood,Material Verkleidung: ,polycarbonat uv-beständige,polycarbonat uv- beständige,polycarbonat uv-beständige</p>	<p><b>Code</b> <u>99829</u></p>