

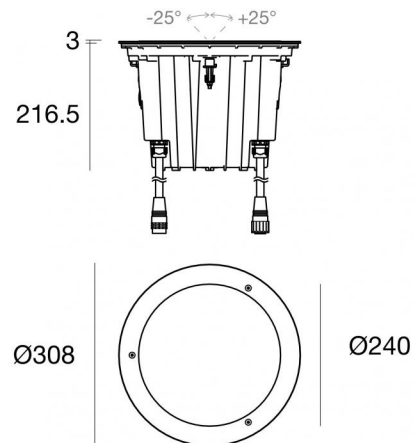

Uplights | 198-264 V AC /180-275 V DC
24 x powerLEDs 37 W DC - 41 W AC | RGBW - 3000
82724V50



Technische Daten	
Typ	Überrollbar
Installationsposition	Boden
Installationsumgebung	Outdoor
Lichtquelle	LED
Circuit structure	powerLEDs
Optik	Wide Flood
Light emission direction	upward
Lampe Nennleistung	37 W DC
Gesamtleistung	41 W
Nominale Eingangsspannung	220 - 240 V AC
Eingangsspannungsbereich	198 - 264 V AC
Frequency	50 - 60 Hz
Ähnlichste Farbtemperatur / Tone	RGBW - 3000 K
Gleichstrom/Gleichspannung	AC
Isolierklasse	1
IP	IP68
Installationsbeschränkung	Nicht für Einsatz unter Wasser
IK	IK10
Glühdrahtprüfung	850°
Direkte Montage auf normal entflammaren Oberflächen	Nein
CE	Ja
Einschließlich Driver	Control unit/Driver
Leuchte dimmbar	DMX-RDM
Schwenkbarkeit	Nein
Drehbarkeit	Ja
Gesamtwinkel (vertikale Ebene)	50 °
Begehbarkeit	Ja
Überrollbarkeit	5000 Kg
Einschließlich Kabel	Ja
Kabellänge	0.2 m
Harzbeschichtung	Ja
Typ Lichtabstrahlung	Einflammig
Nettogewicht	8 Kg
Schutz vor elektrostatischen Entladungen	Ja
Schutz vor Stoßspannungen	Ja
Technische Merkmale des Produkts	Acquastop

Oberfläche Gehäuse

Material	Stranggepresstes Aluminium EN AB - 46100
Farbe	Schwarz
Bearbeitungstyp	Offenporige Anodisierung + Pulverlackierung

Oberfläche Diffusor

Material	Extra-helles Glas - Gehärtet
Farbe	transparent
Bearbeitungstyp	Siebdruck

Oberfläche flansch

Material	Stahl AISI 316
Farbe	Stahl
Bearbeitungstyp	Bürsten

Cables Electrification+signal

IP (locked condition)	67
Cable connector	ALLinONE Female Socket 6 Pin
Cable connector	AllinONE Male Plug 6 Pin

Lumen RGBW

N. Led	Rot	Grün	Blau	Weiß
24	438 lm	894 lm	318 lm	1206 lm

Das im Gerät enthaltene Netzteil entspricht IEC 61347-2-13 Anhang J und kann daher über zentrale Stromversorgungssysteme mit Strom versorgt werden.



Uplights | 198-264 V AC /180-275 V DC | 24 x powerLEDs 37 W DC - 41 W AC | RGBW - 3000
82724V50

Single emission uplights for outdoor application. The RGBW - 3000 K LED light source with a wide flood light distribution is composed of 24 powered LEDs with CCT of RGB-W 3000 K.

The device body is made of die-cast aluminium en ab - 46100 and features a black finish, processed by means of open pore anodizing + powder coating; the diffuser is made of extra clear glass - tempered with a silk-screening treatment. The ingress protection degree is IP68; the total weight is of 8 kg.

The total absorbed power is 37 W. The power supply cable is included and features a 0.2 m length.

The device features protection class I and can be floor-mounted with an outer casing, code 83096(for concrete or masonry).

Compliant with the EN 60598-1 standard and its specific provisions.

Energieeffizienzklasse

ieses Produkt enthält eine Lichtquelle der Energieeffizienzklasse E.











Illuminotechnical Eigenschaften

Standard Deviation of Colour Matching	3 Step MacAdam
Farbwiedergabeindex	90 Ra
Standardumgebungstemperatur	-20 / +50°C
Typische Temperatur am Glas	65°C

LED Life / Failure Ratio

L70 B10 C0 60500h

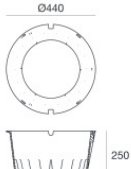

<p>L. 1m</p> 	<p>Kabel und Stecker Typ Kabel power + signal cable allinone; Länge 1000 mm; isolierung doppio con schermatura per segnale; außendurchmesser: 12.6 mm; farben: weiß - blau - rot - grau - braun - gelb-grün.</p>	<p>Code <u>98660</u></p>
<p>L. 5m</p> 	<p>Kabel und Stecker Typ Kabel power + signal cable allinone; Länge 5000 mm; isolierung doppio con schermatura per segnale; außendurchmesser: 12.6 mm; farben: weiß - blau - rot - grau - braun - gelb-grün.</p>	<p>Code <u>98661</u></p>
<p>L. 1m</p> 	<p>Kabel und Stecker Typ Kabel power + signal cable allinone; Länge 1000 mm; isolierung doppio con schermatura per segnale; außendurchmesser: 12.6 mm.</p>	<p>Code <u>98662</u></p>
<p>L. 5m</p> 	<p>Kabel und Stecker Typ Kabel power + signal cable allinone; Länge 5000 mm; isolierung doppio con schermatura per segnale; außendurchmesser: 12.6 mm.</p>	<p>Code <u>98663</u></p>
 	<p>Stecker - Start splitter Typ Kabel power + signal cable allinone; Länge 5000 + 5000 + 200 mm; isolierung doppio con schermatura per segnale.</p>	<p>Code <u>98985</u></p>
 	<p>Stecker - Continuity splitter Typ Kabel power + signal cable allinone; Länge 200 + 200 + 5000 mm; isolierung doppio con schermatura per segnale.</p>	<p>Code <u>99390</u></p>
	<p>Stecker - DMX-Leitungsverschlussadapter für ALLinONE-Kabel Typ Kabel power + signal cable allinone; ; isolierung doppio con schermatura per segnale.</p>	<p>Code <u>98986</u></p>
 	<p>Einbaugehäuse installationsposition: boden; typ installation: mauerwerk L=440mm, H=250mm, D=440mm. Material:Kunststoff ABS, farbe:Schwarz.</p>	<p>Code <u>83096</u></p>



Suelo_RXFJ | Uplights | Accessories
82724V50

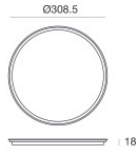

Lochschablone

Code
83098

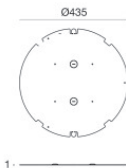

Zubehör für Außengehäuse - Gehäuseboden für Außengehäuse
Material:Verzinktes Eisen, farbe:Grau, bearbeitungstyp :Verzinken.

Code
93099