

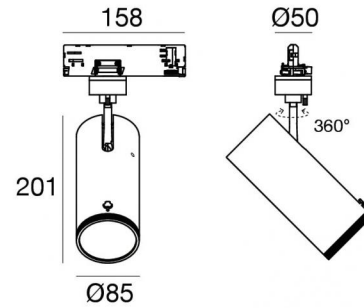

Scheinwerfer | 198-264 V  
1 arrayLED 32.5 W DC - 37 W AC | CRI 98  
**82449W85**



Technische Daten	
Typ	Schiene
Installationsposition	Decke
Installationsumgebung	Indoor
Lichtquelle	LED
Circuit structure	arrayLED
Optik	Adjustable Focus
Light emission direction	frontal
Lampe Nennleistung	32.5 W DC
Gesamtleistung	37 W
Lichtstrom (Lichtquelle)	3450 lm
Nominale Eingangsspannung	220 - 240 V AC
Eingangsspannungsbereich	198 - 264 V AC
Frequency	50 - 60 Hz
Ähnlichste Farbtemperatur / Tone	3000 K
Farbwiedergabeindex	98 Ra
Gleichstrom/Gleichspannung	AC
Isolierklasse	2
IP	IP20
Glühdrahtprüfung	850°
Direkte Montage auf normal entflammaren Oberflächen	Ja
CE	Ja
Einschließlich Driver	Driver
Leuchte dimmbar	Dimming on Board
Schwenkbarkeit	Orientabile
Gesamtwinkel (vertikale Ebene)	90 °
Gesamtwinkel (horizontale Ebene)	360 °
Drehbarkeit	Nein
Begehbarkeit	Nein
Überrollbarkeit	Nein
Einschließlich Kabel	Nein
Harzbeschichtung	Nein
Typ Lichtabstrahlung	Einflammig
Nettogewicht	0.92 Kg
Schutz vor elektrostatischen Entladungen	Ja
Schutz vor Stoßspannungen	2 KV

Oberfläche Gehäuse	
Material	Stranggepresstes Aluminium EN AB - 46100
Farbe	Schwarz
Bearbeitungstyp	Pulverbeschichtung



Scheinwerfer | 198-264 V | 1 arrayLED 32.5 W DC - 37 W AC | CRI 98 | Maximaler optischer Winkel  
**82449W85**

Single emission projectors for indoor application. The warm white LED light source with a adjustable focus light distribution is composed of 1 arrayed LEDs with CCT of 3000 K and a CRI 98; the source luminous flux is 3450 lm, with a 106.2 lm/W nominal luminous efficacy.

The device body is made of die-cast aluminium en ab - 46100 and features a black finish, processed by means of powder coating. The ingress protection degree is IP20; the total weight is of 0.92 kg.

The total absorbed power is 37 W.

The device features protection class II and can be ceiling-mounted.

Compliant with the EN 60598-1 standard and its specific provisions.

### Energieeffizienzklasse

ieses Produkt enthält eine Lichtquelle der Energieeffizienzklasse F.

### Illuminotechnical Eigenschaften

Light Output Ratio (LOR)	58 %
Lichtstrom (Lichtquelle)	3450 lm
Leuchten Lichtstrom	2031 lm
Consumption	37 W
Leuchten Lichtausbeute	54 lm/W
Farbtemperatur	3000 K
Standard Deviation of Colour Matching	2 Step MacAdam
Farbwiedergabeindex	98 Ra
Black Body Locus	On
Standardumgebungstemperatur	-20 / +50°C
Typische Temperatur am Glas	40°C

### LED Life / Failure Ratio

L70 B10 C0 252000h (at Tj 65 Ta 25 )

### UGR

UGR axial	20.4
UGR transversal	20.3
X=4H   Y=8H	S=0.25H
Reflection factor	70/50/20

### OPTICAL

Optik C0/C180	59°
Light distribution simmetry	Symmetrical

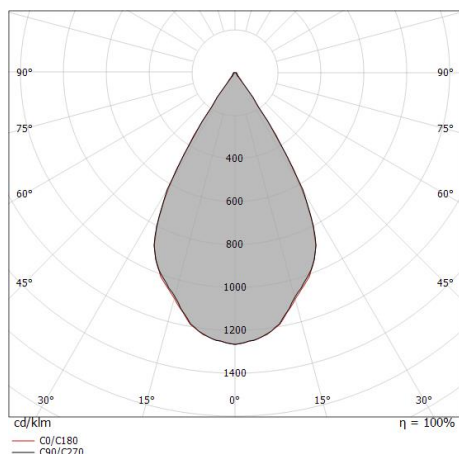

Distance [m]	Cone diameter [m]	illuminance [lx]
0.5	0.58 0.57	E(0°) 10274 E(C90) 29.9° 3359 E(C0) 29.7° 3389
1.0	1.15 1.14	E(0°) 2568 E(C90) 29.9° 840 E(C0) 29.7° 847
1.5	1.73 1.71	E(0°) 1142 E(C90) 29.9° 373 E(C0) 29.7° 377
2.0	2.30 2.28	E(0°) 642 E(C90) 29.9° 210 E(C0) 29.7° 212
2.5	2.88 2.85	E(0°) 411 E(C90) 29.9° 134 E(C0) 29.7° 136
3.0	3.45 3.42	E(0°) 285 E(C90) 29.9° 93 E(C0) 29.7° 94

— C0/C180 (Half-peak divergence: 59.4°)  
 — C90/C270 (Half-peak divergence: 59.8°)

### COLOR VECTOR GRAPHIC





Scheinwerfer | 198-264 V | 1 arrayLED 32.5 W DC - 37 W AC | CRI 98 | Minimaler optischer

Winkel

**82449W85**

Single emission projectors for indoor application. The warm white LED light source with a adjustable focus light distribution is composed of 1 arrayed LEDs with CCT of 3000 K and a CRI 98; the source luminous flux is 3450 lm, with a 106.2 lm/W nominal luminous efficacy.

The device body is made of die-cast aluminium en ab - 46100 and features a black finish, processed by means of powder coating. The ingress protection degree is IP20; the total weight is of 0.92 kg.

The total absorbed power is 37 W.

The device features protection class II and can be ceiling-mounted.

Compliant with the EN 60598-1 standard and its specific provisions.

### Energieeffizienzklasse

ieses Produkt enthält eine Lichtquelle der Energieeffizienzklasse F.

### Illuminotechnical Eigenschaften

Light Output Ratio (LOR)	28 %
Lichtstrom (Lichtquelle)	3450 lm
Leuchten Lichtstrom	974 lm
Consumption	37 W
Leuchten Lichtausbeute	26 lm/W
Farbtemperatur	3000 K
Standard Deviation of Colour Matching	2 Step MacAdam
Farbwiedergabeindex	98 Ra
Black Body Locus	On
Standardumgebungstemperatur	-20 / +50°C
Typische Temperatur am Glas	40°C

### LED Life / Failure Ratio

L70 B10 C0 252000h (at Tj 65 Ta 25 )

### UGR

UGR axial	11
UGR transversal	11.1
X=4H   Y=8H	S=0.25H
Reflection factor	70/50/20

### OPTICAL

Optik C0/C180	16°
Light distribution simmetry	Symmetrical

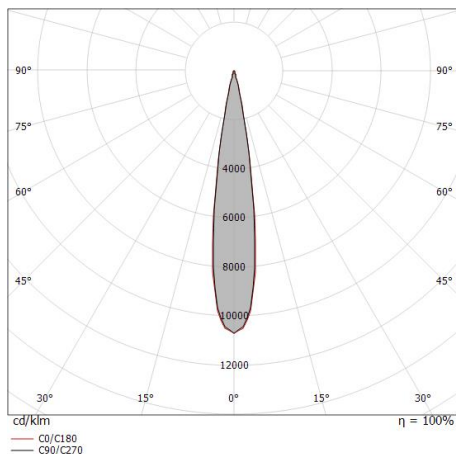

Distance [m]	Cone diameter [m]	illuminance [lx]
0.5	0.15 0.15	E(0°) 41693 E(C90) 8.2° 20647 E(C0) 8.5° 20229
1.0	0.29 0.30	E(0°) 10423 E(C90) 8.2° 5162 E(C0) 8.5° 5057
1.5	0.43 0.45	E(0°) 4633 E(C90) 8.2° 2294 E(C0) 8.5° 2248
2.0	0.58 0.60	E(0°) 2606 E(C90) 8.2° 1290 E(C0) 8.5° 1264
2.5	0.72 0.75	E(0°) 1668 E(C90) 8.2° 826 E(C0) 8.5° 809
3.0	0.86 0.90	E(0°) 1158 E(C90) 8.2° 574 E(C0) 8.5° 562

— C0/C180 (Half-peak divergence: 17.0°)  
— C90/C270 (Half-peak divergence: 16.4°)

### COLOR VECTOR GRAPHIC





		<p>Stromversorgung Material:PC, farbe:Weiß.</p>	<p><b>Code</b> <u>81033</u></p>
		<p>Stromversorgung Material:PC, farbe:Weiß.</p>	<p><b>Code</b> <u>81036</u></p>
		<p>Stromversorgung Material:PC, farbe:Schwarz.</p>	<p><b>Code</b> <u>81037</u></p>
		<p>Stromversorgung Material:PC, farbe:Schwarz.</p>	<p><b>Code</b> <u>81034</u></p>
		<p>Endkappe Material:PC, farbe:Weiß.</p>	<p><b>Code</b> <u>80999</u></p>
		<p>Endkappe Material:PC, farbe:Schwarz.</p>	<p><b>Code</b> <u>81000</u></p>
		<p>Endkappe Material:PC, farbe:Weiß.</p>	<p><b>Code</b> <u>81002</u></p>
		<p>Endkappe Material:PC, farbe:Schwarz.</p>	<p><b>Code</b> <u>81003</u></p>



Endkappe  
Material:Weiß.

**Code**  
81084



Endkappe  
Material:Schwarz, farbe:Schwarz.

**Code**  
81085



Deckenrosette  
Material:Kunststoff, farbe:Weiß.

**Code**  
81012



Deckenrosette  
Material:Kunststoff, farbe:Schwarz.

**Code**  
81014



Deckenrosette  
Material:Kunststoff, farbe:Weiß.

**Code**  
81013



Deckenrosette  
Material:Kunststoff, farbe:Schwarz.

**Code**  
81015



Klammer  
L=35mm, H=14mm, D=24mm.  
Material:Aluminium, farbe:poliert.

**Finish**  
Anod. Al. **Code**  
81086



Klammer  
L=180mm, H=24mm, D=26mm.  
Material:Aluminium, farbe:Eloxiertes Aluminium, bearbeitungstyp :Eloxierung.

**Finish**  
**Code**  
81024



Klammer

L=180mm, H=24mm, D=20mm.

Material:Aluminium, farbe:Weiß RAL 9010, bearbeitungstyp :Lackierung.

**Finish**

White

**Code**

81025



Klammer

L=180mm, H=24mm, D=20mm.

Material:Aluminium, farbe:Schwarz RAL 9005, bearbeitungstyp :Lackierung.

**Finish**

Black

**Code**

81026



Klammer

L=35mm, H=14mm, D=24mm.

Material:Aluminium, farbe:Weiß, bearbeitungstyp :Lackierung.

**Finish**

White

**Code**

81087



Klammer

L=35mm, H=14mm, D=24mm.

Material:Aluminium, farbe:Schwarz, bearbeitungstyp :Lackierung.

**Finish**

Black

**Code**

81088

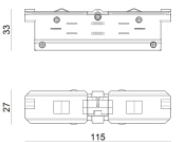

Kabelverbindung

Typ linear.

Material:PC, farbe:Weiß.

**Finish**

White

**Code**

81039

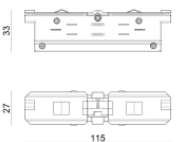

Kabelverbindung

Typ linear.

Material:PC, farbe:Schwarz.

**Finish**

Black

**Code**

81040



Kabelverbindung

Typ linear.

Material:PC, farbe:Weiß.

**Finish**

White

**Code**

81042

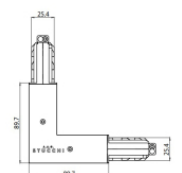

Kabelverbindung

Typ linear.

Material:PC, farbe:Weiß.

**Finish**

White

**Code**

81045



		<p>Kabelverbindung Typ linear. Material:PC, farbe:Weiß.</p>	<p><b>Finish</b> White</p>	<p><b>Code</b> 81048</p>
		<p>Kabelverbindung Typ flexible curve. Material:PC, farbe:Weiß.</p>	<p><b>Finish</b> White</p>	<p><b>Code</b> 81066</p>
		<p>Kabelverbindung Typ linear. Material:PC, farbe:Weiß.</p>	<p><b>Finish</b> White</p>	<p><b>Code</b> 81063</p>
		<p>Kabelverbindung Typ linear. Material:PC, farbe:Weiß.</p>	<p><b>Finish</b> White</p>	<p><b>Code</b> 81051</p>
		<p>Kabelverbindung Typ linear. Material:PC, farbe:Weiß.</p>	<p><b>Finish</b> White</p>	<p><b>Code</b> 81054</p>
		<p>Kabelverbindung Typ linear. Material:PC, farbe:Weiß.</p>	<p><b>Finish</b> White</p>	<p><b>Code</b> 81057</p>
		<p>Kabelverbindung Typ linear. Material:PC, farbe:Weiß.</p>	<p><b>Finish</b> White</p>	<p><b>Code</b> 81060</p>
		<p>Kabelverbindung Typ linear. Material:PC, farbe:Schwarz.</p>	<p><b>Finish</b> Black</p>	<p><b>Code</b> 81043</p>



		<p>Kabelverbindung Typ linear. Material:PC, farbe:Schwarz.</p>	<p><b>Finish</b> Black</p>	<p><b>Code</b> 81046</p>
		<p>Kabelverbindung Typ linear. Material:PC, farbe:Schwarz.</p>	<p><b>Finish</b> Black</p>	<p><b>Code</b> 81049</p>
		<p>Kabelverbindung Typ flexible curve. Material:PC, farbe:Schwarz.</p>	<p><b>Finish</b> Black</p>	<p><b>Code</b> 81067</p>
		<p>Kabelverbindung Typ linear. Material:PC, farbe:Schwarz.</p>	<p><b>Finish</b> Black</p>	<p><b>Code</b> 81064</p>
		<p>Kabelverbindung Typ linear. Material:PC, farbe:Schwarz.</p>	<p><b>Finish</b> Black</p>	<p><b>Code</b> 81052</p>
		<p>Kabelverbindung Typ linear. Material:PC, farbe:Schwarz.</p>	<p><b>Finish</b> Black</p>	<p><b>Code</b> 81055</p>
		<p>Kabelverbindung Typ linear. Material:PC, farbe:Schwarz.</p>	<p><b>Finish</b> Black</p>	<p><b>Code</b> 81058</p>
		<p>Kabelverbindung Typ linear. Material:PC, farbe:Schwarz.</p>	<p><b>Finish</b> Black</p>	<p><b>Code</b> 81061</p>





	<p>Hängeleuchten Material:Kunststoff, farbe:Weiß.</p>	<p><b>Code</b> <u>81006</u></p>
	<p>Hängeleuchten Material:Kunststoff, farbe:Weiß.</p>	<p><b>Code</b> <u>81007</u></p>
	<p>Hängeleuchten Material:Kunststoff, farbe:Schwarz.</p>	<p><b>Code</b> <u>81008</u></p>
	<p>Hängeleuchten Material:Kunststoff, farbe:Schwarz.</p>	<p><b>Code</b> <u>81009</u></p>
	<p>Hängeleuchten Material:Kunststoff, farbe:Weiß.</p>	<p><b>Code</b> <u>81018</u></p>
	<p>Hängeleuchten Material:Kunststoff, farbe:Schwarz.</p>	<p><b>Code</b> <u>81019</u></p>
	<p>Hängeleuchten Material:Kunststoff, farbe:Weiß.</p>	<p><b>Code</b> <u>81021</u></p>
	<p>Hängeleuchten Material:Kunststoff, farbe:Schwarz.</p>	<p><b>Code</b> <u>81022</u></p>



		<p>Drahtabdeckung Material:PC, farbe:Weiß.</p>	<p><b>Code</b> <u>81069</u></p>
		<p>Drahtabdeckung Material:PC, farbe:Weiß.</p>	<p><b>Code</b> <u>81072</u></p>
		<p>Drahtabdeckung Material:PC, farbe:Weiß.</p>	<p><b>Code</b> <u>81075</u></p>
		<p>Drahtabdeckung Material:PC, farbe:Weiß.</p>	<p><b>Code</b> <u>81078</u></p>
		<p>Drahtabdeckung Material:PC, farbe:Weiß.</p>	<p><b>Code</b> <u>81081</u></p>
		<p>Drahtabdeckung Material:PC, farbe:Schwarz.</p>	<p><b>Code</b> <u>81070</u></p>
		<p>Drahtabdeckung Material:PC, farbe:Schwarz.</p>	<p><b>Code</b> <u>81073</u></p>
		<p>Drahtabdeckung Material:PC, farbe:Schwarz.</p>	<p><b>Code</b> <u>81076</u></p>



		<p>Drahtabdeckung Material:PC, farbe:Schwarz.</p>	<p><b>Code</b> <u>81079</u></p>
		<p>Drahtabdeckung Material:PC, farbe:Schwarz.</p>	<p><b>Code</b> <u>81082</u></p>
		<p>Drahtabdeckung Material:Weiß.</p>	<p><b>Code</b> <u>83249</u></p>
		<p>Drahtabdeckung Material:Schwarz, farbe:Schwarz.</p>	<p><b>Code</b> <u>83250</u></p>
			<p><b>Code</b> <u>81094</u></p>
			<p><b>Code</b> <u>81091</u></p>
			<p><b>Code</b> <u>81095</u></p>
			<p><b>Code</b> <u>81093</u></p>



	Werkzeug	Code		
		81005		
		Schiene	Finish	Code
		Länge: 1000mm; Typ Schiene: Standard.	White	80990
		Material:Aluminium, farbe:Weiß, bearbeitungstyp :Lackierung.		
		Schiene	Finish	Code
		Länge: 2000mm; Typ Schiene: Standard.	White	80991
		Material:Aluminium, farbe:Weiß, bearbeitungstyp :Lackierung.		
		Schiene	Finish	Code
		Länge: 3000mm; Typ Schiene: Standard.	White	80992
		Material:Aluminium, farbe:Weiß, bearbeitungstyp :Lackierung.		
		Schiene	Finish	Code
		Länge: 1000mm; Typ Schiene: Standard.	Black	80993
		Material:Aluminium, farbe:Schwarz, bearbeitungstyp :Lackierung.		
		Schiene	Finish	Code
		Länge: 2000mm; Typ Schiene: Standard.	Black	80994
		Material:Aluminium, farbe:Schwarz, bearbeitungstyp :Lackierung.		
		Schiene	Finish	Code
		Länge: 3000mm; Typ Schiene: Standard.	Black	80995
		Material:Aluminium, farbe:Schwarz, bearbeitungstyp :Lackierung.		
		Schiene	Finish	Code
		Länge: 1000mm; Typ Schiene: Standard.	White	83336
		Material:Aluminium, farbe:Weiß, bearbeitungstyp :Lackierung.		

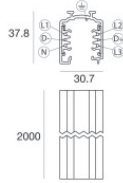

Schiene

Länge: 2000mm; Typ Schiene: Standard.

Material:Aluminium, farbe:Weiß, bearbeitungstyp :Lackierung.

**Finish**

White

**Code**

83337

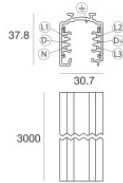

Schiene

Länge: 3000mm; Typ Schiene: Standard.

Material:Aluminium, farbe:Weiß, bearbeitungstyp :Lackierung.

**Finish**

White

**Code**

83338

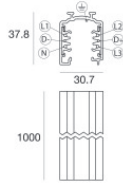

Schiene

Länge: 1000mm; Typ Schiene: Standard.

Material:Aluminium, farbe:Schwarz, bearbeitungstyp :Lackierung.

**Finish**

Black

**Code**

83339

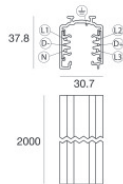

Schiene

Länge: 2000mm; Typ Schiene: Standard.

Material:Aluminium, farbe:Schwarz, bearbeitungstyp :Lackierung.

**Finish**

Black

**Code**

83340

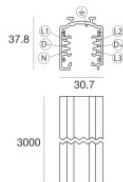

Schiene

Länge: 3000mm; Typ Schiene: Standard.

Material:Aluminium, farbe:Schwarz, bearbeitungstyp :Lackierung.

**Finish**

Black

**Code**

83341