

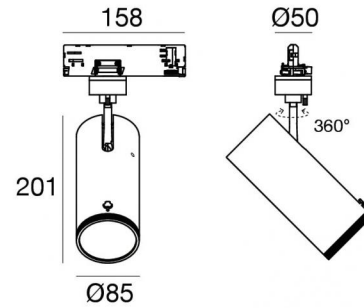

Scheinwerfer | 198-264 V
1 arrayLED 32.5 W DC - 37 W AC | CRI 92
82110W85



Technische Daten	
Typ	Schiene
Installationsposition	Decke
Installationsumgebung	Indoor
Lichtquelle	LED
Circuit structure	arrayLED
Optik	Adjustable Focus
Light emission direction	frontal
Lampe Nennleistung	32.5 W DC
Gesamtleistung	37 W
Lichtstrom (Lichtquelle)	3937 lm
Nominale Eingangsspannung	220 - 240 V AC
Eingangsspannungsbereich	198 - 264 V AC
Frequency	50 - 60 Hz
Ähnlichste Farbtemperatur / Tone	3000 K
Farbwiedergabeindex	92 Ra
Gleichstrom/Gleichspannung	AC
Isolierklasse	2
IP	IP20
Glühdrahtprüfung	850°
Direkte Montage auf normal entflammaren Oberflächen	Ja
CE	Ja
Einschließlich Driver	Driver
Leuchte dimmbar	Dimming on Board
Schwenkbarkeit	Orientabile
Gesamtwinkel (vertikale Ebene)	90 °
Gesamtwinkel (horizontale Ebene)	360 °
Drehbarkeit	Nein
Begehbarkeit	Nein
Überrollbarkeit	Nein
Einschließlich Kabel	Nein
Harzbeschichtung	Nein
Typ Lichtabstrahlung	Einflammig
Nettogewicht	0.92 Kg
Schutz vor elektrostatischen Entladungen	Ja
Schutz vor Stoßspannungen	2 KV

Oberfläche Gehäuse	
Material	Stranggepresstes Aluminium EN AB - 46100
Farbe	Schwarz
Bearbeitungstyp	Pulverbeschichtung

Scheinwerfer | 198-264 V | 1 arrayLED 32.5 W DC - 37 W AC | CRI 92 | Maximaler optischer Winkel
82110W85

Single emission projectors for indoor application. The warm white LED light source with a adjustable focus light distribution is composed of 1 arrayed LEDs with CCT of 3000 K and a CRI 92; the source luminous flux is 3937 lm, with a 121.1 lm/W nominal luminous efficacy.

The device body is made of die-cast aluminium en ab - 46100 and features a black finish, processed by means of powder coating. The ingress protection degree is IP20; the total weight is of 0.92 kg.

The total absorbed power is 37 W.

The device features protection class II and can be ceiling-mounted.

Compliant with the EN 60598-1 standard and its specific provisions.

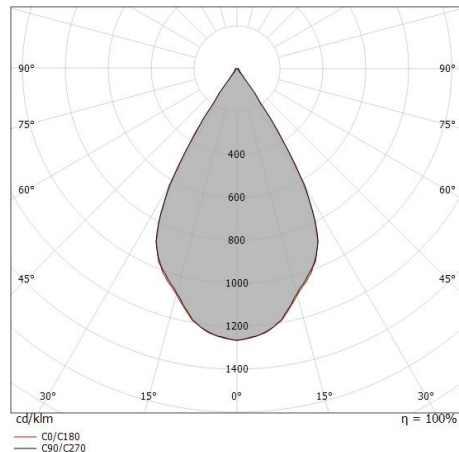

Distance [m]	Cone diameter [m]	illuminance [lx]
0.5	0.58 0.57	E(0°) 11724 E(C90) 29.9° 3833 E(C0) 29.7° 3867
1.0	1.15 1.14	E(0°) 2931 E(C90) 29.9° 958 E(C0) 29.7° 967
1.5	1.73 1.71	E(0°) 1303 E(C90) 29.9° 426 E(C0) 29.7° 430
2.0	2.30 2.28	E(0°) 733 E(C90) 29.9° 240 E(C0) 29.7° 242
2.5	2.88 2.85	E(0°) 469 E(C90) 29.9° 153 E(C0) 29.7° 155
3.0	3.45 3.42	E(0°) 326 E(C90) 29.9° 106 E(C0) 29.7° 107

— C0/C180 (Half-peak divergence: 59.4°)
 — C90/C270 (Half-peak divergence: 59.8°)

Energieeffizienzklasse

ieses Produkt enthält eine Lichtquelle der Energieeffizienzklasse F.

Illuminotechnical Eigenschaften

Light Output Ratio (LOR)	58 %
Lichtstrom (Lichtquelle)	3937 lm
Leuchten Lichtstrom	2317 lm
Consumption	37 W
Leuchten Lichtausbeute	62 lm/W
Farbtemperatur	3000 K
Standard Deviation of Colour Matching	2 Step MacAdam
Farbwiedergabeindex	92 Ra
Black Body Locus	On
Standardumgebungstemperatur	-20 / +50°C
Typische Temperatur am Glas	40°C

LED Life / Failure Ratio

L70 B10 C0 252000h (at Tj 65 Ta 25)

UGR

UGR axial	20.9
UGR transversal	20.8
X=4H Y=8H	S=0.25H
Reflection factor	70/50/20

OPTICAL

Optik C0/C180	59°
Light distribution simmetry	Symmetrical



Scheinwerfer | 198-264 V | 1 arrayLED 32.5 W DC - 37 W AC | CRI 92 | Minimaler optischer

Winkel

82110W85

Single emission projectors for indoor application. The warm white LED light source with a adjustable focus light distribution is composed of 1 arrayed LEDs with CCT of 3000 K and a CRI 92; the source luminous flux is 3937 lm, with a 121.1 lm/W nominal luminous efficacy.

The device body is made of die-cast aluminium en ab - 46100 and features a black finish, processed by means of powder coating. The ingress protection degree is IP20; the total weight is of 0.92 kg.

The total absorbed power is 37 W.

The device features protection class II and can be ceiling-mounted.

Compliant with the EN 60598-1 standard and its specific provisions.

Energieeffizienzklasse

ieses Produkt enthält eine Lichtquelle der Energieeffizienzklasse F.

Illuminotechnical Eigenschaften

Light Output Ratio (LOR)	28 %
Lichtstrom (Lichtquelle)	3937 lm
Leuchten Lichtstrom	1112 lm
Consumption	37 W
Leuchten Lichtausbeute	30 lm/W
Farbtemperatur	3000 K
Standard Deviation of Colour Matching	2 Step MacAdam
Farbwiedergabeindex	92 Ra
Black Body Locus	On
Standardumgebungstemperatur	-20 / +50°C
Typische Temperatur am Glas	40°C

LED Life / Failure Ratio

L70 B10 C0 252000h (at Tj 65 Ta 25)

UGR

UGR axial	11.5
UGR transversal	11.6
X=4H Y=8H	S=0.25H
Reflection factor	70/50/20

OPTICAL

Optik C0/C180	16°
Light distribution simmetry	Symmetrical

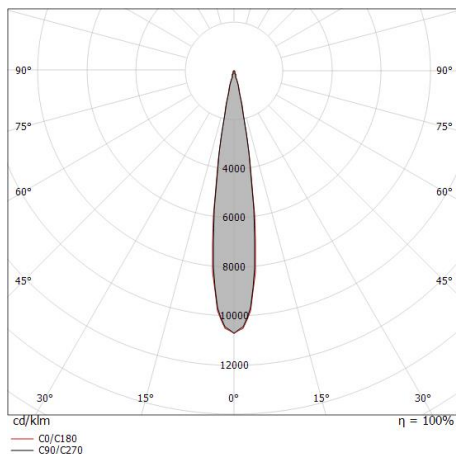

Distance [m]	Cone diameter [m]	illuminance [lx]
0.5	0.15 0.15	E(0°) 47602 E(C90) 8.2° 23573 E(C0) 8.5° 23096
1.0	0.29 0.30	E(0°) 11900 E(C90) 8.2° 5893 E(C0) 8.5° 5774
1.5	0.43 0.45	E(0°) 5289 E(C90) 8.2° 2819 E(C0) 8.5° 2566
2.0	0.58 0.60	E(0°) 2975 E(C90) 8.2° 1473 E(C0) 8.5° 1443
2.5	0.72 0.75	E(0°) 1904 E(C90) 8.2° 943 E(C0) 8.5° 924
3.0	0.86 0.90	E(0°) 1322 E(C90) 8.2° 655 E(C0) 8.5° 642

— C0/C180 (Half-peak divergence: 17.0°)
— C90/C270 (Half-peak divergence: 16.4°)

COLOR VECTOR GRAPHIC

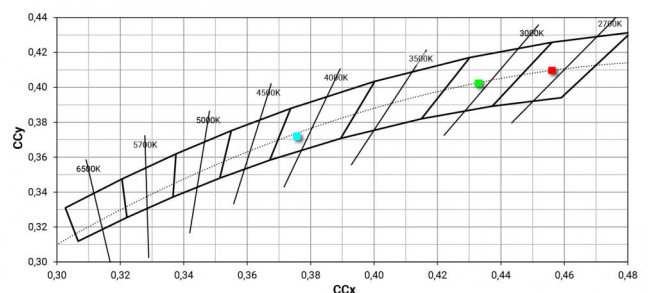
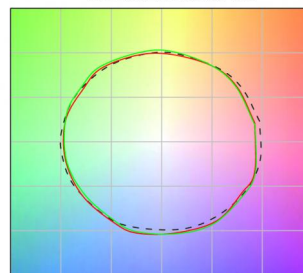



		<p>Stromversorgung Material:PC, farbe:Weiß.</p>	<p>Code <u>81033</u></p>
		<p>Stromversorgung Material:PC, farbe:Weiß.</p>	<p>Code <u>81036</u></p>
		<p>Stromversorgung Material:PC, farbe:Schwarz.</p>	<p>Code <u>81037</u></p>
		<p>Stromversorgung Material:PC, farbe:Schwarz.</p>	<p>Code <u>81034</u></p>
		<p>Endkappe Material:PC, farbe:Weiß.</p>	<p>Code <u>80999</u></p>
		<p>Endkappe Material:PC, farbe:Schwarz.</p>	<p>Code <u>81000</u></p>
		<p>Endkappe Material:PC, farbe:Weiß.</p>	<p>Code <u>81002</u></p>
		<p>Endkappe Material:PC, farbe:Schwarz.</p>	<p>Code <u>81003</u></p>



Endkappe
Material:Weiß.

Code
81084



Endkappe
Material:Schwarz, farbe:Schwarz.

Code
81085



Deckenrosette
Material:Kunststoff, farbe:Weiß.

Code
81012



Deckenrosette
Material:Kunststoff, farbe:Schwarz.

Code
81014



Deckenrosette
Material:Kunststoff, farbe:Weiß.

Code
81013



Deckenrosette
Material:Kunststoff, farbe:Schwarz.

Code
81015



Klammer
L=35mm, H=14mm, D=24mm.
Material:Aluminium, farbe:poliert.

Finish
Anod. Al. **Code**
81086



Klammer
L=180mm, H=24mm, D=26mm.
Material:Aluminium, farbe:Eloxiertes Aluminium, bearbeitungstyp :Eloxierung.

Finish
Code
81024



Klammer

L=180mm, H=24mm, D=20mm.

Material:Aluminium, farbe:Weiß RAL 9010, bearbeitungstyp :Lackierung.

Finish

White

Code

81025



Klammer

L=180mm, H=24mm, D=20mm.

Material:Aluminium, farbe:Schwarz RAL 9005, bearbeitungstyp :Lackierung.

Finish

Black

Code

81026



Klammer

L=35mm, H=14mm, D=24mm.

Material:Aluminium, farbe:Weiß, bearbeitungstyp :Lackierung.

Finish

White

Code

81087



Klammer

L=35mm, H=14mm, D=24mm.

Material:Aluminium, farbe:Schwarz, bearbeitungstyp :Lackierung.

Finish

Black

Code

81088

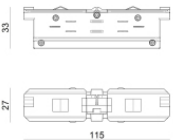

Kabelverbindung

Typ linear.

Material:PC, farbe:Weiß.

Finish

White

Code

81039

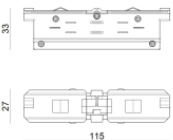

Kabelverbindung

Typ linear.

Material:PC, farbe:Schwarz.

Finish

Black

Code

81040



Kabelverbindung

Typ linear.

Material:PC, farbe:Weiß.

Finish

White

Code

81042

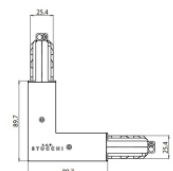

Kabelverbindung

Typ linear.

Material:PC, farbe:Weiß.

Finish

White

Code

81045



		<p>Kabelverbindung Typ linear. Material:PC, farbe:Weiß.</p>	<p>Finish White</p>	<p>Code 81048</p>
		<p>Kabelverbindung Typ flexible curve. Material:PC, farbe:Weiß.</p>	<p>Finish White</p>	<p>Code 81066</p>
		<p>Kabelverbindung Typ linear. Material:PC, farbe:Weiß.</p>	<p>Finish White</p>	<p>Code 81063</p>
		<p>Kabelverbindung Typ linear. Material:PC, farbe:Weiß.</p>	<p>Finish White</p>	<p>Code 81051</p>
		<p>Kabelverbindung Typ linear. Material:PC, farbe:Weiß.</p>	<p>Finish White</p>	<p>Code 81054</p>
		<p>Kabelverbindung Typ linear. Material:PC, farbe:Weiß.</p>	<p>Finish White</p>	<p>Code 81057</p>
		<p>Kabelverbindung Typ linear. Material:PC, farbe:Weiß.</p>	<p>Finish White</p>	<p>Code 81060</p>
		<p>Kabelverbindung Typ linear. Material:PC, farbe:Schwarz.</p>	<p>Finish Black</p>	<p>Code 81043</p>



		<p>Kabelverbindung Typ linear. Material:PC, farbe:Schwarz.</p>	<p>Finish Black</p>	<p>Code 81046</p>
		<p>Kabelverbindung Typ linear. Material:PC, farbe:Schwarz.</p>	<p>Finish Black</p>	<p>Code 81049</p>
		<p>Kabelverbindung Typ flexible curve. Material:PC, farbe:Schwarz.</p>	<p>Finish Black</p>	<p>Code 81067</p>
		<p>Kabelverbindung Typ linear. Material:PC, farbe:Schwarz.</p>	<p>Finish Black</p>	<p>Code 81064</p>
		<p>Kabelverbindung Typ linear. Material:PC, farbe:Schwarz.</p>	<p>Finish Black</p>	<p>Code 81052</p>
		<p>Kabelverbindung Typ linear. Material:PC, farbe:Schwarz.</p>	<p>Finish Black</p>	<p>Code 81055</p>
		<p>Kabelverbindung Typ linear. Material:PC, farbe:Schwarz.</p>	<p>Finish Black</p>	<p>Code 81058</p>
		<p>Kabelverbindung Typ linear. Material:PC, farbe:Schwarz.</p>	<p>Finish Black</p>	<p>Code 81061</p>



Hängeleuchten
Material:Kunststoff, farbe:Weiß.

Code
81006



Hängeleuchten
Material:Kunststoff, farbe:Weiß.

Code
81007

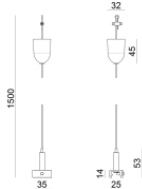

Hängeleuchten
Material:Kunststoff, farbe:Schwarz.

Code
81008

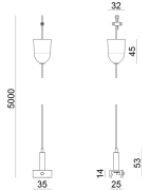

Hängeleuchten
Material:Kunststoff, farbe:Schwarz.

Code
81009



Hängeleuchten
Material:Kunststoff, farbe:Weiß.

Code
81018



Hängeleuchten
Material:Kunststoff, farbe:Schwarz.

Code
81019



Hängeleuchten
Material:Kunststoff, farbe:Weiß.

Code
81021



Hängeleuchten
Material:Kunststoff, farbe:Schwarz.

Code
81022



		<p>Drahtabdeckung Material:PC, farbe:Weiß.</p>	<p>Code <u>81069</u></p>
		<p>Drahtabdeckung Material:PC, farbe:Weiß.</p>	<p>Code <u>81072</u></p>
		<p>Drahtabdeckung Material:PC, farbe:Weiß.</p>	<p>Code <u>81075</u></p>
		<p>Drahtabdeckung Material:PC, farbe:Weiß.</p>	<p>Code <u>81078</u></p>
		<p>Drahtabdeckung Material:PC, farbe:Weiß.</p>	<p>Code <u>81081</u></p>
		<p>Drahtabdeckung Material:PC, farbe:Schwarz.</p>	<p>Code <u>81070</u></p>
		<p>Drahtabdeckung Material:PC, farbe:Schwarz.</p>	<p>Code <u>81073</u></p>
		<p>Drahtabdeckung Material:PC, farbe:Schwarz.</p>	<p>Code <u>81076</u></p>



		<p>Drahtabdeckung Material:PC, farbe:Schwarz.</p>	<p>Code <u>81079</u></p>
		<p>Drahtabdeckung Material:PC, farbe:Schwarz.</p>	<p>Code <u>81082</u></p>
		<p>Drahtabdeckung Material:Weiß.</p>	<p>Code <u>83249</u></p>
		<p>Drahtabdeckung Material:Schwarz, farbe:Schwarz.</p>	<p>Code <u>83250</u></p>
			<p>Code <u>81094</u></p>
			<p>Code <u>81091</u></p>
			<p>Code <u>81095</u></p>
			<p>Code <u>81093</u></p>



	Werkzeug	Code					
		81005					
		<p>Schiene Länge: 1000mm; Typ Schiene: Standard. Material:Aluminium, farbe:Weiß, bearbeitungstyp :Lackierung.</p>	<table border="1"> <thead> <tr> <th>Finish</th> <th>Code</th> </tr> </thead> <tbody> <tr> <td>White</td> <td>80990</td> </tr> </tbody> </table>	Finish	Code	White	80990
Finish	Code						
White	80990						
		<p>Schiene Länge: 2000mm; Typ Schiene: Standard. Material:Aluminium, farbe:Weiß, bearbeitungstyp :Lackierung.</p>	<table border="1"> <thead> <tr> <th>Finish</th> <th>Code</th> </tr> </thead> <tbody> <tr> <td>White</td> <td>80991</td> </tr> </tbody> </table>	Finish	Code	White	80991
Finish	Code						
White	80991						
		<p>Schiene Länge: 3000mm; Typ Schiene: Standard. Material:Aluminium, farbe:Weiß, bearbeitungstyp :Lackierung.</p>	<table border="1"> <thead> <tr> <th>Finish</th> <th>Code</th> </tr> </thead> <tbody> <tr> <td>White</td> <td>80992</td> </tr> </tbody> </table>	Finish	Code	White	80992
Finish	Code						
White	80992						
		<p>Schiene Länge: 1000mm; Typ Schiene: Standard. Material:Aluminium, farbe:Schwarz, bearbeitungstyp :Lackierung.</p>	<table border="1"> <thead> <tr> <th>Finish</th> <th>Code</th> </tr> </thead> <tbody> <tr> <td>Black</td> <td>80993</td> </tr> </tbody> </table>	Finish	Code	Black	80993
Finish	Code						
Black	80993						
		<p>Schiene Länge: 2000mm; Typ Schiene: Standard. Material:Aluminium, farbe:Schwarz, bearbeitungstyp :Lackierung.</p>	<table border="1"> <thead> <tr> <th>Finish</th> <th>Code</th> </tr> </thead> <tbody> <tr> <td>Black</td> <td>80994</td> </tr> </tbody> </table>	Finish	Code	Black	80994
Finish	Code						
Black	80994						
		<p>Schiene Länge: 3000mm; Typ Schiene: Standard. Material:Aluminium, farbe:Schwarz, bearbeitungstyp :Lackierung.</p>	<table border="1"> <thead> <tr> <th>Finish</th> <th>Code</th> </tr> </thead> <tbody> <tr> <td>Black</td> <td>80995</td> </tr> </tbody> </table>	Finish	Code	Black	80995
Finish	Code						
Black	80995						
		<p>Schiene Länge: 1000mm; Typ Schiene: Standard. Material:Aluminium, farbe:Weiß, bearbeitungstyp :Lackierung.</p>	<table border="1"> <thead> <tr> <th>Finish</th> <th>Code</th> </tr> </thead> <tbody> <tr> <td>White</td> <td>83336</td> </tr> </tbody> </table>	Finish	Code	White	83336
Finish	Code						
White	83336						



		<p>Schiene Länge: 2000mm; Typ Schiene: Standard. Material:Aluminium, farbe:Weiß, bearbeitungstyp :Lackierung.</p>	<table border="1"> <thead> <tr> <th>Finish</th> <th>Code</th> </tr> </thead> <tbody> <tr> <td>White</td> <td>83337</td> </tr> </tbody> </table>	Finish	Code	White	83337
Finish	Code						
White	83337						
		<p>Schiene Länge: 3000mm; Typ Schiene: Standard. Material:Aluminium, farbe:Weiß, bearbeitungstyp :Lackierung.</p>	<table border="1"> <thead> <tr> <th>Finish</th> <th>Code</th> </tr> </thead> <tbody> <tr> <td>White</td> <td>83338</td> </tr> </tbody> </table>	Finish	Code	White	83338
Finish	Code						
White	83338						
		<p>Schiene Länge: 1000mm; Typ Schiene: Standard. Material:Aluminium, farbe:Schwarz, bearbeitungstyp :Lackierung.</p>	<table border="1"> <thead> <tr> <th>Finish</th> <th>Code</th> </tr> </thead> <tbody> <tr> <td>Black</td> <td>83339</td> </tr> </tbody> </table>	Finish	Code	Black	83339
Finish	Code						
Black	83339						
		<p>Schiene Länge: 2000mm; Typ Schiene: Standard. Material:Aluminium, farbe:Schwarz, bearbeitungstyp :Lackierung.</p>	<table border="1"> <thead> <tr> <th>Finish</th> <th>Code</th> </tr> </thead> <tbody> <tr> <td>Black</td> <td>83340</td> </tr> </tbody> </table>	Finish	Code	Black	83340
Finish	Code						
Black	83340						
		<p>Schiene Länge: 3000mm; Typ Schiene: Standard. Material:Aluminium, farbe:Schwarz, bearbeitungstyp :Lackierung.</p>	<table border="1"> <thead> <tr> <th>Finish</th> <th>Code</th> </tr> </thead> <tbody> <tr> <td>Black</td> <td>83341</td> </tr> </tbody> </table>	Finish	Code	Black	83341
Finish	Code						
Black	83341						