

# Pound\_Wall

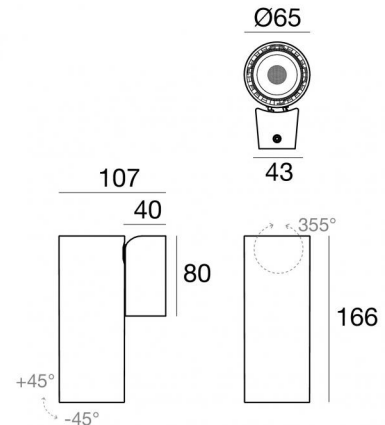

Wandleuchten | 100-264 V | 1 arrayLED 17.5 W DC - 19.5 W AC | CRI 90  
81997W30



Technische Daten	
Typ	Oberfläche
Installationsposition	Wand
Installationsumgebung	Indoor
Lichtquelle	LED
Circuit structure	arrayLED
Optik	Medium Flood
Light emission direction	downward
Lampe Nennleistung	17.5 W DC
Gesamtleistung	19.5 W
Lichtstrom (Lichtquelle)	2818 lm
Nominale Eingangsspannung	220 - 240 V AC
Eingangsspannungsbereich	100 - 264 V AC
Frequency	50 - 60 Hz
Ähnlichste Farbtemperatur / Tone	3000 K
Farbwiedergabeindex	90 Ra
Gleichstrom/Gleichspannung	AC
Isolierklasse	1
IP	IP20
Glühdrahtprüfung	850°
Direkte Montage auf normal entflammaren Oberflächen	Ja
CE	Ja
Einschließlich Driver	Driver
Leuchte dimmbar	Nein
Schwenkbarkeit	Orientabile
Gesamtwinkel (vertikale Ebene)	90 °
Gesamtwinkel (horizontale Ebene)	355 °
Drehbarkeit	Nein
Begehbarkeit	Nein
Überrollbarkeit	Nein
Einschließlich Kabel	Nein
Harzbeschichtung	Nein
Typ Lichtabstrahlung	Einflammig
Nettogewicht	0.8 Kg
Schutz vor elektrostatischen Entladungen	Ja
Schutz vor Stoßspannungen	1.85 KV
Optiktechnologie	Anti - Glare

Oberfläche Gehäuse	
Material	Stranggepresstes Aluminium EN AB - 46100
Farbe	Weiß
Bearbeitungstyp	Pulverbeschichtung

# Pound\_Wall



Wandleuchten | 100-264 V | 1 arrayLED 17.5 W DC - 19.5 W AC | CRI 90  
**81997W30**

Single emission wall lights for indoor application. The warm white LED light source with a medium flood light distribution is composed of 1 arrayed LEDs with CCT of 3000 K and a CRI 90; the source luminous flux is 2818 lm, with a 161.0 lm/W nominal luminous efficacy.

The device body is made of die-cast aluminium en ab - 46100 and features a white finish, processed by means of powder coating. The ingress protection degree is IP20; the total weight is of 0.8 kg.

The total absorbed power is 19.5 W.

The device features protection class I and can be wall lights-mounted.

Compliant with the EN 60598-1 standard and its specific provisions.

## Energieeffizienzklasse

ieses Produkt enthält eine Lichtquelle der Energieeffizienzklasse E.

## Illuminotechnical Eigenschaften

Lichtstrom (Lichtquelle)	2818 lm
Farbtemperatur	3000 K
Standard Deviation of Colour Matching	2 Step MacAdam
Farbwiedergabeindex	90 Ra
Colour Rendering Index	60 R9
Black Body Locus	On
Standardumgebungstemperatur	-20 / +50°C
Typische Temperatur am Glas	40°C

## LED Life / Failure Ratio

L70 B10 C0 252000h (at Tj 65 Ta 25 )

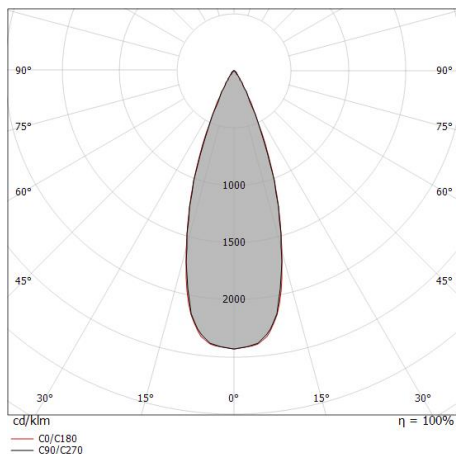





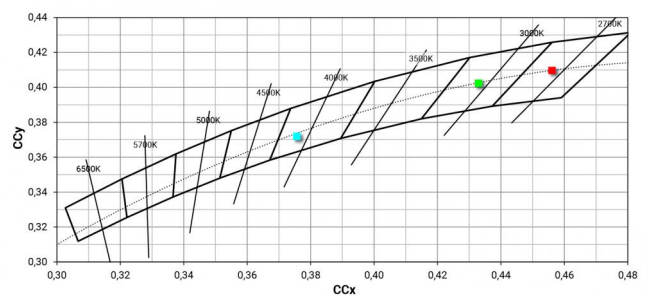

Distance [m]	Cone diameter [m]	illuminance [lx]
0.5	0.33	E(0°) 15389 E(C90) 18.3° 6597 E(C0) 18.4° 6624
1.0	0.66	E(0°) 3847 E(C90) 18.3° 1649 E(C0) 18.4° 1656
1.5	0.99	E(0°) 1710 E(C90) 18.3° 733 E(C0) 18.4° 736
2.0	1.32	E(0°) 962 E(C90) 18.3° 412 E(C0) 18.4° 414
2.5	1.65	E(0°) 616 E(C90) 18.3° 264 E(C0) 18.4° 265
3.0	1.98	E(0°) 427 E(C90) 18.3° 183 E(C0) 18.4° 184

— C0/C180 (Half-peak divergence: 36.8°)  
 — C90/C270 (Half-peak divergence: 36.6°)





	<p>Diffusor Diffusorart: filtro ellittico. Material:Pom-C, farbe:Schwarz.</p>	<p><b>Code</b> <u>99781</u></p>
	<p>Blendschutz Blendschutzart: wabenraster. Material:Pom-C, farbe:Schwarz.</p>	<p><b>Code</b> <u>99780</u></p>
	<p>Blendschutz Blendschutzart: frangiluce a croce. Material:Pom-C, farbe:Schwarz.</p>	<p><b>Code</b> <u>99779</u></p>
	<p>Blendschutz Blendschutzart: schermo cilindrico 45°. Material:Pom-C, farbe:Schwarz.</p>	<p><b>Code</b> <u>99782</u></p>
	<p>Optik Lichtverteilung: spot,Material Verkleidung: polycarbonat uv-beständige</p>	<p><b>Code</b> <u>99827</u></p>
	<p>Optik Lichtverteilung: medium flood,Material Verkleidung: ,polycarbonat uv- beständige,polycarbonat uv-beständige,polycarbonat uv-beständige</p>	<p><b>Code</b> <u>99828</u></p>
	<p>Optik Lichtverteilung: flood,Material Verkleidung: ,polycarbonat uv-beständige,polycarbonat uv- beständige,polycarbonat uv-beständige</p>	<p><b>Code</b> <u>99829</u></p>