

Pound_Wall

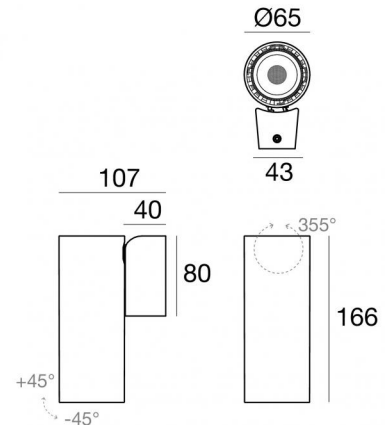

Wandleuchten | 100-264 V | 1 arrayLED 17.5 W DC - 19.5 W AC | CRI 90
81997W15



Technische Daten	
Typ	Oberfläche
Installationsposition	Wand
Installationsumgebung	Indoor
Lichtquelle	LED
Circuit structure	arrayLED
Optik	Spot
Light emission direction	downward
Lampe Nennleistung	17.5 W DC
Gesamtleistung	19.5 W
Lichtstrom (Lichtquelle)	2818 lm
Nominale Eingangsspannung	220 - 240 V AC
Eingangsspannungsbereich	100 - 264 V AC
Frequency	50 - 60 Hz
Ähnlichste Farbtemperatur / Tone	3000 K
Farbwiedergabeindex	90 Ra
Gleichstrom/Gleichspannung	AC
Isolierklasse	1
IP	IP20
Glühdrahtprüfung	850°
Direkte Montage auf normal entflammaren Oberflächen	Ja
CE	Ja
Einschließlich Driver	Driver
Leuchte dimmbar	Nein
Schwenkbarkeit	Orientabile
Gesamtwinkel (vertikale Ebene)	90 °
Gesamtwinkel (horizontale Ebene)	355 °
Drehbarkeit	Nein
Begehbarkeit	Nein
Überrollbarkeit	Nein
Einschließlich Kabel	Nein
Harzbeschichtung	Nein
Typ Lichtabstrahlung	Einflammig
Nettogewicht	0.8 Kg
Schutz vor elektrostatischen Entladungen	Ja
Schutz vor Stoßspannungen	1.85 KV
Optiktechnologie	Anti - Glare

Oberfläche Gehäuse	
Material	Stranggepresstes Aluminium EN AB - 46100
Farbe	Weiß
Bearbeitungstyp	Pulverbeschichtung



Wandleuchten | 100-264 V | 1 arrayLED 17.5 W DC - 19.5 W AC | CRI 90
81997W15

Single emission wall lights for indoor application. The warm white LED light source with a spot light distribution is composed of 1 arrayed LEDs with CCT of 3000 K and a CRI 90; the source luminous flux is 2818 lm, with a 161.0 lm/W nominal luminous efficacy.

The device body is made of die-cast aluminium en ab - 46100 and features a white finish, processed by means of powder coating. The ingress protection degree is IP20; the total weight is of 0.8 kg.

The total absorbed power is 19.5 W.

The device features protection class I and can be wall lights-mounted.

Compliant with the EN 60598-1 standard and its specific provisions.

Energieeffizienzklasse

ieses Produkt enthält eine Lichtquelle der Energieeffizienzklasse E.

Illuminotechnical Eigenschaften

Light Output Ratio (LOR)	69 %
Lichtstrom (Lichtquelle)	2818 lm
Leuchten Lichtstrom	1964 lm
Consumption	19.5 W
Leuchten Lichtausbeute	100 lm/W
Farbtemperatur	3000 K
Standard Deviation of Colour Matching	2 Step MacAdam
Farbwiedergabeindex	90 Ra
Colour Rendering Index	60 R9
Black Body Locus	On
Standardumgebungstemperatur	-20 / +50°C
Typische Temperatur am Glas	40°C

LED Life / Failure Ratio

L70 B10 C0 252000h (at Tj 65 Ta 25)

UGR

UGR axial	17.2
UGR transversal	17.2
X=4H Y=8H	S=0.25H
Reflection factor	70/50/20

OPTICAL

Optik C0/C180	19°
Light distribution simmetry	Symmetrical

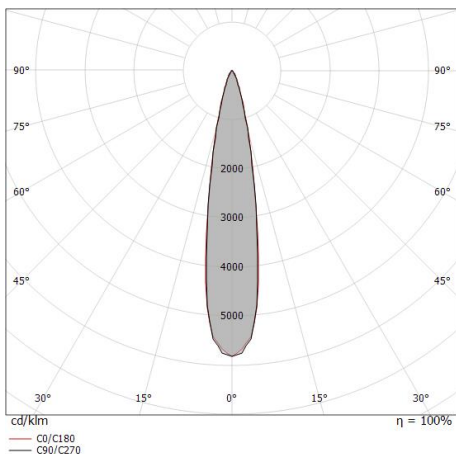







Distance [m]	Cone diameter [m]	illuminance [lx]
0.5	0.17 0.17	E(0°) 45732 E(C90) 9.7° 21955 E(C0) 9.8° 21929
1.0	0.34 0.35	E(0°) 11433 E(C90) 9.7° 5489 E(C0) 9.8° 5482
1.5	0.51 0.52	E(0°) 5081 E(C90) 9.7° 2439 E(C0) 9.8° 2437
2.0	0.68 0.69	E(0°) 2858 E(C90) 9.7° 1372 E(C0) 9.8° 1371
2.5	0.85 0.86	E(0°) 1829 E(C90) 9.7° 878 E(C0) 9.8° 877
3.0	1.03 1.04	E(0°) 1270 E(C90) 9.7° 610 E(C0) 9.8° 609

— C0/C180 (Half-peak divergence: 19.6°)
 — C90/C270 (Half-peak divergence: 19.4°)

COLOR VECTOR GRAPHIC

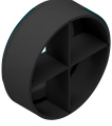



	<p>Diffusor Diffusorart: filtro ellittico. Material:Pom-C, farbe:Schwarz.</p>	<p>Code <u>99781</u></p>
	<p>Blendschutz Blendschutzart: wabenraster. Material:Pom-C, farbe:Schwarz.</p>	<p>Code <u>99780</u></p>
	<p>Blendschutz Blendschutzart: frangiluce a croce. Material:Pom-C, farbe:Schwarz.</p>	<p>Code <u>99779</u></p>
	<p>Blendschutz Blendschutzart: schermo cilindrico 45°. Material:Pom-C, farbe:Schwarz.</p>	<p>Code <u>99782</u></p>
	<p>Optik Lichtverteilung: spot,Material Verkleidung: polycarbonat uv-beständige</p>	<p>Code <u>99827</u></p>
	<p>Optik Lichtverteilung: medium flood,Material Verkleidung: ,polycarbonat uv- beständige,polycarbonat uv-beständige,polycarbonat uv-beständige</p>	<p>Code <u>99828</u></p>
	<p>Optik Lichtverteilung: flood,Material Verkleidung: ,polycarbonat uv-beständige,polycarbonat uv- beständige,polycarbonat uv-beständige</p>	<p>Code <u>99829</u></p>