

Prolamp RGBW

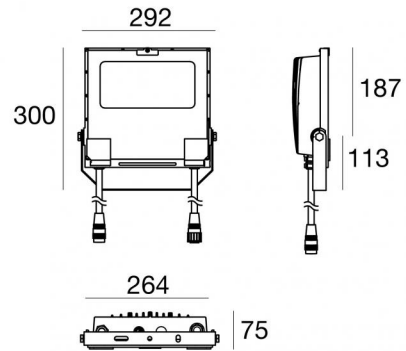

Scheinwerfer | 8 x powerLEDs 59 W DC 48 V
 RGBW - 3000
81949V25



Technische Daten	
Typ	Oberfläche
Installationsposition	Wand - Decke - Boden
Installationsumgebung	Outdoor
Lichtquelle	LED
Circuit structure	powerLEDs
Optik	Oval
Light emission direction	frontal
Lampe Nennleistung	59 W DC
Ähnlichste Farbtemperatur / Tone	RGBW - 3000 K
Gleichstrom/Gleichspannung	CV
Isolierklasse	3
IP	IP67
IK	IK08
Glühdrahtprüfung	850°
Direkte Montage auf normal entflammaren Oberflächen	Ja
CE	Ja
Einschließlich Driver	Control unit
Leuchte dimmbar	DMX-RDM
Schwenkbarkeit	Orientabile
Gesamtwinkel (vertikale Ebene)	180 °
Drehbarkeit	Nein
Begehbarkeit	Nein
Überrollbarkeit	Nein
Einschließlich Kabel	Ja
Kabellänge	0.3 m
Harzbeschichtung	Nein
Typ Lichtabstrahlung	Einflammig
Nettogewicht	3.8 Kg
Schutz vor elektrostatischen Entladungen	Ja
Schutz vor Stoßspannungen	4 KV
Technische Merkmale des Produkts	TCS

Oberfläche Gehäuse

Material	Stranggepresstes Aluminium EN AB - 46100
Farbe	Schwarz
Bearbeitungstyp	Offenporige Anodisierung + Pulverlackierung

Oberfläche Diffusor

Material	Extra-helles Glas - Gehärtet
Farbe	transparent
Bearbeitungstyp	Siebdruck

Oberfläche bügel

Material	Stahl AISI 304
Farbe	Stahl

Elektronik

	99785 On/Off Driver 100~305V AC / 142~431V DC 240 W (- art.)
---	---

	C-E700026 DMX Controller (- art.)
---	--------------------------------------

Cables Electrification+signal

IP (locked condition)	67
Cable connector	AllinONE Male Plug 6 Pin
Cable connector	ALLinONE Female Socket 6 Pin

Lumen RGBW

N. Led	Rot	Grün	Blau	Weiß
8	592 lm	968 lm	168 lm	976 lm

Prolamp RGBW



Scheinwerfer | 8 x powerLEDs 59 W DC 48 V | RGBW - 3000
81949V25

Single emission projectors for outdoor application. The RGBW - 3000 K LED light source with a elliptic light distribution is composed of 8 powerled LEDs with CCT of RGB-W 3000 K.

The device body is made of die-cast aluminium en ab - 46100 and features a black finish, processed by means of open pore anodizing + powder coating; the diffuser is made of extra clear glass - tempered with a silk-screening treatment. The ingress protection degree is IP67; the total weight is of 3.8 kg.

The total absorbed power is 59 W. The power supply cable is included and features a 0.3 m length.

The device features protection class III and can be wall lights, ceiling or floor-mounted.

Compliant with the EN 60598-1 standard and its specific provisions.

Energieeffizienzklasse

ieses Produkt enthält eine Lichtquelle der Energieeffizienzklasse G.









Standardumgebungstemperatur	-20 / +50°C
-----------------------------	-------------

Typische Temperatur am Glas	40°C
-----------------------------	------

LED Life / Failure Ratio

L70 B10 C0 202460h (at Tj 60 Ta 25)



<p>L. 1m</p> 	<p>Kabel und Stecker Typ Kabel power + signal cable allinone; Länge 1000 mm; isolierung doppio con schermatura per segnale; außendurchmesser: 12.6 mm; farben: weiß - blau - rot - grau - braun - gelb-grün.</p>	<p>Code <u>98660</u></p>
<p>L. 5m</p> 	<p>Kabel und Stecker Typ Kabel power + signal cable allinone; Länge 5000 mm; isolierung doppio con schermatura per segnale; außendurchmesser: 12.6 mm; farben: weiß - blau - rot - grau - braun - gelb-grün.</p>	<p>Code <u>98661</u></p>
<p>L. 1m</p> 	<p>Kabel und Stecker Typ Kabel power + signal cable allinone; Länge 1000 mm; isolierung doppio con schermatura per segnale; außendurchmesser: 12.6 mm.</p>	<p>Code <u>98662</u></p>
<p>L. 5m</p> 	<p>Kabel und Stecker Typ Kabel power + signal cable allinone; Länge 5000 mm; isolierung doppio con schermatura per segnale; außendurchmesser: 12.6 mm.</p>	<p>Code <u>98663</u></p>
 	<p>Stecker - Start splitter Typ Kabel power + signal cable allinone; Länge 5000 + 5000 + 200 mm; isolierung doppio con schermatura per segnale.</p>	<p>Code <u>98985</u></p>
 	<p>Stecker - Continuity splitter Typ Kabel power + signal cable allinone; Länge 200 + 200 + 5000 mm; isolierung doppio con schermatura per segnale.</p>	<p>Code <u>99390</u></p>
	<p>Stecker - DMX-Leitungsverschlussadapter für ALLinONE-Kabel Typ Kabel power + signal cable allinone; ; isolierung doppio con schermatura per segnale.</p>	<p>Code <u>98986</u></p>