

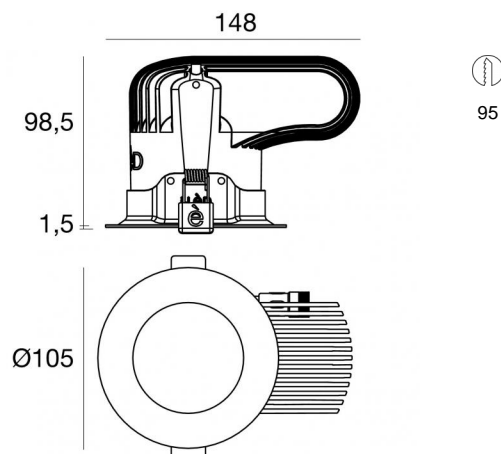

Downlights | 1 arrayLED 25 W DC 700 mA | CRI 90
80808W60



Technische Daten	
Installationsposition	Decke
Installationsumgebung	Indoor
Lichtquelle	LED
Circuit structure	arrayLED
Optik	Medium Wide Flood
Light emission direction	downward
Lampe Nennleistung	25 W DC
Lichtstrom (Lichtquelle)	4134 lm
Eingangsspannungsbereich	700mA
Ähnlichste Farbtemperatur / Tone	3000 K
Farbwiedergabeindex	90 Ra
Gleichstrom/Gleichspannung	CC
Isolierklasse	3
IP	IP44
IP optisches System	IP65
IK	IK08
Glühdrahtprüfung	850°
Direkte Montage auf normal entflammaren Oberflächen	Ja
CE	Ja
Einschließlich Driver	Nein
Leuchte dimmbar	DALI - 1-10V
Schwenkbarkeit	Nein
Drehbarkeit	Nein
Begehbarkeit	Nein
Überrollbarkeit	Nein
Einschließlich Kabel	Ja
Kabellänge	0.300 m
Harzbeschichtung	Nein
Typ Lichtabstrahlung	Einflammig
Nettogewicht	0.68 Kg
Schutz vor elektrostatischen Entladungen	Nein
Schutz vor Stoßspannungen	Nein
Optiktechnologie	Honey comb

Oberfläche Gehäuse	
Material	Stranggepresstes Aluminium EN AB - 46100
Farbe	Schwarz
Bearbeitungstyp	Pulverbeschichtung

Oberfläche Diffusor	
Material	Polycarbonat UV-beständige
Farbe	transparent

Oberfläche strahler	
Material	Stranggepresstes Aluminium EN AB - 46100
Farbe	Aluminium
Bearbeitungstyp	Polieren

Elektronik

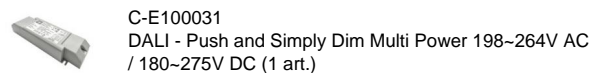
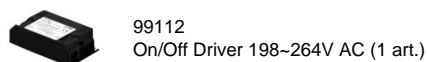

Cables Electrification	
Cable connector	Male Easy plug
IP (locked condition)	66
Cable connector	Female Easy plug

Downlights | 1 arrayLED 25 W DC 700 mA | CRI 90 80808W60

Single emission recessed downlights for indoor application. The warm white LED light source with a medium wide flood light distribution is composed of 1 arrayed LEDs with CCT of 3000 K and a CRI 90; the source luminous flux is 4134 lm, with a 165.4 lm/W nominal luminous efficacy.

The device body is made of die-cast aluminium en ab - 46100 and features a black finish, processed by means of powder coating; the diffuser is made of uv resistant polycarbonate. The ingress protection degree is IP44; the total weight is of 0.68 kg. The power supply driver is not provided and is to be ordered separately.

The total absorbed power is 25 W. The power supply cable is included and features a 0.300 m length.

The device features protection class III and can be ceiling-mounted, with a 95 mm diameter hole (in plasterboard).

Compliant with the EN 60598-1 standard and its specific provisions.

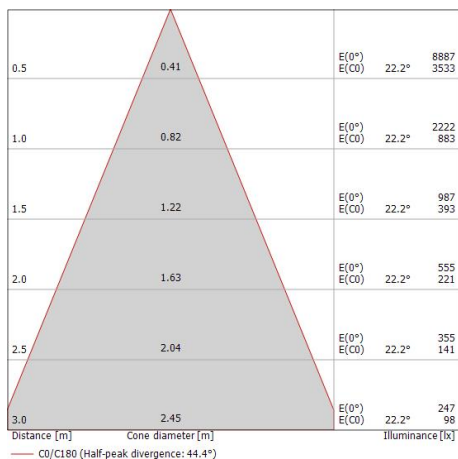
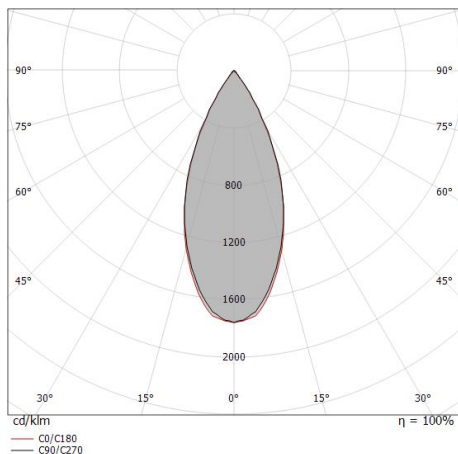

Energieeffizienzklasse

ieses Produkt enthält eine Lichtquelle der Energieeffizienzklasse E.

Illuminotechnical Eigenschaften

Light Output Ratio (LOR)	30 %
Lichtstrom (Lichtquelle)	4134 lm
Leuchten Lichtstrom	1262 lm
Consumption	18 W
Leuchten Lichtausbeute	70 lm/W
Farbtemperatur	3000 K
Standard Deviation of Colour Matching	2 Step MacAdam
Farbwiedergabeindex	90 Ra
Standardumgebungstemperatur	-20 / +50°C
Typische Temperatur am Glas	40°C

LED Life / Failure Ratio

L70 B10 C0 252000h (at Tj 65 Ta 25)

UGR

UGR transversal	14.3
UGR axial	14.8
X=4H Y=8H	S=0.25H
Reflection factor	70/50/20

OPTICAL

Optik C0/C180	44°
Light distribution simmetry	Symmetrical

Downlights | 1 arrayLED 25 W DC 700 mA | CRI 90

80808W60

Single emission recessed downlights for indoor application. The warm white LED light source with a medium wide flood light distribution is composed of 1 arrayed LEDs with CCT of 3000 K and a CRI 90; the source luminous flux is 4134 lm, with a 165.4 lm/W nominal luminous efficacy.

The device body is made of die-cast aluminium en ab - 46100 and features a black finish, processed by means of powder coating; the diffuser is made of uv resistant polycarbonate. The ingress protection degree is IP44; the total weight is of 0.68 kg. The power supply driver is not provided and is to be ordered separately.

The total absorbed power is 25 W. The power supply cable is included and features a 0.300 m length.

The device features protection class III and can be ceiling-mounted, with a 95 mm diameter hole (in plasterboard).

Compliant with the EN 60598-1 standard and its specific provisions.

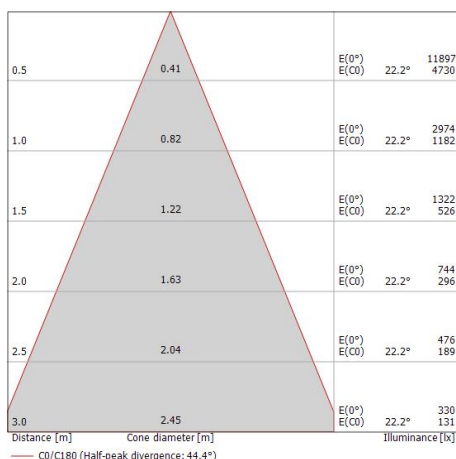
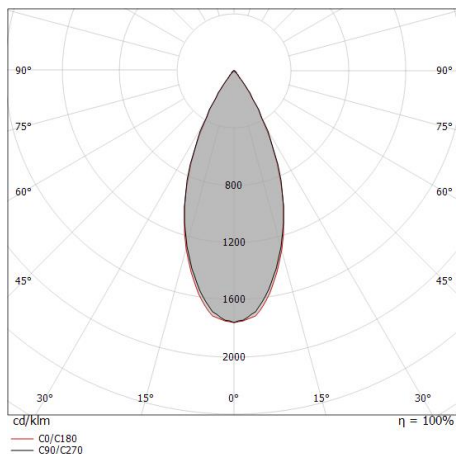

Energieeffizienzklasse

ieses Produkt enthält eine Lichtquelle der Energieeffizienzklasse E.

Illuminotechnical Eigenschaften

Light Output Ratio (LOR)	40 %
Lichtstrom (Lichtquelle)	4134 lm
Leuchten Lichtstrom	1690 lm
Consumption	25 W
Leuchten Lichtausbeute	67 lm/W
Farbtemperatur	3000 K
Standard Deviation of Colour Matching	2 Step MacAdam
Farbwiedergabeindex	90 Ra
Standardumgebungstemperatur	-20 / +50°C
Typische Temperatur am Glas	40°C

LED Life / Failure Ratio

L70 B10 C0 252000h (at Tj 65 Ta 25)

UGR

UGR transversal	15.3
UGR axial	15.8
X=4H Y=8H	S=0.25H
Reflection factor	70/50/20

OPTICAL

Optik C0/C180	44°
Light distribution simmetry	Symmetrical